

## Notice for TAIYO YUDEN products

---

Please read this notice before using the TAIYO YUDEN products.

### REMINDERS

- Product information in this catalog is as of October 2013. All of the contents specified herein are subject to change without notice due to technical improvements, etc. Therefore, please check for the latest information carefully before practical application or usage of the Products.

Please note that TAIYO YUDEN CO., LTD. shall not be responsible for any defects in products or equipment incorporating such products, which are caused under the conditions other than those specified in this catalog or individual specification.

- Please contact TAIYO YUDEN CO., LTD. for further details of product specifications as the individual specification is available.

- Please conduct validation and verification of products in actual condition of mounting and operating environment before commercial shipment of the equipment.

- All electronic components or functional modules listed in this catalog are developed, designed and intended for use in general electronics equipment.(for AV, office automation, household, office supply, information service, telecommunications, (such as mobile phone or PC) etc.). Before incorporating the components or devices into any equipment in the field such as transportation,( automotive control, train control, ship control), transportation signal, disaster prevention, medical, public information network (telephone exchange, base station) etc. which may have direct influence to harm or injure a human body, please contact TAIYO YUDEN CO., LTD. for more detail in advance.

Do not incorporate the products into any equipment in fields such as aerospace, aviation, nuclear control, submarine system, military, etc. where higher safety and reliability are especially required.

In addition, even electronic components or functional modules that are used for the general electronic equipment, if the equipment or the electric circuit require high safety or reliability function or performances, a sufficient reliability evaluation check for safety shall be performed before commercial shipment and moreover, due consideration to install a protective circuit is strongly recommended at customer's design stage.

- The contents of this catalog are applicable to the products which are purchased from our sales offices or distributors (so called "TAIYO YUDEN' s official sales channel").

It is only applicable to the products purchased from any of TAIYO YUDEN' s official sales channel.

- Please note that TAIYO YUDEN CO., LTD. shall have no responsibility for any controversies or disputes that may occur in connection with a third party's intellectual property rights and other related rights arising from your usage of products in this catalog. TAIYO YUDEN CO., LTD. grants no license for such rights.

- Caution for export

Certain items in this catalog may require specific procedures for export according to "Foreign Exchange and Foreign Trade Control Law" of Japan, "U.S. Export Administration Regulations", and other applicable regulations. Should you have any question or inquiry on this matter, please contact our sales staff.

# MULTILAYER CERAMIC CAPACITORS

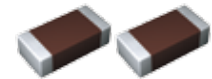

WAVE

REFLOW

## PARTS NUMBER

|   |   |   |   |   |   |   |   |   |   |   |   |   |   |   |   |   |
|---|---|---|---|---|---|---|---|---|---|---|---|---|---|---|---|---|
| J | M | K | 3 | 1 | 6 | △ | B | J | 1 | 0 | 6 | M | L | - | T | △ |
| ① | ② | ③ | ④ | ⑤ | ⑥ | ⑦ | ⑧ | ⑨ | ⑩ | ⑪ | ⑫ |   |   |   |   |   |

△=Blank space

### ① Rated voltage

| Code | Rated voltage [VDC] |
|------|---------------------|
| P    | 2.5                 |
| A    | 4                   |
| J    | 6.3                 |
| L    | 10                  |
| E    | 16                  |
| T    | 25                  |
| G    | 35                  |
| U    | 50                  |
| H    | 100                 |
| Q    | 250                 |
| S    | 630                 |

### ② Series name

| Code | Series name                                     |
|------|---|
| M    | Multilayer ceramic capacitor                    |
| V    | Multilayer ceramic capacitor for high frequency |
| W    | LW reverse type multilayer capacitor            |

### ③ End termination

| Code | End termination        |
|------|------------------------|
| K    | Plated                 |
| S    | Cu Internal Electrodes |

### ④ Dimension (L × W)

| Type | Dimensions (L × W) [mm] | EIA (inch) |
|------|-------------------------|------------|
| 042  | 0.4 × 0.2               | 01005      |
| 063  | 0.6 × 0.3               | 0201       |
| 105  | 1.0 × 0.5               | 0402       |
|      | 0.52 × 1.0 ※            | 0204       |
| 107  | 1.6 × 0.8               | 0603       |
|      | 0.8 × 1.6 ※             | 0306       |
| 212  | 2.0 × 1.25              | 0805       |
|      | 1.25 × 2.0 ※            | 0508       |
| 316  | 3.2 × 1.6               | 1206       |
| 325  | 3.2 × 2.5               | 1210       |
| 432  | 4.5 × 3.2               | 1812       |

Note : ※LW reverse type (□WK) only

### ⑤ Dimension tolerance

| Code         | Type     | L [mm]         | W [mm]          | T [mm]          |
|--------------|----------|----------------|-----------------|-----------------|
| △            | ALL      | Standard       | Standard        | Standard        |
| A            | 063      | 0.6±0.05       | 0.3±0.05        | 0.3±0.05        |
|              | 105      | 1.0±0.10       | 0.5±0.10        | 0.5±0.10        |
|              | 107      | 1.6+0.15/-0.05 | 0.8+0.15/-0.05  | 0.8+0.15/-0.05  |
|              | 212      | 2.0+0.15/-0.05 | 1.25+0.15/-0.05 | 0.45±0.05       |
|              |          |                |                 | 0.85±0.10       |
|              |          |                |                 | 1.25+0.15/-0.05 |
| 316          | 3.2±0.20 | 1.25±0.20      | 0.85±0.10       |                 |
| 325          | 3.2±0.30 | 2.5±0.30       | 1.6±0.20        |                 |
| B            | 105      | 1.0+0.15/-0.05 | 0.5+0.15/-0.05  | 0.5+0.15/-0.05  |
|              | 107      | 1.6+0.20/-0    | 0.8+0.20/-0     | 0.45±0.05       |
|              |          |                |                 | 0.8+0.20/-0     |
|              | 212      | 2.0+0.20/-0    | 1.25+0.20/-0    | 0.85±0.10       |
| 1.25+0.20/-0 |          |                |                 |                 |
| 316          | 3.2±0.30 | 1.6±0.30       | 1.6±0.30        |                 |
| C            | 105      | 1.0+0.20/-0    | 0.5+0.20/-0     | 0.5+0.20/-0     |
|              |          |                |                 | 0.5+0.20/-0     |

Note: P.6 Standard external dimensions

△= Blank space

### ⑥ Temperature characteristics code

#### ■ High dielectric type (Excluding Super low distortion multilayer ceramic capacitor (CFCAP™))

| Code  | Applicable standard |     | Temperature range [°C] | Ref. Temp. [°C] | Capacitance change | Capacitance tolerance | Tolerance code |
|-------|---------------------|-----|------------------------|-----------------|--------------------|-----------------------|----------------|
| BJ    | JIS                 | B   | -25~+85                | 20              | ±10%               | ±10%                  | K              |
|       |                     |     |                        |                 |                    | ±20%                  | M              |
|       | EIA                 | X5R | -55~+85                | 25              | ±15%               | ±10%                  | K              |
| B7    | EIA                 | X7R | -55~+125               | 25              | ±15%               | ±20%                  | M              |
|       |                     |     |                        |                 |                    | ±10%                  | K              |
| C6    | EIA                 | X6S | -55~+105               | 25              | ±22%               | ±10%                  | K              |
|       |                     |     |                        |                 |                    | ±20%                  | M              |
| C7    | EIA                 | X7S | -55~+125               | 25              | ±22%               | ±10%                  | K              |
|       |                     |     |                        |                 |                    | ±20%                  | M              |
| LD(※) | EIA                 | X5R | -55~+85                | 25              | ±15%               | ±10%                  | K              |
|       |                     |     |                        |                 |                    | ±20%                  | M              |
| △F    | JIS                 | F   | -25~+85                | 20              | +30/-80%           | +80/-20%              | Z              |
|       | EIA                 | Y5V | -30~+85                | 25              | +22/-82%           | +80/-20%              | Z              |

Note : ※.LD Low distortion high value multilayer ceramic capacitor

△= Blank space

▶ This catalog contains the typical specification only due to the limitation of space. When you consider the purchase of our products, please check our specification. For details of each product (characteristics graph, reliability information, precautions for use, and so on), see our Web site (<http://www.ty-top.com/>).

■Temperature compensating type

| Code | Applicable standard |     | Temperature range [°C] | Ref. Temp. [°C] | Capacitance change | Capacitance tolerance | Tolerance code |
|------|---------------------|-----|------------------------|-----------------|--------------------|-----------------------|----------------|
| CG   | EIA                 | C0G | -55~+125               | 25              | 0±60ppm/°C         | ±0.1pF                | B              |
|      |                     |     |                        |                 |                    | ±0.25pF               | C              |
|      |                     |     |                        |                 |                    | ±0.5pF                | D              |
|      |                     |     |                        |                 |                    | ±1pF                  | F              |
|      |                     |     |                        |                 |                    | ±5%                   | J              |
| CH   | JIS                 | CH  | -55~+125               | 20              | 0±60ppm/°C         | ±0.1pF                | B              |
|      |                     |     |                        |                 |                    | ±0.25pF               | C              |
|      |                     |     |                        |                 |                    | ±0.5pF                | D              |
|      | EIA                 | C0H |                        | 25              |                    | ±1pF                  | F              |
|      |                     |     |                        |                 |                    | ±5%                   | J              |
|      |                     |     |                        |                 |                    | ±10%                  | K              |
| CJ   | JIS                 | CJ  | -55~+125               | 20              | 0±120ppm/°C        | ±0.25pF               | C              |
|      | EIA                 | C0J |                        | 25              |                    |                       |                |
| CK   | JIS                 | CK  | -55~+125               | 20              | 0±250ppm/°C        | ±0.25pF               | C              |
|      | EIA                 | C0J |                        | 25              |                    |                       |                |
| UJ   | JIS                 | UJ  | -55~+125               | 20              | -750±120ppm/°C     | ±0.25pF               | C              |
|      | EIA                 | U2J |                        | 25              |                    | ±0.5pF                | D              |
| UK   | JIS                 | UK  | -55~+125               | 20              | -750±250ppm/°C     | ±0.5pF                | C              |
|      | EIA                 | U2K | -55~+125               | 25              |                    |                       |                |
| SL   | JIS                 | SL  | -55~+125               | 20              | +350~-1000ppm/°C   | ±5%                   | J              |

⑥Series code

(Super low distortion multilayer ceramic capacitor(CFCAP™) only)

| Code | Series code |
|------|-------------|
| SD   | Standard    |

⑦Nominal capacitance

| Code (example) | Nominal capacitance |
|----------------|---------------------|
| 0R5            | 0.5pF               |
| 010            | 1pF                 |
| 100            | 10pF                |
| 101            | 100pF               |
| 102            | 1,000pF             |
| 103            | 10,000pF            |
| 104            | 0.1 μF              |
| 105            | 1.0 μF              |
| 106            | 10 μF               |
| 107            | 100 μF              |

Note : R=Decimal point

⑧Capacitance tolerance

| Code | Capacitance tolerance |
|------|-----------------------|
| B    | ±0.1pF                |
| C    | ±0.25pF               |
| D    | ±0.5pF                |
| F    | ±1pF                  |
| G    | ±2%                   |
| J    | ±5%                   |
| K    | ±10%                  |
| M    | ±20%                  |
| Z    | +80/-20%              |

⑨Thickness

| Code | Thickness [mm]        |
|------|-----------------------|
| C    | 0.2                   |
| D    |                       |
| P    |                       |
| T    | 0.3                   |
| K    |                       |
| V    | 0.5                   |
| W    |                       |
| A    | 0.8                   |
| D    | 0.85(212type or more) |
| F    | 1.15                  |
| G    | 1.25                  |
| L    | 1.6                   |
| N    | 1.9                   |
| Y    | 2.0 max               |
| M    | 2.5                   |

⑩Special code

| Code | Special code |
|------|--------------|
| -    | Standard     |

⑪Packaging

| Code | Packaging  |
|------|--|
| F    | φ 178mm Taping (2mm pitch)   |
| T    | φ 178mm Taping (4mm pitch)   |
| P    | φ 178mm Taping (4mm pitch, 1000 pcs/reel)<br>325 type (Thickness code M) |
| W    | φ 178mm Taping (1mm pitch) 042type only                                  |

⑫Internal code

| Code | Internal code |
|------|---------------|
| △    | Standard      |

► This catalog contains the typical specification only due to the limitation of space. When you consider the purchase of our products, please check our specification. For details of each product (characteristics graph, reliability information, precautions for use, and so on), see our Web site (<http://www.ty-top.com/>).

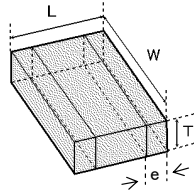
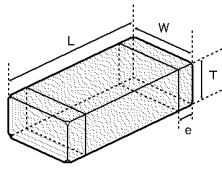

※ LW reverse type

| Type( EIA )   | Dimension [mm] |           |  |                       |                |
|---------------|----------------|-----------|--|-----------------------|----------------|
|               | L              | W         | T  | *1                    | e              |
| □MK042(01005) | 0.4±0.02       | 0.2±0.02  | 0.2±0.02   | C<br>D                | 0.1±0.03       |
| □VS042(01005) | 0.4±0.02       | 0.2±0.02  | 0.2±0.02   | C                     | 0.1±0.03       |
| □MK063(0201)  | 0.6±0.03       | 0.3±0.03  | 0.3±0.03   | P<br>T                | 0.15±0.05      |
| □MK105(0402)  | 1.0±0.05       | 0.5±0.05  | 0.2±0.02<br>0.3±0.03<br>0.5±0.05                               | C<br>P<br>V           | 0.25±0.10      |
| □VK105(0402)  | 1.0±0.05       | 0.5±0.05  | 0.5±0.05   | W                     | 0.25±0.10      |
| □WK105(0204)※ | 0.52±0.05      | 1.0±0.05  | 0.3±0.05   | P                     | 0.18±0.08      |
| □MK107(0603)  | 1.6±0.10       | 0.8±0.10  | 0.45±0.05<br>0.8±0.10  | K<br>A                | 0.35±0.25      |
| □WK107(0306)※ | 0.8±0.10       | 1.6±0.10  | 0.5±0.05   | V                     | 0.25±0.15      |
| □MK212(0805)  | 2.0±0.10       | 1.25±0.10 | 0.45±0.05<br>0.85±0.10<br>1.25±0.10                            | K<br>D<br>G           | 0.5±0.25       |
| □WK212(0508)※ | 1.25±0.15      | 2.0±0.15  | 0.85±0.1   | D                     | 0.3±0.2        |
| □MK316(1206)  | 3.2±0.15       | 1.6±0.15  | 0.85±0.10<br>1.15±0.10<br>1.25±0.10<br>1.6±0.20                | D<br>F<br>G<br>L      | 0.5+0.35/-0.25 |
| □MK325(1210)  | 3.2±0.30       | 2.5±0.20  | 0.85±0.10<br>1.15±0.10<br>1.9±0.20<br>1.9+0.1/-0.2<br>2.5±0.20 | D<br>F<br>N<br>Y<br>M | 0.6±0.3        |
| □MK432(1812)  | 4.5±0.40       | 3.2±0.30  | 2.5±0.20   | M                     | 0.9±0.6        |

Note : ※. LW reverse type, \*1.Thickness code

■ STANDARD QUANTITY

| Type   | EIA (inch) | Dimension |      | Standard quantity [pcs] |                 |
|--------|------------|-----------|------|-------------------------|-----------------|
|        |            | [mm]      | Code | Paper tape              | Embossed tape   |
| 042    | 01005      | 0.2       | C    | —                       | 40000           |
|        |            |           | D    |                         |                 |
| 063    | 0201       | 0.3       | P    | 15000                   | —               |
|        |            |           | T    |                         |                 |
| 105    | 0402       | 0.2       | C    | 20000                   | —               |
|        |            |           | P    |                         |                 |
|        |            |           | V    |                         |                 |
|        |            |           | W    |                         |                 |
| 0204 ※ | 0.30       | 0.30      | P    | 10000                   | —               |
|        |            |           | P    |                         |                 |
| 107    | 0603       | 0.45      | K    | 4000                    | —               |
|        |            |           | A    |                         |                 |
|        |            |           | V    |                         |                 |
| 0306 ※ | 0.50       | 0.50      | V    | —                       | 4000            |
|        |            |           | V    |                         |                 |
| 212    | 0805       | 0.45      | K    | 4000                    | —               |
|        |            |           | D    |                         |                 |
|        |            |           | G    |                         |                 |
|        |            |           | D    |                         |                 |
| 0508 ※ | 0.85       | 0.85      | D    | 4000                    | —               |
|        |            |           | D    |                         |                 |
| 316    | 1206       | 0.85      | D    | 4000                    | —               |
|        |            |           | F    |                         |                 |
|        |            |           | G    |                         |                 |
|        |            |           | L    |                         |                 |
| 325    | 1210       | 0.85      | D    | —                       | 2000            |
|        |            |           | F    |                         |                 |
|        |            |           | N    |                         |                 |
|        |            |           | Y    |                         |                 |
|        |            |           | M    |                         |                 |
| 432    | 1812       | 2.5       | M    | —                       | 500(T), 1000(P) |
|        |            |           | M    |                         | 500             |

Note : ※.LW Reverse type (□WK)

■ PARTS NUMBER

[Temperature Characteristic SD : Standard] 1.15mm thickness(F)

| Part number 1    | Part number 2 | Rated voltage [V] | Temperature characteristics |  |  | Capacitance [F] | Capacitance tolerance [%] | tan δ [%] | HTLT              | Thickness*3 [mm] | Soldering R:Reflow W:Wave |
|------------------|---------------|-------------------|-----------------------------|--|--|-----------------|---------------------------|-----------|-------------------|------------------|---------------------------|
|                  |               |                   |                             |  |  |                 |                           |           | Rated voltage x % |                  |                           |
| GMK316 SD333KF-T |               | 35                | Standard Type               |  |  | 33000 p         | ±10                       | 0.1       | 200               | 1.15±0.10        | R                         |
| GMK316 SD393KF-T |               |                   |                             |  |  | 39000 p         | ±10                       | 0.1       | 200               | 1.15±0.10        | R                         |
| TMK316 SD473KF-T |               |                   |                             |  |  | 47000 p         | ±10                       | 0.1       | 200               | 1.15±0.10        | R                         |
| TMK316 SD563KF-T |               | 25                | Standard Type               |  |  | 56000 p         | ±10                       | 0.1       | 200               | 1.15±0.10        | R                         |
| TMK316 SD683KF-T |               |                   |                             |  |  | 68000 p         | ±10                       | 0.1       | 200               | 1.15±0.10        | R                         |

**Low Distortion High Value Multilayer Ceramic Capacitors(CF LD)**

● 107TYPE

[Temperature Characteristic LD : X5R] 0.8mm thickness(A)

| Part number 1     | Part number 2 | Rated voltage [V] | Temperature characteristics |  |  | Capacitance [F] | Capacitance tolerance [%] | tan δ [%] | HTLT              | Thickness*3 [mm] | Soldering R:Reflow W:Wave |
|-------------------|---------------|-------------------|-----------------------------|--|--|-----------------|---------------------------|-----------|-------------------|------------------|---------------------------|
|                   |               |                   |                             |  |  |                 |                           |           | Rated voltage x % |                  |                           |
| UMK107BLD224[A-T] |               | 50                | X5R                         |  |  | 0.22 μ          | ±10, ±20                  | 10        | 150               | 0.8+0.20/-0      | R                         |
| TMK107BLD474[A-T] |               | 25                | X5R                         |  |  | 0.47 μ          | ±10, ±20                  | 10        | 150               | 0.8+0.20/-0      | R                         |
| TMK107BLD105[A-T] |               |                   | X5R                         |  |  | 1 μ             | ±10, ±20                  | 10        | 150               | 0.8+0.20/-0      | R                         |

● 212TYPE

[Temperature Characteristic LD : X5R] 1.25mm thickness(G)

| Part number 1     | Part number 2 | Rated voltage [V] | Temperature characteristics |  |  | Capacitance [F] | Capacitance tolerance [%] | tan δ [%] | HTLT              | Thickness*3 [mm] | Soldering R:Reflow W:Wave |
|-------------------|---------------|-------------------|-----------------------------|--|--|-----------------|---------------------------|-----------|-------------------|------------------|---------------------------|
|                   |               |                   |                             |  |  |                 |                           |           | Rated voltage x % |                  |                           |
| GMK212 LD105[G-T] |               | 35                | X5R                         |  |  | 1 μ             | ±10, ±20                  | 10        | 150               | 1.25±0.10        | R                         |
| GMK212BLD225[G-T] |               |                   | X5R                         |  |  | 2.2 μ           | ±10, ±20                  | 10        | 150               | 1.25+0.20/-0     | R                         |

● 316TYPE

[Temperature Characteristic LD : X5R] 1.6mm thickness(L)

| Part number 1     | Part number 2 | Rated voltage [V] | Temperature characteristics |  |  | Capacitance [F] | Capacitance tolerance [%] | tan δ [%] | HTLT              | Thickness*3 [mm] | Soldering R:Reflow W:Wave |
|-------------------|---------------|-------------------|-----------------------------|--|--|-----------------|---------------------------|-----------|-------------------|------------------|---------------------------|
|                   |               |                   |                             |  |  |                 |                           |           | Rated voltage x % |                  |                           |
| UMK316 LD105[L-T] |               | 50                | X5R                         |  |  | 1 μ             | ±10, ±20                  | 10        | 150               | 1.6±0.20         | R                         |
| GMK316BLD475[L-T] |               | 35                | X5R                         |  |  | 4.7 μ           | ±10, ±20                  | 10        | 150               | 1.6±0.30         | R                         |
| TMK316BLD106[L-T] |               | 25                | X5R                         |  |  | 10 μ            | ±10, ±20                  | 10        | 150               | 1.6±0.30         | R                         |

● 325TYPE

[Temperature Characteristic LD : X5R] 1.9mm thickness(N)

| Part number 1     | Part number 2 | Rated voltage [V] | Temperature characteristics |  |  | Capacitance [F] | Capacitance tolerance [%] | tan δ [%] | HTLT              | Thickness*3 [mm] | Soldering R:Reflow W:Wave |
|-------------------|---------------|-------------------|-----------------------------|--|--|-----------------|---------------------------|-----------|-------------------|------------------|---------------------------|
|                   |               |                   |                             |  |  |                 |                           |           | Rated voltage x % |                  |                           |
| UMK325 LD105[N-T] |               | 50                | X5R                         |  |  | 1 μ             | ±10, ±20                  | 10        | 200               | 1.9±0.20         | R                         |

[Temperature Characteristic LD : X5R] 2.5mm thickness(M)

| Part number 1     | Part number 2 | Rated voltage [V] | Temperature characteristics |  |  | Capacitance [F] | Capacitance tolerance [%] | tan δ [%] | HTLT              | Thickness*3 [mm] | Soldering R:Reflow W:Wave |
|-------------------|---------------|-------------------|-----------------------------|--|--|-----------------|---------------------------|-----------|-------------------|------------------|---------------------------|
|                   |               |                   |                             |  |  |                 |                           |           | Rated voltage x % |                  |                           |
| UMK325 LD155[M-T] |               | 50                | X5R                         |  |  | 1.5 μ           | ±10, ±20                  | 5         | 150               | 2.5±0.20         | R                         |

**Medium-High Voltage Multilayer Ceramic Capacitors**

● 107TYPE

[Temperature Characteristic BJ : B/X5R] 0.8mm thickness(A)

| Part number 1     | Part number 2 | Rated voltage [V] | Temperature characteristics |                   |         | Capacitance [F] | Capacitance tolerance [%] | tan δ [%] | HTLT              | Thickness*3 [mm] | Soldering R:Reflow W:Wave |
|-------------------|---------------|-------------------|-----------------------------|-------------------|---------|-----------------|---------------------------|-----------|-------------------|------------------|---------------------------|
|                   |               |                   |                             |                   |         |                 |                           |           | Rated voltage x % |                  |                           |
| HMK107 BJ102[A-T] |               | 100               | B                           | X5R <sup>+1</sup> | 1000 p  | ±10, ±20        | 3.5                       | 200       | 0.8±0.10          | R                |                           |
| HMK107 BJ152[A-T] |               |                   | B                           | X5R <sup>+1</sup> | 1500 p  | ±10, ±20        | 3.5                       | 200       | 0.8±0.10          | R                |                           |
| HMK107 BJ222[A-T] |               |                   | B                           | X5R <sup>+1</sup> | 2200 p  | ±10, ±20        | 3.5                       | 200       | 0.8±0.10          | R                |                           |
| HMK107 BJ332[A-T] |               |                   | B                           | X5R <sup>+1</sup> | 3300 p  | ±10, ±20        | 3.5                       | 200       | 0.8±0.10          | R                |                           |
| HMK107 BJ472[A-T] |               |                   | B                           | X5R <sup>+1</sup> | 4700 p  | ±10, ±20        | 3.5                       | 200       | 0.8±0.10          | R                |                           |
| HMK107 BJ682[A-T] |               |                   | B                           | X5R <sup>+1</sup> | 6800 p  | ±10, ±20        | 3.5                       | 200       | 0.8±0.10          | R                |                           |
| HMK107 BJ103[A-T] |               |                   | B                           | X5R <sup>+1</sup> | 10000 p | ±10, ±20        | 3.5                       | 200       | 0.8±0.10          | R                |                           |
| HMK107 BJ153[A-T] |               |                   | B                           | X5R <sup>+1</sup> | 15000 p | ±10, ±20        | 3.5                       | 200       | 0.8±0.10          | R                |                           |
| HMK107 BJ223[A-T] |               |                   | B                           | X5R <sup>+1</sup> | 22000 p | ±10, ±20        | 3.5                       | 200       | 0.8±0.10          | R                |                           |
| HMK107 BJ333[A-T] |               |                   | B                           | X5R <sup>+1</sup> | 33000 p | ±10, ±20        | 3.5                       | 200       | 0.8±0.10          | R                |                           |
| HMK107 BJ473[A-T] |               |                   | B                           | X5R <sup>+1</sup> | 47000 p | ±10, ±20        | 3.5                       | 200       | 0.8±0.10          | R                |                           |
| HMK107 BJ104[A-T] |               |                   | B                           | X5R <sup>+1</sup> | 0.1 μ   | ±10, ±20        | 3.5                       | 200       | 0.8±0.10          | R                |                           |

[Temperature Characteristic B7 : X7R , C7 : X7S] 0.8mm thickness(A)

| Part number 1     | Part number 2 | Rated voltage [V] | Temperature characteristics |  |  | Capacitance [F] | Capacitance tolerance [%] | tan δ [%] | HTLT              | Thickness*3 [mm] | Soldering R:Reflow W:Wave |
|-------------------|---------------|-------------------|-----------------------------|--|--|-----------------|---------------------------|-----------|-------------------|------------------|---------------------------|
|                   |               |                   |                             |  |  |                 |                           |           | Rated voltage x % |                  |                           |
| HMK107 B7102[A-T] |               | 100               | X7R                         |  |  | 1000 p          | ±10, ±20                  | 3.5       | 200               | 0.8±0.10         | R                         |
| HMK107 B7152[A-T] |               |                   | X7R                         |  |  | 1500 p          | ±10, ±20                  | 3.5       | 200               | 0.8±0.10         | R                         |
| HMK107 B7222[A-T] |               |                   | X7R                         |  |  | 2200 p          | ±10, ±20                  | 3.5       | 200               | 0.8±0.10         | R                         |
| HMK107 B7332[A-T] |               |                   | X7R                         |  |  | 3300 p          | ±10, ±20                  | 3.5       | 200               | 0.8±0.10         | R                         |
| HMK107 B7472[A-T] |               |                   | X7R                         |  |  | 4700 p          | ±10, ±20                  | 3.5       | 200               | 0.8±0.10         | R                         |
| HMK107 B7682[A-T] |               |                   | X7R                         |  |  | 6800 p          | ±10, ±20                  | 3.5       | 200               | 0.8±0.10         | R                         |
| HMK107 B7103[A-T] |               |                   | X7R                         |  |  | 10000 p         | ±10, ±20                  | 3.5       | 200               | 0.8±0.10         | R                         |
| HMK107 B7153[A-T] |               |                   | X7R                         |  |  | 15000 p         | ±10, ±20                  | 3.5       | 200               | 0.8±0.10         | R                         |
| HMK107 B7223[A-T] |               |                   | X7R                         |  |  | 22000 p         | ±10, ±20                  | 3.5       | 200               | 0.8±0.10         | R                         |
| HMK107 B7333[A-T] |               |                   | X7R                         |  |  | 33000 p         | ±10, ±20                  | 3.5       | 200               | 0.8±0.10         | R                         |
| HMK107 B7473[A-T] |               |                   | X7R                         |  |  | 47000 p         | ±10, ±20                  | 3.5       | 200               | 0.8±0.10         | R                         |
| HMK107 C7104[A-T] |               |                   | X7S                         |  |  | 0.1 μ           | ±10, ±20                  | 3.5       | 200               | 0.8±0.10         | R                         |

▶ This catalog contains the typical specification only due to the limitation of space. When you consider the purchase of our products, please check our specification. For details of each product (characteristics graph, reliability information, precautions for use, and so on), see our Web site (<http://www.ty-top.com/>).

■ PARTS NUMBER

● 212TYPE

[Temperature Characteristic BJ : B/X5R] 1.25mm thickness (G)

| Part number 1    | Part number 2 | Rated voltage [V] | Temperature characteristics |                   | Capacitance [F] | Capacitance tolerance [%] | tan δ [%] | HTLT              | Thickness* <sup>3</sup> [mm] | Soldering R:Reflow W:Wave |
|------------------|---------------|-------------------|-----------------------------|-------------------|-----------------|---------------------------|-----------|-------------------|------------------------------|---------------------------|
|                  |               |                   |                             |                   |                 |                           |           | Rated voltage x % |                              |                           |
| HMK212 BJ103□G-T |               | 100               | B                           | X5R <sup>+1</sup> | 10000 p         | ±10, ±20                  | 3.5       | 200               | 1.25±0.10                    | R                         |
| HMK212 BJ153□G-T |               |                   | B                           | X5R <sup>+1</sup> | 15000 p         | ±10, ±20                  | 3.5       | 200               | 1.25±0.10                    | R                         |
| HMK212 BJ223□G-T |               |                   | B                           | X5R <sup>+1</sup> | 22000 p         | ±10, ±20                  | 3.5       | 200               | 1.25±0.10                    | R                         |
| HMK212 BJ333□G-T |               |                   | B                           | X5R <sup>+1</sup> | 33000 p         | ±10, ±20                  | 3.5       | 200               | 1.25±0.10                    | R                         |
| HMK212 BJ473□G-T |               |                   | B                           | X5R <sup>+1</sup> | 47000 p         | ±10, ±20                  | 3.5       | 200               | 1.25±0.10                    | R                         |
| HMK212 BJ683□G-T |               |                   | B                           | X5R <sup>+1</sup> | 68000 p         | ±10, ±20                  | 3.5       | 200               | 1.25±0.10                    | R                         |
| HMK212 BJ104□G-T |               |                   | B                           | X5R <sup>+1</sup> | 0.1 μ           | ±10, ±20                  | 3.5       | 200               | 1.25±0.10                    | R                         |
| HMK212 BJ224□G-T |               |                   | B                           | X5R <sup>+1</sup> | 0.22 μ          | ±10, ±20                  | 3.5       | 200               | 1.25±0.10                    | R                         |
| QMK212 BJ472□G-T |               |                   | B                           | X5R <sup>+1</sup> | 4700 p          | ±10, ±20                  | 2.5       | 150               | 1.25±0.10                    | R                         |
| QMK212 BJ682□G-T |               |                   | B                           | X5R <sup>+1</sup> | 6800 p          | ±10, ±20                  | 2.5       | 150               | 1.25±0.10                    | R                         |
| QMK212 BJ103□G-T |               | 250               | B                           | X5R <sup>+1</sup> | 10000 p         | ±10, ±20                  | 2.5       | 150               | 1.25±0.10                    | R                         |
| QMK212 BJ153□G-T |               |                   | B                           | X5R <sup>+1</sup> | 15000 p         | ±10, ±20                  | 2.5       | 150               | 1.25±0.10                    | R                         |
| QMK212 BJ223□G-T |               |                   | B                           | X5R <sup>+1</sup> | 22000 p         | ±10, ±20                  | 2.5       | 150               | 1.25±0.10                    | R                         |
| QMK212 BJ332□G-T |               |                   | B                           | X5R <sup>+1</sup> | 33000 p         | ±10, ±20                  | 2.5       | 150               | 1.25±0.10                    | R                         |

[Temperature Characteristic BJ : B/X5R] 0.85mm thickness (D)

| Part number 1    | Part number 2 | Rated voltage [V] | Temperature characteristics |                   | Capacitance [F] | Capacitance tolerance [%] | tan δ [%] | HTLT              | Thickness* <sup>3</sup> [mm] | Soldering R:Reflow W:Wave |
|------------------|---------------|-------------------|-----------------------------|-------------------|-----------------|---------------------------|-----------|-------------------|------------------------------|---------------------------|
|                  |               |                   |                             |                   |                 |                           |           | Rated voltage x % |                              |                           |
| QMK212 BJ102□D-T |               | 250               | B                           | X5R <sup>+1</sup> | 1000 p          | ±10, ±20                  | 2.5       | 150               | 0.85±0.10                    | R                         |
| QMK212 BJ152□D-T |               |                   | B                           | X5R <sup>+1</sup> | 1500 p          | ±10, ±20                  | 2.5       | 150               | 0.85±0.10                    | R                         |
| QMK212 BJ222□D-T |               |                   | B                           | X5R <sup>+1</sup> | 2200 p          | ±10, ±20                  | 2.5       | 150               | 0.85±0.10                    | R                         |
| QMK212 BJ332□D-T |               |                   | B                           | X5R <sup>+1</sup> | 3300 p          | ±10, ±20                  | 2.5       | 150               | 0.85±0.10                    | R                         |

[Temperature Characteristic B7 : X7R] 1.25mm thickness (G)

| Part number 1    | Part number 2 | Rated voltage [V] | Temperature characteristics |         | Capacitance [F] | Capacitance tolerance [%] | tan δ [%] | HTLT              | Thickness* <sup>3</sup> [mm] | Soldering R:Reflow W:Wave |   |
|------------------|---------------|-------------------|-----------------------------|---------|-----------------|---------------------------|-----------|-------------------|------------------------------|---------------------------|---|
|                  |               |                   |                             |         |                 |                           |           | Rated voltage x % |                              |                           |   |
| HMK212 B7103□G-T |               | 100               |                             | X7R     | 10000 p         | ±10, ±20                  | 3.5       | 200               | 1.25±0.10                    | R                         |   |
| HMK212 B7153□G-T |               |                   |                             | X7R     | 15000 p         | ±10, ±20                  | 3.5       | 200               | 1.25±0.10                    | R                         |   |
| HMK212 B7223□G-T |               |                   |                             | X7R     | 22000 p         | ±10, ±20                  | 3.5       | 200               | 1.25±0.10                    | R                         |   |
| HMK212 B7333□G-T |               |                   |                             | X7R     | 33000 p         | ±10, ±20                  | 3.5       | 200               | 1.25±0.10                    | R                         |   |
| HMK212 B7473□G-T |               |                   |                             | X7R     | 47000 p         | ±10, ±20                  | 3.5       | 200               | 1.25±0.10                    | R                         |   |
| HMK212 B7683□G-T |               |                   |                             | X7R     | 68000 p         | ±10, ±20                  | 3.5       | 200               | 1.25±0.10                    | R                         |   |
| HMK212 B7104□G-T |               |                   |                             | X7R     | 0.1 μ           | ±10, ±20                  | 3.5       | 200               | 1.25±0.10                    | R                         |   |
| HMK212 B7224□G-T |               |                   |                             | X7R     | 0.22 μ          | ±10, ±20                  | 3.5       | 200               | 1.25±0.10                    | R                         |   |
| QMK212 B7472□G-T |               |                   | 250                         |         | X7R             | 4700 p                    | ±10, ±20  | 2.5               | 150                          | 1.25±0.10                 | R |
| QMK212 B7682□G-T |               |                   |                             |         | X7R             | 6800 p                    | ±10, ±20  | 2.5               | 150                          | 1.25±0.10                 | R |
| QMK212 B7103□G-T |               |                   |                             | X7R     | 10000 p         | ±10, ±20                  | 2.5       | 150               | 1.25±0.10                    | R                         |   |
| QMK212 B7153□G-T |               |                   |                             | X7R     | 15000 p         | ±10, ±20                  | 2.5       | 150               | 1.25±0.10                    | R                         |   |
| QMK212 B7223□G-T |               |                   | X7R                         | 22000 p | ±10, ±20        | 2.5                       | 150       | 1.25±0.10         | R                            |                           |   |

[Temperature Characteristic B7 : X7R] 0.85mm thickness (D)

| Part number 1    | Part number 2 | Rated voltage [V] | Temperature characteristics |     | Capacitance [F] | Capacitance tolerance [%] | tan δ [%] | HTLT              | Thickness* <sup>3</sup> [mm] | Soldering R:Reflow W:Wave |
|------------------|---------------|-------------------|-----------------------------|-----|-----------------|---------------------------|-----------|-------------------|------------------------------|---------------------------|
|                  |               |                   |                             |     |                 |                           |           | Rated voltage x % |                              |                           |
| QMK212 B7102□D-T |               | 250               |                             | X7R | 1000 p          | ±10, ±20                  | 2.5       | 150               | 0.85±0.10                    | R                         |
| QMK212 B7152□D-T |               |                   |                             | X7R | 1500 p          | ±10, ±20                  | 2.5       | 150               | 0.85±0.10                    | R                         |
| QMK212 B7222□D-T |               |                   |                             | X7R | 2200 p          | ±10, ±20                  | 2.5       | 150               | 0.85±0.10                    | R                         |
| QMK212 B7332□D-T |               |                   |                             | X7R | 3300 p          | ±10, ±20                  | 2.5       | 150               | 0.85±0.10                    | R                         |

● 316TYPE

[Temperature Characteristic BJ : B/X5R] 1.6mm thickness (L)

| Part number 1    | Part number 2 | Rated voltage [V] | Temperature characteristics |                   | Capacitance [F]   | Capacitance tolerance [%] | tan δ [%] | HTLT              | Thickness* <sup>3</sup> [mm] | Soldering R:Reflow W:Wave |   |
|------------------|---------------|-------------------|-----------------------------|-------------------|-------------------|---------------------------|-----------|-------------------|------------------------------|---------------------------|---|
|                  |               |                   |                             |                   |                   |                           |           | Rated voltage x % |                              |                           |   |
| HMK316 BJ473□L-T |               | 100               | B                           | X5R <sup>+1</sup> | 47000 p           | ±10, ±20                  | 3.5       | 200               | 1.6±0.20                     | R                         |   |
| HMK316 BJ683□L-T |               |                   | B                           | X5R <sup>+1</sup> | 68000 p           | ±10, ±20                  | 3.5       | 200               | 1.6±0.20                     | R                         |   |
| HMK316 BJ104□L-T |               |                   | B                           | X5R <sup>+1</sup> | 0.1 μ             | ±10, ±20                  | 3.5       | 200               | 1.6±0.20                     | R                         |   |
| HMK316 BJ154□L-T |               |                   | B                           | X5R <sup>+1</sup> | 0.15 μ            | ±10, ±20                  | 3.5       | 200               | 1.6±0.20                     | R                         |   |
| HMK316 BJ224□L-T |               |                   | B                           | X5R <sup>+1</sup> | 0.22 μ            | ±10, ±20                  | 3.5       | 200               | 1.6±0.20                     | R                         |   |
| HMK316 BJ334□L-T |               |                   | B                           | X5R <sup>+1</sup> | 0.33 μ            | ±10, ±20                  | 3.5       | 200               | 1.6±0.20                     | R                         |   |
| HMK316 BJ474□L-T |               |                   | B                           | X5R <sup>+1</sup> | 0.47 μ            | ±10, ±20                  | 3.5       | 200               | 1.6±0.20                     | R                         |   |
| HMK316 BJ105□L-T |               |                   | B                           | X5R <sup>+1</sup> | 1 μ               | ±10, ±20                  | 3.5       | 200               | 1.6±0.20                     | R                         |   |
| QMK316 BJ333□L-T |               |                   | 250                         | B                 | X5R <sup>+1</sup> | 33000 p                   | ±10, ±20  | 2.5               | 150                          | 1.6±0.20                  | R |
| QMK316 BJ473□L-T |               |                   |                             | B                 | X5R <sup>+1</sup> | 47000 p                   | ±10, ±20  | 2.5               | 150                          | 1.6±0.20                  | R |
| QMK316 BJ683□L-T |               | B                 |                             | X5R <sup>+1</sup> | 68000 p           | ±10, ±20                  | 2.5       | 150               | 1.6±0.20                     | R                         |   |
| QMK316 BJ104□L-T |               | B                 |                             | X5R <sup>+1</sup> | 0.1 μ             | ±10, ±20                  | 2.5       | 150               | 1.6±0.20                     | R                         |   |
| SMK316 BJ153□L-T |               | 630               | B                           | X5R <sup>+1</sup> | 15000 p           | ±10, ±20                  | 2.5       | 120               | 1.6±0.20                     | R                         |   |
| SMK316 BJ223□L-T |               |                   | B                           | X5R <sup>+1</sup> | 22000 p           | ±10, ±20                  | 2.5       | 120               | 1.6±0.20                     | R                         |   |

[Temperature Characteristic BJ : B/X5R] 1.15mm thickness (F)

| Part number 1    | Part number 2 | Rated voltage [V] | Temperature characteristics |                   | Capacitance [F] | Capacitance tolerance [%] | tan δ [%] | HTLT              | Thickness* <sup>3</sup> [mm] | Soldering R:Reflow W:Wave |
|------------------|---------------|-------------------|-----------------------------|-------------------|-----------------|---------------------------|-----------|-------------------|------------------------------|---------------------------|
|                  |               |                   |                             |                   |                 |                           |           | Rated voltage x % |                              |                           |
| SMK316 BJ102□F-T |               | 630               | B                           | X5R <sup>+1</sup> | 1000 p          | ±10, ±20                  | 2.5       | 120               | 1.15±0.10                    | R                         |
| SMK316 BJ152□F-T |               |                   | B                           | X5R <sup>+1</sup> | 1500 p          | ±10, ±20                  | 2.5       | 120               | 1.15±0.10                    | R                         |
| SMK316 BJ222□F-T |               |                   | B                           | X5R <sup>+1</sup> | 2200 p          | ±10, ±20                  | 2.5       | 120               | 1.15±0.10                    | R                         |
| SMK316 BJ332□F-T |               |                   | B                           | X5R <sup>+1</sup> | 3300 p          | ±10, ±20                  | 2.5       | 120               | 1.15±0.10                    | R                         |
| SMK316 BJ472□F-T |               |                   | B                           | X5R <sup>+1</sup> | 4700 p          | ±10, ±20                  | 2.5       | 120               | 1.15±0.10                    | R                         |
| SMK316 BJ682□F-T |               |                   | B                           | X5R <sup>+1</sup> | 6800 p          | ±10, ±20                  | 2.5       | 120               | 1.15±0.10                    | R                         |
| SMK316 BJ103□F-T |               |                   | B                           | X5R <sup>+1</sup> | 10000 p         | ±10, ±20                  | 2.5       | 120               | 1.15±0.10                    | R                         |

▶ This catalog contains the typical specification only due to the limitation of space. When you consider the purchase of our products, please check our specification. For details of each product (characteristics graph, reliability information, precautions for use, and so on), see our Web site (<http://www.ty-top.com/>).

【Temperature Characteristic B7 : X7R】 1.6mm thickness (L)

| Part number 1    | Part number 2 | Rated voltage [V] | Temperature characteristics | Capacitance [F] | Capacitance tolerance [%] | tan δ [%] | HTLT              |     | Thickness* <sup>3</sup> [mm] | Soldering R:Reflow W:Wave |   |
|------------------|---------------|-------------------|-----------------------------|-----------------|---------------------------|-----------|-------------------|-----|------------------------------|---------------------------|---|
|                  |               |                   |                             |                 |                           |           | Rated voltage x % |     |                              |                           |   |
| HMK316 B7473□L-T |               | 100               | X7R                         | 47000 p         | ±10, ±20                  | 3.5       | 200               |     | 1.6±0.20                     | R                         |   |
| HMK316 B7683□L-T |               |                   | X7R                         | 68000 p         | ±10, ±20                  | 3.5       | 200               |     | 1.6±0.20                     | R                         |   |
| HMK316 B7104□L-T |               |                   | X7R                         | 0.1 μ           | ±10, ±20                  | 3.5       | 200               |     | 1.6±0.20                     | R                         |   |
| HMK316 B7154□L-T |               |                   | X7R                         | 0.15 μ          | ±10, ±20                  | 3.5       | 200               |     | 1.6±0.20                     | R                         |   |
| HMK316 B7224□L-T |               |                   | X7R                         | 0.22 μ          | ±10, ±20                  | 3.5       | 200               |     | 1.6±0.20                     | R                         |   |
| HMK316 B7334□L-T |               |                   | X7R                         | 0.33 μ          | ±10, ±20                  | 3.5       | 200               |     | 1.6±0.20                     | R                         |   |
| HMK316 B7474□L-T |               |                   | X7R                         | 0.47 μ          | ±10, ±20                  | 3.5       | 200               |     | 1.6±0.20                     | R                         |   |
| HMK316 B7105□L-T |               |                   | X7R                         | 1 μ             | ±10, ±20                  | 3.5       | 200               |     | 1.6±0.20                     | R                         |   |
| QMK316 B7333□L-T |               |                   | 250                         | X7R             | 33000 p                   | ±10, ±20  | 2.5               | 150 |                              | 1.6±0.20                  | R |
| QMK316 B7473□L-T |               |                   |                             | X7R             | 47000 p                   | ±10, ±20  | 2.5               | 150 |                              | 1.6±0.20                  | R |
| QMK316 B7683□L-T |               | X7R               |                             | 68000 p         | ±10, ±20                  | 2.5       | 150               |     | 1.6±0.20                     | R                         |   |
| QMK316 B7104□L-T |               | X7R               |                             | 0.1 μ           | ±10, ±20                  | 2.5       | 150               |     | 1.6±0.20                     | R                         |   |
| SMK316 B7153□L-T |               | 630               | X7R                         | 15000 p         | ±10, ±20                  | 2.5       | 120               |     | 1.6±0.20                     | R                         |   |
| SMK316 B7223□L-T |               |                   | X7R                         | 22000 p         | ±10, ±20                  | 2.5       | 120               |     | 1.6±0.20                     | R                         |   |

【Temperature Characteristic B7 : X7R】 1.15mm thickness (F)

| Part number 1    | Part number 2 | Rated voltage [V] | Temperature characteristics | Capacitance [F] | Capacitance tolerance [%] | tan δ [%] | HTLT              |  | Thickness* <sup>3</sup> [mm] | Soldering R:Reflow W:Wave |
|------------------|---------------|-------------------|-----------------------------|-----------------|---------------------------|-----------|-------------------|--|------------------------------|---------------------------|
|                  |               |                   |                             |                 |                           |           | Rated voltage x % |  |                              |                           |
| SMK316 B7102□F-T |               | 630               | X7R                         | 1000 p          | ±10, ±20                  | 2.5       | 120               |  | 1.15±0.10                    | R                         |
| SMK316 B7152□F-T |               |                   | X7R                         | 1500 p          | ±10, ±20                  | 2.5       | 120               |  | 1.15±0.10                    | R                         |
| SMK316 B7222□F-T |               |                   | X7R                         | 2200 p          | ±10, ±20                  | 2.5       | 120               |  | 1.15±0.10                    | R                         |
| SMK316 B7332□F-T |               |                   | X7R                         | 3300 p          | ±10, ±20                  | 2.5       | 120               |  | 1.15±0.10                    | R                         |
| SMK316 B7472□F-T |               |                   | X7R                         | 4700 p          | ±10, ±20                  | 2.5       | 120               |  | 1.15±0.10                    | R                         |
| SMK316 B7682□F-T |               |                   | X7R                         | 6800 p          | ±10, ±20                  | 2.5       | 120               |  | 1.15±0.10                    | R                         |
| SMK316 B7103□F-T |               |                   | X7R                         | 10000 p         | ±10, ±20                  | 2.5       | 120               |  | 1.15±0.10                    | R                         |

## ● 325TYPE

【Temperature Characteristic BJ : B/X5R】 2.5mm thickness (M)

| Part number 1    | Part number 2 | Rated voltage [V] | Temperature characteristics | Capacitance [F] | Capacitance tolerance [%] | tan δ [%] | HTLT              |  | Thickness* <sup>3</sup> [mm] | Soldering R:Reflow W:Wave |
|------------------|---------------|-------------------|-----------------------------|-----------------|---------------------------|-----------|-------------------|--|------------------------------|---------------------------|
|                  |               |                   |                             |                 |                           |           | Rated voltage x % |  |                              |                           |
| HMK325 BJ225□M-T |               | 100               | B X5R <sup>*1</sup>         | 2.2 μ           | ±10, ±20                  | 3.5       | 200               |  | 2.5±0.20                     | R                         |

【Temperature Characteristic BJ : B/X5R】 1.9mm thickness (N)

| Part number 1    | Part number 2 | Rated voltage [V] | Temperature characteristics | Capacitance [F]     | Capacitance tolerance [%] | tan δ [%] | HTLT              |     | Thickness* <sup>3</sup> [mm] | Soldering R:Reflow W:Wave |   |
|------------------|---------------|-------------------|-----------------------------|---------------------|---------------------------|-----------|-------------------|-----|------------------------------|---------------------------|---|
|                  |               |                   |                             |                     |                           |           | Rated voltage x % |     |                              |                           |   |
| HMK325 BJ154□N-T |               | 100               | B X5R <sup>*1</sup>         | 0.15 μ              | ±10, ±20                  | 3.5       | 200               |     | 1.9±0.20                     | R                         |   |
| HMK325 BJ224□N-T |               |                   | B X5R <sup>*1</sup>         | 0.22 μ              | ±10, ±20                  | 3.5       | 200               |     | 1.9±0.20                     | R                         |   |
| HMK325 BJ334□N-T |               |                   | B X5R <sup>*1</sup>         | 0.33 μ              | ±10, ±20                  | 3.5       | 200               |     | 1.9±0.20                     | R                         |   |
| HMK325 BJ474□N-T |               |                   | B X5R <sup>*1</sup>         | 0.47 μ              | ±10, ±20                  | 3.5       | 200               |     | 1.9±0.20                     | R                         |   |
| HMK325 BJ684□N-T |               |                   | B X5R <sup>*1</sup>         | 0.68 μ              | ±10, ±20                  | 3.5       | 200               |     | 1.9±0.20                     | R                         |   |
| HMK325 BJ105□N-T |               |                   | B X5R <sup>*1</sup>         | 1 μ                 | ±10, ±20                  | 3.5       | 200               |     | 1.9±0.20                     | R                         |   |
| QMK325 BJ473□N-T |               |                   | 250                         | B X5R <sup>*1</sup> | 47000 p                   | ±10, ±20  | 2.5               | 150 |                              | 1.9±0.20                  | R |
| QMK325 BJ104□N-T |               |                   |                             | B X5R <sup>*1</sup> | 0.1 μ                     | ±10, ±20  | 2.5               | 150 |                              | 1.9±0.20                  | R |
| QMK325 BJ154□N-T |               |                   |                             | B X5R <sup>*1</sup> | 0.15 μ                    | ±10, ±20  | 2.5               | 150 |                              | 1.9±0.20                  | R |
| QMK325 BJ224□N-T |               |                   |                             | B X5R <sup>*1</sup> | 0.22 μ                    | ±10, ±20  | 2.5               | 150 |                              | 1.9±0.20                  | R |
| SMK325 BJ223□N-T |               | 630               | B X5R <sup>*1</sup>         | 22000 p             | ±10, ±20                  | 2.5       | 120               |     | 1.9±0.20                     | R                         |   |
| SMK325 BJ333□N-T |               |                   | B X5R <sup>*1</sup>         | 33000 p             | ±10, ±20                  | 2.5       | 120               |     | 1.9±0.20                     | R                         |   |
| SMK325 BJ473□N-T |               |                   | B X5R <sup>*1</sup>         | 47000 p             | ±10, ±20                  | 2.5       | 120               |     | 1.9±0.20                     | R                         |   |

【Temperature Characteristic BJ : B/X5R】 1.15mm thickness (F)

| Part number 1    | Part number 2 | Rated voltage [V] | Temperature characteristics | Capacitance [F] | Capacitance tolerance [%] | tan δ [%] | HTLT              |  | Thickness* <sup>3</sup> [mm] | Soldering R:Reflow W:Wave |
|------------------|---------------|-------------------|-----------------------------|-----------------|---------------------------|-----------|-------------------|--|------------------------------|---------------------------|
|                  |               |                   |                             |                 |                           |           | Rated voltage x % |  |                              |                           |
| HMK325 BJ104□F-T |               | 100               | B X5R <sup>*1</sup>         | 0.1 μ           | ±10, ±20                  | 3.5       | 200               |  | 1.15±0.10                    | R                         |

【Temperature Characteristic B7 : X7R】 2.5mm thickness (M)

| Part number 1    | Part number 2 | Rated voltage [V] | Temperature characteristics | Capacitance [F] | Capacitance tolerance [%] | tan δ [%] | HTLT              |  | Thickness* <sup>3</sup> [mm] | Soldering R:Reflow W:Wave |
|------------------|---------------|-------------------|-----------------------------|-----------------|---------------------------|-----------|-------------------|--|------------------------------|---------------------------|
|                  |               |                   |                             |                 |                           |           | Rated voltage x % |  |                              |                           |
| HMK325 B7225□M-T |               | 100               | X7R                         | 2.2 μ           | ±10, ±20                  | 3.5       | 200               |  | 2.5±0.20                     | R                         |

【Temperature Characteristic B7 : X7R】 1.9mm thickness (N)

| Part number 1    | Part number 2 | Rated voltage [V] | Temperature characteristics | Capacitance [F] | Capacitance tolerance [%] | tan δ [%] | HTLT              |     | Thickness* <sup>3</sup> [mm] | Soldering R:Reflow W:Wave |   |
|------------------|---------------|-------------------|-----------------------------|-----------------|---------------------------|-----------|-------------------|-----|------------------------------|---------------------------|---|
|                  |               |                   |                             |                 |                           |           | Rated voltage x % |     |                              |                           |   |
| HMK325 B7154□N-T |               | 100               | X7R                         | 0.15 μ          | ±10, ±20                  | 3.5       | 200               |     | 1.9±0.20                     | R                         |   |
| HMK325 B7224□N-T |               |                   | X7R                         | 0.22 μ          | ±10, ±20                  | 3.5       | 200               |     | 1.9±0.20                     | R                         |   |
| HMK325 B7334□N-T |               |                   | X7R                         | 0.33 μ          | ±10, ±20                  | 3.5       | 200               |     | 1.9±0.20                     | R                         |   |
| HMK325 B7474□N-T |               |                   | X7R                         | 0.47 μ          | ±10, ±20                  | 3.5       | 200               |     | 1.9±0.20                     | R                         |   |
| HMK325 B7684□N-T |               |                   | X7R                         | 0.68 μ          | ±10, ±20                  | 3.5       | 200               |     | 1.9±0.20                     | R                         |   |
| HMK325 B7105□N-T |               |                   | X7R                         | 1 μ             | ±10, ±20                  | 3.5       | 200               |     | 1.9±0.20                     | R                         |   |
| QMK325 B7473□N-T |               |                   | 250                         | X7R             | 47000 p                   | ±10, ±20  | 2.5               | 150 |                              | 1.9±0.20                  | R |
| QMK325 B7104□N-T |               |                   |                             | X7R             | 0.1 μ                     | ±10, ±20  | 2.5               | 150 |                              | 1.9±0.20                  | R |
| QMK325 B7154□N-T |               |                   |                             | X7R             | 0.15 μ                    | ±10, ±20  | 2.5               | 150 |                              | 1.9±0.20                  | R |
| QMK325 B7224□N-T |               |                   |                             | X7R             | 0.22 μ                    | ±10, ±20  | 2.5               | 150 |                              | 1.9±0.20                  | R |
| SMK325 B7223□N-T |               | 630               | X7R                         | 22000 p         | ±10, ±20                  | 2.5       | 120               |     | 1.9±0.20                     | R                         |   |
| SMK325 B7333□N-T |               |                   | X7R                         | 33000 p         | ±10, ±20                  | 2.5       | 120               |     | 1.9±0.20                     | R                         |   |
| SMK325 B7473□N-T |               |                   | X7R                         | 47000 p         | ±10, ±20                  | 2.5       | 120               |     | 1.9±0.20                     | R                         |   |

【Temperature Characteristic B7 : X7R】 1.15mm thickness (F)

| Part number 1    | Part number 2 | Rated voltage [V] | Temperature characteristics | Capacitance [F] | Capacitance tolerance [%] | tan δ [%] | HTLT              |  | Thickness* <sup>3</sup> [mm] | Soldering R:Reflow W:Wave |
|------------------|---------------|-------------------|-----------------------------|-----------------|---------------------------|-----------|-------------------|--|------------------------------|---------------------------|
|                  |               |                   |                             |                 |                           |           | Rated voltage x % |  |                              |                           |
| HMK325 B7104□F-T |               | 100               | X7R                         | 0.1 μ           | ±10, ±20                  | 3.5       | 200               |  | 1.15±0.10                    | R                         |

▶ This catalog contains the typical specification only due to the limitation of space. When you consider the purchase of our products, please check our specification. For details of each product (characteristics graph, reliability information, precautions for use, and so on), see our Web site (<http://www.ty-top.com/>).

## ● 432TYPE

[Temperature Characteristic BJ : B/X5R] 2.5mm thickness(M)

| Part number 1    | Part number 2 | Rated voltage [V] | Temperature characteristics |                  | Capacitance [F] | Capacitance tolerance [%] | tan δ [%] | HTLT              | Thickness* <sup>3</sup> [mm] | Soldering R:Reflow W:Wave |
|------------------|---------------|-------------------|-----------------------------|------------------|-----------------|---------------------------|-----------|-------------------|------------------------------|---------------------------|
|                  |               |                   |                             |                  |                 |                           |           | Rated voltage x % |                              |                           |
| HMK432 BJ474□M-T |               | 100               | B                           | X5R <sup>+</sup> | 0.47 μ          | ±10, ±20                  | 3.5       | 200               | 2.5±0.20                     | R                         |
| HMK432 BJ105□M-T |               |                   | B                           | X5R <sup>+</sup> | 1 μ             | ±10, ±20                  | 3.5       | 200               | 2.5±0.20                     | R                         |
| HMK432 BJ155□M-T |               |                   | B                           | X5R <sup>+</sup> | 1.5 μ           | ±10, ±20                  | 3.5       | 200               | 2.5±0.20                     | R                         |
| HMK432 BJ225□M-T |               | 250               | B                           | X5R <sup>+</sup> | 2.2 μ           | ±10, ±20                  | 3.5       | 200               | 2.5±0.20                     | R                         |
| QMK432 BJ104□M-T |               |                   | B                           | X5R <sup>+</sup> | 0.1 μ           | ±10, ±20                  | 2.5       | 150               | 2.5±0.20                     | R                         |
| QMK432 BJ224□M-T |               |                   | B                           | X5R <sup>+</sup> | 0.22 μ          | ±10, ±20                  | 2.5       | 150               | 2.5±0.20                     | R                         |
| QMK432 BJ334□M-T |               | 630               | B                           | X5R <sup>+</sup> | 0.33 μ          | ±10, ±20                  | 2.5       | 150               | 2.5±0.20                     | R                         |
| QMK432 BJ474□M-T |               |                   | B                           | X5R <sup>+</sup> | 0.47 μ          | ±10, ±20                  | 2.5       | 150               | 2.5±0.20                     | R                         |
| SMK432 BJ473□M-T |               |                   | B                           | X5R <sup>+</sup> | 47000 p         | ±10, ±20                  | 2.5       | 120               | 2.5±0.20                     | R                         |
| SMK432 BJ683□M-T |               | 630               | B                           | X5R <sup>+</sup> | 68000 p         | ±10, ±20                  | 2.5       | 120               | 2.5±0.20                     | R                         |
| SMK432 BJ104□M-T |               |                   | B                           | X5R <sup>+</sup> | 0.1 μ           | ±10, ±20                  | 2.5       | 120               | 2.5±0.20                     | R                         |

[Temperature Characteristic B7 : X7R] 2.5mm thickness(M)

| Part number 1    | Part number 2 | Rated voltage [V] | Temperature characteristics |     | Capacitance [F] | Capacitance tolerance [%] | tan δ [%] | HTLT              | Thickness* <sup>3</sup> [mm] | Soldering R:Reflow W:Wave |
|------------------|---------------|-------------------|-----------------------------|-----|-----------------|---------------------------|-----------|-------------------|------------------------------|---------------------------|
|                  |               |                   |                             |     |                 |                           |           | Rated voltage x % |                              |                           |
| HMK432 B7474□M-T |               | 100               |                             | X7R | 0.47 μ          | ±10, ±20                  | 3.5       | 200               | 2.5±0.20                     | R                         |
| HMK432 B7105□M-T |               |                   |                             | X7R | 1 μ             | ±10, ±20                  | 3.5       | 200               | 2.5±0.20                     | R                         |
| HMK432 B7155□M-T |               |                   |                             | X7R | 1.5 μ           | ±10, ±20                  | 3.5       | 200               | 2.5±0.20                     | R                         |
| HMK432 B7225□M-T |               | 250               |                             | X7R | 2.2 μ           | ±10, ±20                  | 3.5       | 200               | 2.5±0.20                     | R                         |
| QMK432 B7104□M-T |               |                   |                             | X7R | 0.1 μ           | ±10, ±20                  | 2.5       | 150               | 2.5±0.20                     | R                         |
| QMK432 B7224□M-T |               |                   |                             | X7R | 0.22 μ          | ±10, ±20                  | 2.5       | 150               | 2.5±0.20                     | R                         |
| QMK432 B7334□M-T |               | 630               |                             | X7R | 0.33 μ          | ±10, ±20                  | 2.5       | 150               | 2.5±0.20                     | R                         |
| QMK432 B7474□M-T |               |                   |                             | X7R | 0.47 μ          | ±10, ±20                  | 2.5       | 150               | 2.5±0.20                     | R                         |
| SMK432 B7473□M-T |               |                   |                             | X7R | 47000 p         | ±10, ±20                  | 2.5       | 120               | 2.5±0.20                     | R                         |
| SMK432 B7683□M-T |               | 630               |                             | X7R | 68000 p         | ±10, ±20                  | 2.5       | 120               | 2.5±0.20                     | R                         |
| SMK432 B7104□M-T |               |                   |                             | X7R | 0.1 μ           | ±10, ±20                  | 2.5       | 120               | 2.5±0.20                     | R                         |

## LW Reversal Decoupling Capacitors (LWDG™)

## ● 105TYPE

[Temperature Characteristic BJ : X5R] 0.3mm thickness(P)

| Part number 1    | Part number 2 | Rated voltage [V] | Temperature characteristics |                  | Capacitance [F] | Capacitance tolerance [%] | tan δ [%] | HTLT              | Thickness* <sup>3</sup> [mm] | Soldering R:Reflow W:Wave |
|------------------|---------------|-------------------|-----------------------------|------------------|-----------------|---------------------------|-----------|-------------------|------------------------------|---------------------------|
|                  |               |                   |                             |                  |                 |                           |           | Rated voltage x % |                              |                           |
| TWK105 BJ104MP-F |               | 25                |                             | X5R              | 0.1 μ           | ±20                       | 5         | 150               | 0.3±0.05                     | R                         |
| EWK105 BJ224MP-F |               | 16                |                             | X5R              | 0.22 μ          | ±20                       | 10        | 150               | 0.3±0.05                     | R                         |
| LWK105 BJ474MP-F |               | 10                |                             | X5R              | 0.47 μ          | ±20                       | 10        | 150               | 0.3±0.05                     | R                         |
| JWK105 BJ104MP-F |               | 6.3               |                             | X5R <sup>+</sup> | 0.1 μ           | ±20                       | 5         | 150               | 0.3±0.05                     | R                         |
| JWK105 BJ474MP-F |               |                   |                             | X5R <sup>+</sup> | 0.47 μ          | ±20                       | 10        | 150               | 0.3±0.05                     | R                         |
| JWK105 BJ105MP-F |               |                   |                             | X5R              | 1 μ             | ±20                       | 10        | 150               | 0.3±0.05                     | R                         |
| JWK105 BJ225MP-F |               | 4                 |                             | X5R              | 2.2 μ           | ±20                       | 10        | 150               | 0.3±0.05                     | R                         |
| AWK105 BJ224MP-F |               |                   |                             | X5R              | 0.22 μ          | ±20                       | 10        | 150               | 0.3±0.05                     | R                         |

[Temperature Characteristic C6 : X6S, C7 : X7S] 0.3mm thickness(P)

| Part number 1    | Part number 2 | Rated voltage [V] | Temperature characteristics |     | Capacitance [F] | Capacitance tolerance [%] | tan δ [%] | HTLT              | Thickness* <sup>3</sup> [mm] | Soldering R:Reflow W:Wave |
|------------------|---------------|-------------------|-----------------------------|-----|-----------------|---------------------------|-----------|-------------------|------------------------------|---------------------------|
|                  |               |                   |                             |     |                 |                           |           | Rated voltage x % |                              |                           |
| EWK105 C6104MP-F |               | 16                |                             | X6S | 0.1 μ           | ±20                       | 5         | 150               | 0.3±0.05                     | R                         |
| LWK105 C7104MP-F |               | 10                |                             | X7S | 0.1 μ           | ±20                       | 5         | 150               | 0.3±0.05                     | R                         |
| LWK105 C6224MP-F |               |                   |                             | X6S | 0.22 μ          | ±20                       | 10        | 150               | 0.3±0.05                     | R                         |
| JWK105 C7104MP-F |               | 6.3               |                             | X7S | 0.1 μ           | ±20                       | 5         | 150               | 0.3±0.05                     | R                         |
| JWK105 C7224MP-F |               |                   |                             | X7S | 0.22 μ          | ±20                       | 10        | 150               | 0.3±0.05                     | R                         |
| JWK105 C6474MP-F |               |                   |                             | X6S | 0.47 μ          | ±20                       | 10        | 150               | 0.3±0.05                     | R                         |
| AWK105 C6224MP-F |               | 4                 |                             | X6S | 0.22 μ          | ±20                       | 10        | 150               | 0.3±0.05                     | R                         |
| AWK105 C6474MP-F |               |                   |                             | X6S | 0.47 μ          | ±20                       | 10        | 150               | 0.3±0.05                     | R                         |
| AWK105 C6105MP-F |               |                   |                             | X6S | 1 μ             | ±20                       | 10        | 150               | 0.3±0.05                     | R                         |
| AWK105 C6225MP-F |               |                   |                             | X6S | 2.2 μ           | ±20                       | 10        | 150               | 0.3±0.05                     | R                         |

## ● 107TYPE

[Temperature Characteristic BJ : X5R] 0.5mm thickness(V)

| Part number 1    | Part number 2 | Rated voltage [V] | Temperature characteristics |                  | Capacitance [F] | Capacitance tolerance [%] | tan δ [%] | HTLT              | Thickness* <sup>3</sup> [mm] | Soldering R:Reflow W:Wave |
|------------------|---------------|-------------------|-----------------------------|------------------|-----------------|---------------------------|-----------|-------------------|------------------------------|---------------------------|
|                  |               |                   |                             |                  |                 |                           |           | Rated voltage x % |                              |                           |
| TWK107 BJ104MV-T |               | 25                |                             | X5R <sup>+</sup> | 0.1 μ           | ±20                       | 5         | 150               | 0.5±0.05                     | R                         |
| EWK107 BJ224MV-T |               | 16                |                             | X5R <sup>+</sup> | 0.22 μ          | ±20                       | 5         | 150               | 0.5±0.05                     | R                         |
| EWK107 BJ474MV-T |               |                   |                             | X5R <sup>+</sup> | 0.47 μ          | ±20                       | 5         | 150               | 0.5±0.05                     | R                         |
| LWK107 BJ105MV-T |               | 10                |                             | X5R              | 1 μ             | ±20                       | 10        | 150               | 0.5±0.05                     | R                         |
| LWK107 BJ225MV-T |               |                   |                             | X5R              | 2.2 μ           | ±20                       | 10        | 150               | 0.5±0.05                     | R                         |
| JWK107 BJ105MV-T |               | 6.3               |                             | X5R <sup>+</sup> | 1 μ             | ±20                       | 10        | 150               | 0.5±0.05                     | R                         |
| JWK107 BJ225MV-T |               |                   |                             | X5R              | 2.2 μ           | ±20                       | 10        | 150               | 0.5±0.05                     | R                         |
| JWK107 BJ475MV-T |               |                   |                             | X5R              | 4.7 μ           | ±20                       | 10        | 150               | 0.5±0.05                     | R                         |
| AWK107 BJ106MV-T |               | 4                 |                             | X5R              | 10 μ            | ±20                       | 10        | 150               | 0.5±0.05                     | R                         |

[Temperature Characteristic B7 : X7R, C6 : X6S, C7 : X7S] 0.5mm thickness(V)

| Part number 1    | Part number 2 | Rated voltage [V] | Temperature characteristics |     | Capacitance [F] | Capacitance tolerance [%] | tan δ [%] | HTLT              | Thickness* <sup>3</sup> [mm] | Soldering R:Reflow W:Wave |
|------------------|---------------|-------------------|-----------------------------|-----|-----------------|---------------------------|-----------|-------------------|------------------------------|---------------------------|
|                  |               |                   |                             |     |                 |                           |           | Rated voltage x % |                              |                           |
| TWK107 B7104MV-T |               | 25                |                             | X7R | 0.1 μ           | ±20                       | 5         | 150               | 0.5±0.05                     | R                         |
| EWK107 B7224MV-T |               | 16                |                             | X7R | 0.22 μ          | ±20                       | 5         | 150               | 0.5±0.05                     | R                         |
| EWK107 B7474MV-T |               |                   |                             | X7R | 0.47 μ          | ±20                       | 5         | 150               | 0.5±0.05                     | R                         |
| JWK107 C7105MV-T |               | 6.3               |                             | X7S | 1 μ             | ±20                       | 10        | 150               | 0.5±0.05                     | R                         |
| AWK107 C7225MV-T |               | 4                 |                             | X7S | 2.2 μ           | ±20                       | 10        | 150               | 0.5±0.05                     | R                         |
| AWK107 C6475MV-T |               |                   |                             | X6S | 4.7 μ           | ±20                       | 10        | 150               | 0.5±0.05                     | R                         |
| PWK107 C6106MV-T |               | 2.5               |                             | X6S | 10 μ            | ±20                       | 10        | 150               | 0.5±0.05                     | R                         |



# Multilayer Ceramic Capacitors

## PACKAGING

### ① Minimum Quantity

#### ● Taped package

| Type(EIA)      | Thickness |      | Standard quantity [pcs] |                 |      |
|----------------|-----------|------|-------------------------|-----------------|------|
|                | mm        | code | Paper tape              | Embossed tape   |      |
| □MK042(01005)  | 0.2       | C, D | —                       | 40000           |      |
| □VS042(01005)  | 0.2       | C    |                         |                 |      |
| □MK063(0201)   | 0.3       | P, T | 15000                   | —               |      |
| □WK105(0204) ※ | 0.3       | P    | 10000                   |                 |      |
| □MK105(0402)   | 0.2       | C    | 20000                   |                 |      |
|                | 0.3       | P    | 15000                   |                 |      |
|                | 0.5       | V    | 10000                   |                 |      |
| □VK105(0402) ※ | 0.5       | W    |                         |                 |      |
| □MK107(0603)   | 0.45      | K    | 4000                    |                 | 4000 |
| □WK107(0306) ※ | 0.5       | V    | —                       |                 |      |
| □MR107(0603)   | 0.8       | A    | 4000                    |                 |      |
| □MK212(0805)   | 0.45      | K    |                         |                 |      |
| □WK212(0508) ※ | 0.85      | D    |                         |                 |      |
| □MR212(0805)   | 1.25      | G    | —                       | 3000            |      |
| □MK316(1206)   | 0.85      | D    | 4000                    | —               |      |
|                | 1.15      | F    | —                       | 3000            |      |
|                | 1.25      | G    | —                       | 2000            |      |
| □MK325(1210)   | 0.85      | D    | —                       | 2000            |      |
|                | 1.15      | F    |                         |                 |      |
|                | 1.9       | N    |                         |                 |      |
|                | 2.0max.   | Y    |                         |                 |      |
|                | 2.5       | M    |                         |                 |      |
| □MR325(1210)   | 2.5       | M    | —                       | 500(T), 1000(P) |      |
| □MK432(1812)   | 2.5       | M    | —                       | 500             |      |

Note : ※ LW Reverse type.

### ② Taping material

※No bottom tape for pressed carrier tape

#### ● Card board carrier tape

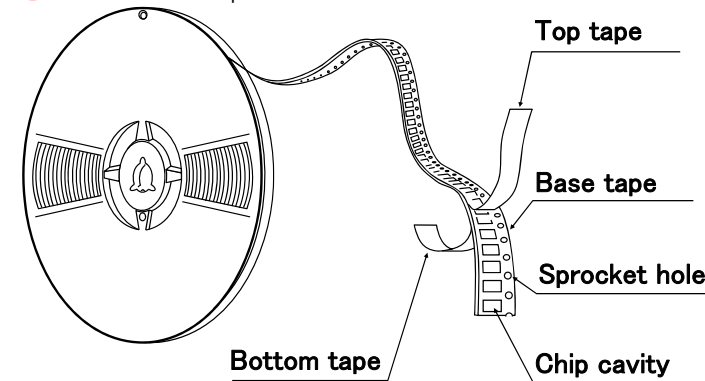

#### ● Embossed tape

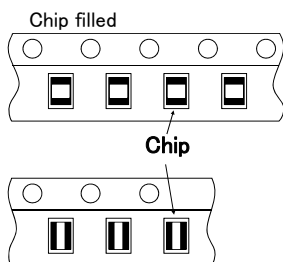
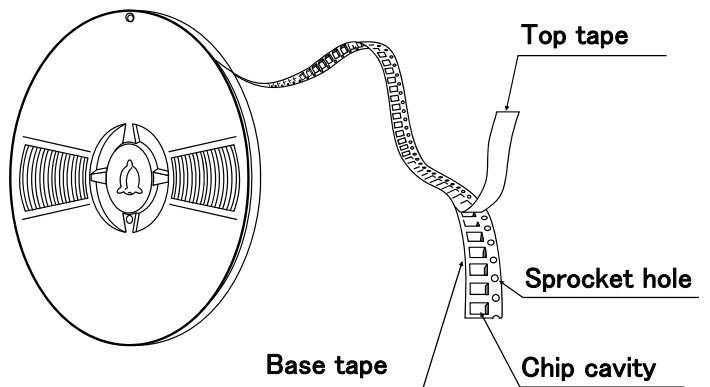

▶ This catalog contains the typical specification only due to the limitation of space. When you consider the purchase of our products, please check our specification. For details of each product (characteristics graph, reliability information, precautions for use, and so on), see our Web site (<http://www.ty-top.com/>).

### ③ Representative taping dimensions

● Paper Tape (8mm wide)

● Pressed carrier tape ( 2mm pitch)

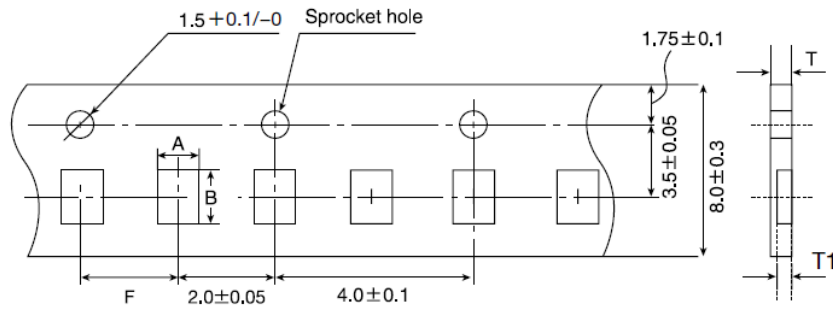

Unit : mm

| Type(EIA)           | Chip Cavity |      | Insertion Pitch<br>F | Tape Thickness |          |
|---------------------|-------------|------|----------------------|----------------|----------|
|                     | A           | B    |                      | T              | T1       |
| □MK063(0201)        | 0.37        | 0.67 | 2.0±0.05             | 0.45max.       | 0.42max. |
| □WK105(0204) ※      | 0.65        | 1.15 |                      | 0.4max.        | 0.3max.  |
| □MK105(0402) (*1 C) |             |      |                      | 0.45max.       | 0.42max. |
| □MK105(0402) (*1 P) |             |      |                      |                |          |

Note \*1 Thickness, C:0.2mm ,P:0.3mm. ※ LW Reverse type.

Unit : mm

● Punched carrier tape (2mm pitch)

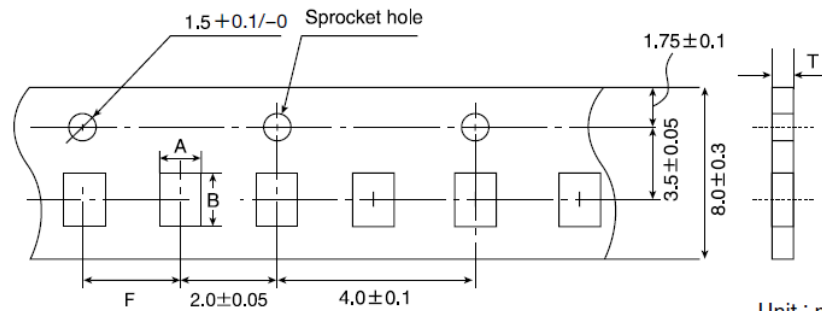

Unit : mm

| Type(EIA)     | Chip Cavity |      | Insertion Pitch<br>F | Tape Thickness |
|---------------|-------------|------|----------------------|----------------|
|               | A           | B    |                      | T              |
| □MK105 (0402) | 0.65        | 1.15 | 2.0±0.05             | 0.8max.        |
| □VK105 (0402) |             |      |                      |                |

Unit : mm

● Punched carrier tape (4mm pitch)

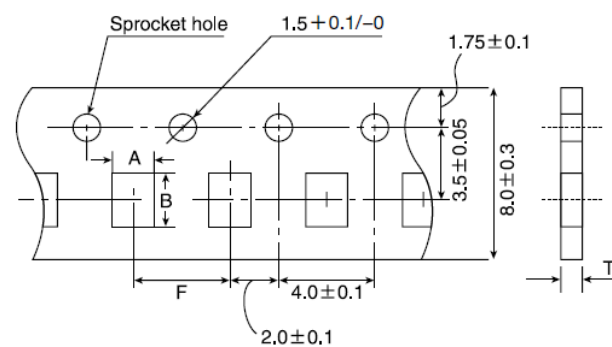

Unit : mm

| Type(EIA)      | Chip Cavity |     | Insertion Pitch<br>F | Tape Thickness |
|----------------|-------------|-----|----------------------|----------------|
|                | A           | B   |                      | T              |
| □MK107(0603)   | 1.0         | 1.8 | 4.0±0.1              | 1.1max.        |
| □WK107(0306) ※ |             |     |                      | 1.1max.        |
| □MR107(0603)   |             |     |                      |                |
| □MK212(0805)   | 1.65        | 2.4 |                      | 1.1max.        |
| □WK212(0508) ※ |             |     |                      |                |
| □MK316(1206)   | 2.0         | 3.6 |                      |                |

Note : Taping size might be different depending on the size of the product. ※ LW Reverse type.

Unit : mm

● Embossed tape (4mm wide)

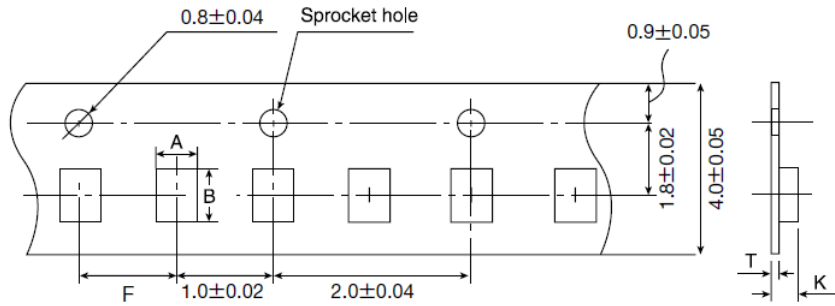

Unit : mm

| Type(EIA)     | Chip Cavity |      | Insertion Pitch<br>F | Tape Thickness |          |
|---------------|-------------|------|----------------------|----------------|----------|
|               | A           | B    |                      | K              | T        |
| □MK042(01005) | 0.23        | 0.43 | 1.0±0.02             | 0.5max.        | 0.25max. |
| □VS042(01005) |             |      |                      |                |          |

Unit : mm

● Embossed tape (8mm wide)

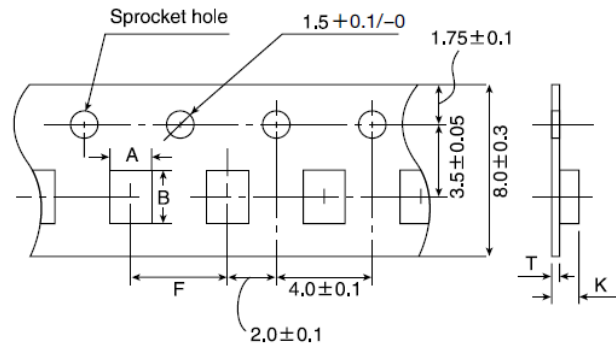

Unit : mm

| Type(EIA)      | Chip Cavity |     | Insertion Pitch<br>F | Tape Thickness |          |
|----------------|-------------|-----|----------------------|----------------|----------|
|                | A           | B   |                      | K              | T        |
| □WK107(0306) ※ | 1.0         | 1.8 | 4.0±0.1              | 1.3max.        | 0.25±0.1 |
| □MK212(0805)   | 1.65        | 2.4 |                      | 3.4max.        | 0.6max.  |
| □MR212(0805)   |             |     |                      |                |          |
| □MK316(1206)   | 2.0         | 3.6 |                      |                |          |
| □MR316(1206)   |             |     |                      |                |          |
| □MK325(1210)   | 2.8         | 3.6 |                      |                |          |
| □MR325(1210)   |             |     |                      |                |          |

Note: ※ LW Reverse type.

Unit : mm

● Embossed tape (12mm wide)

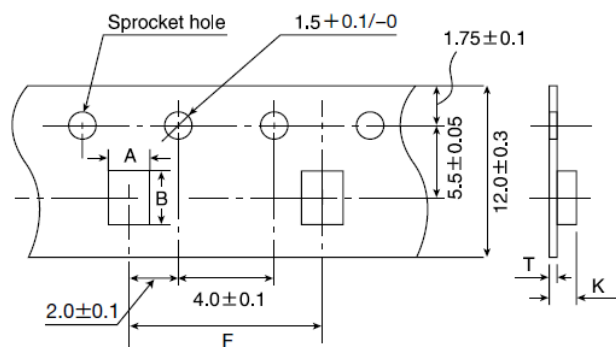

Unit : mm

| Type(EIA)    | Chip Cavity |     | Insertion Pitch<br>F | Tape Thickness |         |
|--------------|-------------|-----|----------------------|----------------|---------|
|              | A           | B   |                      | K              | T       |
| □MK432(1812) | 3.7         | 4.9 | 8.0±0.1              | 4.0max.        | 0.6max. |

Unit : mm

▶ This catalog contains the typical specification only due to the limitation of space. When you consider the purchase of our products, please check our specification. For details of each product (characteristics graph, reliability information, precautions for use, and so on), see our Web site (<http://www.ty-top.com/>).

#### ④Trailer and Leader

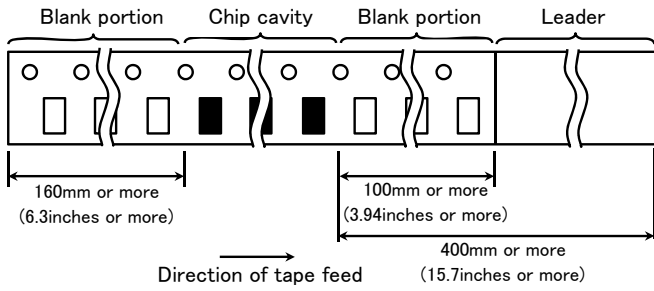

#### ⑤Reel size

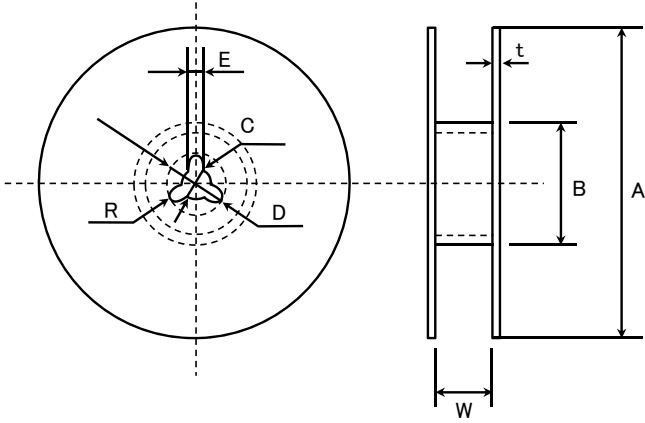

| A                  | B                     | C                   | D                   | E             | R   |
|--------------------|-----------------------|---------------------|---------------------|---------------|-----|
| $\phi 178 \pm 2.0$ | $\phi 50 \text{min.}$ | $\phi 13.0 \pm 0.2$ | $\phi 21.0 \pm 0.8$ | $2.0 \pm 0.5$ | 1.0 |
|                    | T                     | W                   |                     |               |     |
| 4mm wide tape      | 1.5max.               | $5 \pm 1.0$         |                     |               |     |
| 8mm wide tape      | 2.5max.               | $10 \pm 1.5$        |                     |               |     |
| 12mm wide tape     | 2.5max.               | $14 \pm 1.5$        |                     |               |     |

Unit: mm

#### ⑥Top Tape Strength

The top tape requires a peel-off force of 0.1 to 0.7N in the direction of the arrow as illustrated below.

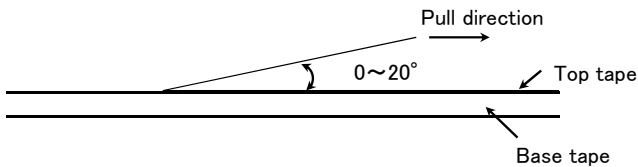

#### ⑦Bulk Cassette

The exchange of individual specification is necessary.  
Please contact Taiyo Yuden sales channels.

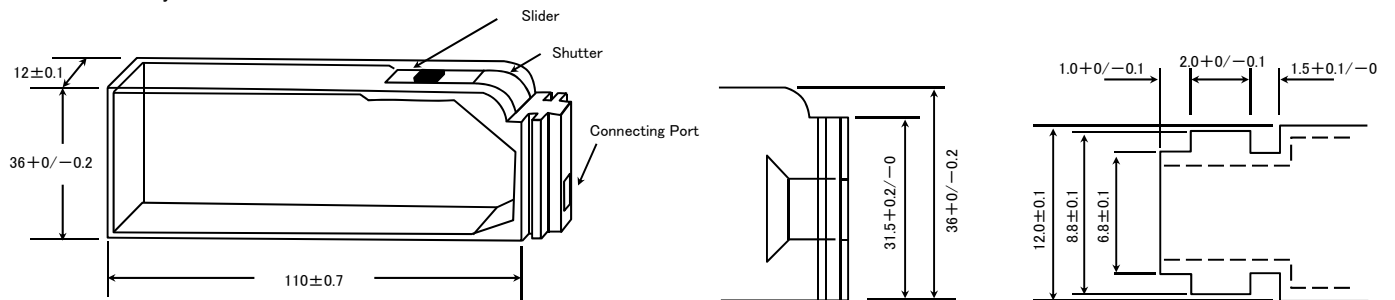

Unit: mm

# Medium-High Voltage Multilayer Ceramic Capacitor

## RELIABILITY DATA

| 1. Operating Temperature Range               |  |               |   |               |   |                               |  |   |      |      |   |                               |  |
|--|--|---------------|---|---------------|---|-------------------------------|--|---|------|------|---|-------------------------------|--|
| Specified Value                              | X7R, X7S : -55 to +125°C<br>X5R : -55 to +85°C<br>B : -25 to +85°C   |               |   |               |   |                               |  |   |      |      |   |                               |  |
| 2. Storage Temperature Range                 |  |               |   |               |   |                               |  |   |      |      |   |                               |  |
| Specified Value                              | X7R, X7S : -55 to +125°C<br>X5R : -55 to +85°C<br>B : -25 to +85°C   |               |   |               |   |                               |  |   |      |      |   |                               |  |
| 3. Rated Voltage                             |  |               |   |               |   |                               |  |   |      |      |   |                               |  |
| Specified Value                              | 100VDC(HMK), 250VDC(QMK), 630VDC(SMK)  |               |   |               |   |                               |  |   |      |      |   |                               |  |
| 4. Withstanding Voltage (Between terminals)  |  |               |   |               |   |                               |  |   |      |      |   |                               |  |
| Specified Value                              | No breakdown or damage   |               |   |               |   |                               |  |   |      |      |   |                               |  |
| Test Methods and Remarks                     | Applied voltage : Rated voltage × 2.5 (HMK), Rated voltage × 2 (QMK), Rated voltage × 1.2 (SMK)<br>Duration : 1 to 5sec.<br>Charge/discharge current : 50mA max.   |               |   |               |   |                               |  |   |      |      |   |                               |  |
| 5. Insulation Resistance                     |  |               |   |               |   |                               |  |   |      |      |   |                               |  |
| Specified Value                              | 100MΩ · μF or 10GΩ, whichever is smaller.  |               |   |               |   |                               |  |   |      |      |   |                               |  |
| Test Methods and Remarks                     | Applied voltage : Rated voltage (HMK, QMK), 500V (SMK)<br>Duration : 60±5sec.<br>Charge/discharge current : 50mA max.  |               |   |               |   |                               |  |   |      |      |   |                               |  |
| 6. Capacitance (Tolerance)                   |  |               |   |               |   |                               |  |   |      |      |   |                               |  |
| Specified Value                              | ±10%, ±20%   |               |   |               |   |                               |  |   |      |      |   |                               |  |
| Test Methods and Remarks                     | Measuring frequency : 1kHz±10%<br>Measuring voltage : 1±0.2Vrms<br>Bias application : None   |               |   |               |   |                               |  |   |      |      |   |                               |  |
| 7. Dissipation Factor                        |  |               |   |               |   |                               |  |   |      |      |   |                               |  |
| Specified Value                              | 3.5%max (HMK)<br>2.5%max (QMK, SMK)  |               |   |               |   |                               |  |   |      |      |   |                               |  |
| Test Methods and Remarks                     | Measuring frequency : 1kHz±10%<br>Measuring voltage : 1±0.2Vrms<br>Bias application : None   |               |   |               |   |                               |  |   |      |      |   |                               |  |
| 8. Temperature Characteristic of Capacitance |  |               |   |               |   |                               |  |   |      |      |   |                               |  |
| Specified Value                              | B : ±10% (-25 to +85°C)<br>X5R : ±15% (-55 to +85°C)<br>X7R : ±15% (-55 to +125°C)<br>X7S : ±22% (-55 to +125°C)   |               |   |               |   |                               |  |   |      |      |   |                               |  |
| Test Methods and Remarks                     | Capacitance value at each step shall be measured in thermal equilibrium, and the temperature characteristic shall be calculated from the following equation.<br><table border="1" style="margin-left: 20px;"> <thead> <tr> <th>Step</th> <th>B</th> <th>X5R, X7R, X7S</th> </tr> </thead> <tbody> <tr> <td>1</td> <td colspan="2">Minimum operating temperature</td> </tr> <tr> <td>2</td> <td>20°C</td> <td>25°C</td> </tr> <tr> <td>3</td> <td colspan="2">Maximum operating temperature</td> </tr> </tbody> </table> $\frac{(C - C_2)}{C_2} \times 100(\%)$ <p>C : Capacitance value in Step 1 or Step 3<br/>C2 : Capacitance value in Step 2</p> | Step          | B | X5R, X7R, X7S | 1 | Minimum operating temperature |  | 2 | 20°C | 25°C | 3 | Maximum operating temperature |  |
| Step   | B  | X5R, X7R, X7S |   |               |   |                               |  |   |      |      |   |                               |  |
| 1  | Minimum operating temperature  |               |   |               |   |                               |  |   |      |      |   |                               |  |
| 2  | 20°C   | 25°C          |   |               |   |                               |  |   |      |      |   |                               |  |
| 3  | Maximum operating temperature  |               |   |               |   |                               |  |   |      |      |   |                               |  |

▶ This catalog contains the typical specification only due to the limitation of space. When you consider the purchase of our products, please check our specification. For details of each product (characteristics graph, reliability information, precautions for use, and so on), see our Web site (<http://www.ty-top.com/>).

### 9. Deflection

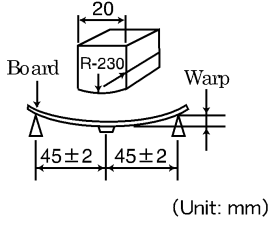
|                          |  |
|--------------------------|--|
| Specified Value          | Appearance : No abnormality<br>Capacitance change : Within $\pm 10\%$  |
| Test Methods and Remarks | <p>Warp : 1mm<br/>Duration : 10sec.<br/>Test board : Glass epoxy-resin substrate<br/>Thickness : 1.6mm</p>  <p>(Unit: mm)</p> <p>Capacitance measurement shall be conducted with the board bent.</p> |

### 10. Adhesive Strength of Terminal Electrodes

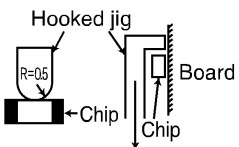
|                          |  |
|--------------------------|--|
| Specified Value          | No terminal separation or its indication.  |
| Test Methods and Remarks | <p>Applied force : 5N<br/>Duration : <math>30 \pm 5</math>sec.</p>  |

### 11. Solderability

|                          |   |                           |                           |
|--------------------------|---|---------------------------|---------------------------|
| Specified Value          | At least 95% of terminal electrode is covered by new solder |                           |                           |
| Test Methods and Remarks |   | Eutectic solder           | Lead-free solder          |
|                          | Solder type   | H60A or H63A              | Sn-3.0Ag-0.5Cu            |
|                          | Solder temperature  | $230 \pm 5^\circ\text{C}$ | $245 \pm 3^\circ\text{C}$ |
|                          | Duration  | $4 \pm 1$ sec.            |                           |

### 12. Resistance to Soldering

|                          |   |
|--------------------------|---|
| Specified Value          | Appearance : No abnormality<br>Capacitance change : Within $\pm 15\%$ (HMK), $\pm 10\%$ (QMK, SMK)<br>Dissipation factor : Initial value<br>Insulation resistance : Initial value<br>Withstanding voltage (between terminals) : No abnormality  |
| Test Methods and Remarks | <p>Preconditioning : Thermal treatment (at <math>150^\circ\text{C}</math> for 1hr) Note1<br/>Solder temperature : <math>270 \pm 5^\circ\text{C}</math><br/>Duration : <math>3 \pm 0.5</math>sec.<br/>Preheating conditions : <math>80</math> to <math>100^\circ\text{C}</math>, 2 to 5 min.<br/><math>150</math> to <math>200^\circ\text{C}</math>, 2 to 5min.<br/>Recovery : <math>24 \pm 2</math>hrs under the standard condition Note3</p> |

### 13. Temperature Cycle (Thermal Shock)

| Specified Value          | Appearance : No abnormality<br>Capacitance change : Within $\pm 15\%$ (HMK), $\pm 7.5\%$ (QMK, SMK)<br>Dissipation factor : Initial value<br>Insulation resistance : Initial value  |                 |                                  |             |   |                               |                 |   |                    |            |   |                               |                 |   |                    |            |
|--------------------------|---|-----------------|----------------------------------|-------------|---|-------------------------------|-----------------|---|--------------------|------------|---|-------------------------------|-----------------|---|--------------------|------------|
| Test Methods and Remarks | <p>Preconditioning : Thermal treatment (at <math>150^\circ\text{C}</math> for 1hr) Note1<br/>Conditions for 1 cycle</p> <table border="1"> <thead> <tr> <th>Step</th> <th>Temperature (<math>^\circ\text{C}</math>)</th> <th>Time (min.)</th> </tr> </thead> <tbody> <tr> <td>1</td> <td>Minimum operating temperature</td> <td><math>30 \pm 3</math>min.</td> </tr> <tr> <td>2</td> <td>Normal temperature</td> <td>2 to 3min.</td> </tr> <tr> <td>3</td> <td>Maximum operating temperature</td> <td><math>30 \pm 3</math>min.</td> </tr> <tr> <td>4</td> <td>Normal temperature</td> <td>2 to 3min.</td> </tr> </tbody> </table> <p>Number of cycles : 5 times<br/>Recovery : <math>24 \pm 2</math>hrs under the standard condition Note3</p> | Step            | Temperature ( $^\circ\text{C}$ ) | Time (min.) | 1 | Minimum operating temperature | $30 \pm 3$ min. | 2 | Normal temperature | 2 to 3min. | 3 | Maximum operating temperature | $30 \pm 3$ min. | 4 | Normal temperature | 2 to 3min. |
| Step                     | Temperature ( $^\circ\text{C}$ )  | Time (min.)     |                                  |             |   |                               |                 |   |                    |            |   |                               |                 |   |                    |            |
| 1                        | Minimum operating temperature   | $30 \pm 3$ min. |                                  |             |   |                               |                 |   |                    |            |   |                               |                 |   |                    |            |
| 2                        | Normal temperature  | 2 to 3min.      |                                  |             |   |                               |                 |   |                    |            |   |                               |                 |   |                    |            |
| 3                        | Maximum operating temperature   | $30 \pm 3$ min. |                                  |             |   |                               |                 |   |                    |            |   |                               |                 |   |                    |            |
| 4                        | Normal temperature  | 2 to 3min.      |                                  |             |   |                               |                 |   |                    |            |   |                               |                 |   |                    |            |

▶ This catalog contains the typical specification only due to the limitation of space. When you consider the purchase of our products, please check our specification. For details of each product (characteristics graph, reliability information, precautions for use, and so on), see our Web site (<http://www.ty-top.com/>).

| 14. Humidity (Steady state)  |  |
|--|--|
| Specified Value  | Appearance : No abnormality<br>Capacitance change : Within $\pm 15\%$<br>Dissipation factor : $7\%_{\max}$ (HMK), $5\%_{\max}$ (QMK, SMK).<br>Insulation resistance : $25M \Omega \mu F$ or $1000M \Omega$ , whichever is smaller.   |
| Test Methods and Remarks   | Preconditioning : Thermal treatment (at $150^{\circ}C$ for 1hr) Note1<br>Temperature : $40 \pm 2^{\circ}C$<br>Humidity : 90 to 95%RH<br>Duration : 500 +24/−0 hrs<br>Recovery : $24 \pm 2$ hrs under the standard condition Note3  |
| 15. Humidity Loading   |  |
| Specified Value  | Appearance : No abnormality<br>Capacitance change : Within $\pm 15\%$<br>Dissipation factor : $7\%_{\max}$ (HMK), $5\%_{\max}$ (QMK, SMK).<br>Insulation resistance : $10M \Omega \mu F$ or $500M \Omega$ , whichever is smaller.  |
| Test Methods and Remarks   | According to JIS 5102 clause 9.9.<br>Preconditioning : Voltage treatment Note2<br>Temperature : $40 \pm 2^{\circ}C$<br>Humidity : 90 to 95%RH<br>Applied voltage : Rated voltage<br>Charge/discharge current : 50mA max.<br>Duration : 500 +24/−0 hrs<br>Recovery : $24 \pm 2$ hrs under the standard condition Note3  |
| 16. High Temperature Loading   |  |
| Specified Value  | Appearance : No abnormality<br>Capacitance change : Within $\pm 15\%$<br>Dissipation factor : $7\%_{\max}$ (HMK), $5\%_{\max}$ (QMK, SMK).<br>Insulation resistance : $50M \Omega \mu F$ or $1000M \Omega$ , whichever is smaller.   |
| Test Methods and Remarks   | According to JIS 5102 clause 9.10.<br>Preconditioning : Voltage treatment Note2<br>Temperature : Maximum operating temperature<br>Applied voltage : Rated voltage $\times 2$ (HMK)<br>Rated voltage $\times 1.5$ (QMK)<br>Rated voltage $\times 1.2$ (SMK)<br>Charge/discharge current : 50mA max.<br>Duration : 1000 +24/−0 hrs<br>Recovery : $24 \pm 2$ hrs under the standard condition Note3 |
| Note1 Thermal treatment : Initial value shall be measured after test sample is heat-treated at $150 \pm 0 / - 10^{\circ}C$ for an hour and kept at room temperature for $24 \pm 2$ hours.  |  |
| Note2 Voltage treatment : Initial value shall be measured after test sample is voltage-treated for an hour at both the temperature and voltage specified in the test conditions, and kept at room temperature for $24 \pm 2$ hours.  |  |
| Note3 Standard condition : Temperature: 5 to $35^{\circ}C$ , Relative humidity: 45 to 85 % RH, Air pressure: 86 to 106kPa<br>When there are questions concerning measurement results, in order to provide correlation data, the test shall be conducted under the following condition.<br>Temperature: $20 \pm 2^{\circ}C$ , Relative humidity: 60 to 70 % RH, Air pressure: 86 to 106kPa<br>Unless otherwise specified, all the tests are conducted under the "standard condition". |  |

# Precautions on the use of Multilayer Ceramic Capacitors

## PRECAUTIONS

### 1. Circuit Design

- Precautions**
- ◆ Verification of operating environment, electrical rating and performance
    1. A malfunction of equipment in fields such as medical, aerospace, nuclear control, etc. may cause serious harm to human life or have severe social ramifications. Therefore, any capacitors to be used in such equipment may require higher safety and reliability, and shall be clearly differentiated from them used in general purpose applications.
  - ◆ Operating Voltage (Verification of Rated voltage)
    1. The operating voltage for capacitors must always be their rated voltage or less.
      - If an AC voltage is loaded on a DC voltage, the sum of the two peak voltages shall be the rated voltage or less.
      - For a circuit where an AC or a pulse voltage may be used, the sum of their peak voltages shall also be the rated voltage or less.
    2. Even if an applied voltage is the rated voltage or less reliability of capacitors may be deteriorated in case that either a high frequency AC voltage or a pulse voltage having rapid rise time is used in a circuit.

### 2. PCB Design

- Precautions**
- ◆ Pattern configurations (Design of Land-patterns)
    1. When capacitors are mounted on PCBs, the amount of solder used (size of fillet) can directly affect the capacitor performance. Therefore, the following items must be carefully considered in the design of land patterns:
      - (1) Excessive solder applied can cause mechanical stresses which lead to chip breaking or cracking. Therefore, please consider appropriate land-patterns for proper amount of solder.
      - (2) When more than one component are jointly soldered onto the same land, each component's soldering point shall be separated by solder-resist.
  - ◆ Pattern configurations (Capacitor layout on PCBs)
 

After capacitors are mounted on boards, they can be subjected to mechanical stresses in subsequent manufacturing processes (PCB cutting, board inspection, mounting of additional parts, assembly into the chassis, wave soldering of the boards, etc.). For this reason, land pattern configurations and positions of capacitors shall be carefully considered to minimize stresses.

**Technical considerations**

- ◆ Pattern configurations (Design of Land-patterns)
 

The following diagrams and tables show some examples of recommended land patterns to prevent excessive solder amounts.

(1) Recommended land dimensions for typical chip capacitors

● Multilayer Ceramic Capacitors : Recommended land dimensions (unit: mm)

|      |   | Wave-soldering |            |            |            |
|------|---|----------------|------------|------------|------------|
| Type |   | 107            | 212        | 316        | 325        |
| Size | L | 1.6            | 2.0        | 3.2        | 3.2        |
|      | W | 0.8            | 1.25       | 1.6        | 2.5        |
| A    |   | 0.8 to 1.0     | 1.0 to 1.4 | 1.8 to 2.5 | 1.8 to 2.5 |
| B    |   | 0.5 to 0.8     | 0.8 to 1.5 | 0.8 to 1.7 | 0.8 to 1.7 |
| C    |   | 0.6 to 0.8     | 0.9 to 1.2 | 1.2 to 1.6 | 1.8 to 2.5 |

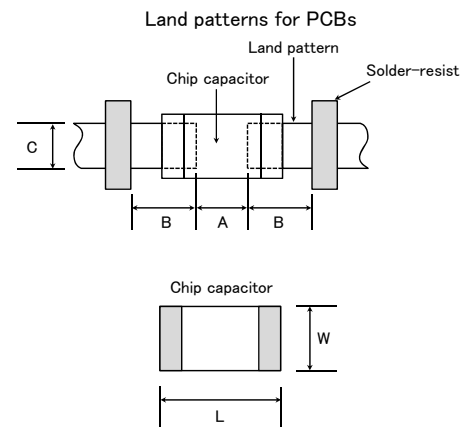

|      |   | Reflow-soldering |              |              |            |            |            |            |            |
|------|---|------------------|--------------|--------------|------------|------------|------------|------------|------------|
| Type |   | 042              | 063          | 105          | 107        | 212        | 316        | 325        | 432        |
| Size | L | 0.4              | 0.6          | 1.0          | 1.6        | 2.0        | 3.2        | 3.2        | 4.5        |
|      | W | 0.2              | 0.3          | 0.5          | 0.8        | 1.25       | 1.6        | 2.5        | 3.2        |
| A    |   | 0.15 to 0.25     | 0.20 to 0.30 | 0.45 to 0.55 | 0.8 to 1.0 | 0.8 to 1.2 | 1.8 to 2.5 | 1.8 to 2.5 | 2.5 to 3.5 |
| B    |   | 0.15 to 0.20     | 0.20 to 0.30 | 0.40 to 0.50 | 0.6 to 0.8 | 0.8 to 1.2 | 1.0 to 1.5 | 1.0 to 1.5 | 1.5 to 1.8 |
| C    |   | 0.15 to 0.30     | 0.25 to 0.40 | 0.45 to 0.55 | 0.6 to 0.8 | 0.9 to 1.6 | 1.2 to 2.0 | 1.8 to 3.2 | 2.3 to 3.5 |

Note: Recommended land size might be different according to the allowance of the size of the product.

● LWDC: Recommended land dimensions for reflow-soldering (unit: mm)

| Type |   | 105          | 107         | 212        |
|------|---|--------------|-------------|------------|
| Size | L | 0.52         | 0.8         | 1.25       |
|      | W | 1.0          | 1.6         | 2.0        |
| A    |   | 0.18 to 0.22 | 0.25 to 0.3 | 0.5 to 0.7 |
| B    |   | 0.2 to 0.25  | 0.3 to 0.4  | 0.4 to 0.5 |
| C    |   | 0.9 to 1.1   | 1.5 to 1.7  | 1.9 to 2.1 |

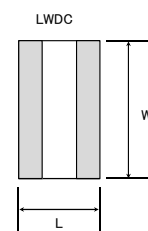

▶ This catalog contains the typical specification only due to the limitation of space. When you consider the purchase of our products, please check our specification. For details of each product (characteristics graph, reliability information, precautions for use, and so on), see our Web site (<http://www.ty-top.com/>).



(2) Examples of good and bad solder application

| Item  | Not recommended | Recommended |
|---|-----------------|-------------|
| Mixed mounting of SMD and leaded components                 |                 |             |
| Component placement close to the chassis                    |                 |             |
| Hand-soldering of leaded components near mounted components |                 |             |
| Horizontal component placement                              |                 |             |

◆ Pattern configurations (Capacitor layout on PCBs)

1-1. The following is examples of good and bad capacitor layouts ; capacitors shall be located to minimize any possible mechanical stresses from board warp or deflection.

| Items               | Not recommended | Recommended |
|---------------------|-----------------|-------------|
| Deflection of board |                 |             |

1-2. The amount of mechanical stresses given will vary depending on capacitor layout. Please refer to diagram below.

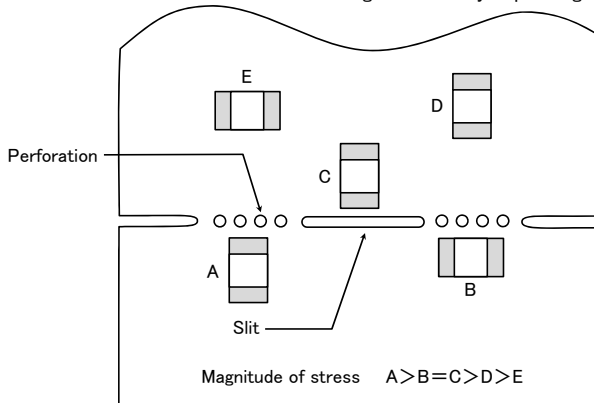

1-3. When PCB is split, the amount of mechanical stress on the capacitors can vary according to the method used. The following methods are listed in order from least stressful to most stressful: push-back, slit, V-grooving, and perforation. Thus, please consider the PCB, split methods as well as chip location.

3. Mounting

Precautions

◆ Adjustment of mounting machine

- When capacitors are mounted on PCB, excessive impact load shall not be imposed on them.
- Maintenance and inspection of mounting machines shall be conducted periodically.

◆ Selection of Adhesives

- When chips are attached on PCBs with adhesives prior to soldering, it may cause capacitor characteristics degradation unless the following factors are appropriately checked : size of land patterns, type of adhesive, amount applied, hardening temperature and hardening period. Therefore, please contact us for further information.

◆Adjustment of mounting machine

1. When the bottom dead center of a pick-up nozzle is too low, excessive force is imposed on capacitors and causes damages. To avoid this, the following points shall be considerable.
  - (1) The bottom dead center of the pick-up nozzle shall be adjusted to the surface level of PCB without the board deflection.
  - (2) The pressure of nozzle shall be adjusted between 1 and 3 N static loads.
  - (3) To reduce the amount of deflection of the board caused by impact of the pick-up nozzle, supporting pins or back-up pins shall be used on the other side of the PCB. The following diagrams show some typical examples of good and bad pick-up nozzle placement:

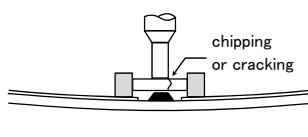
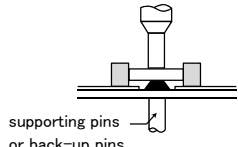
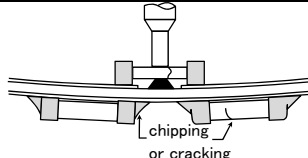
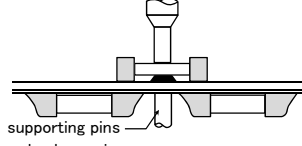
| Item                  | Improper method   | Proper method   |
|-----------------------|---|---|
| Single-sided mounting |  |  |
| Double-sided mounting |  |  |

Technical considerations

2. As the alignment pin is worn out, adjustment of the nozzle height can cause chipping or cracking of capacitors because of mechanical impact on the capacitors.  
To avoid this, the monitoring of the width between the alignment pins in the stopped position, maintenance, check and replacement of the pin shall be conducted periodically.

◆Selection of Adhesives

Some adhesives may cause IR deterioration. The different shrinkage percentage of between the adhesive and the capacitors may result in stresses on the capacitors and lead to cracking. Moreover, too little or too much adhesive applied to the board may adversely affect components. Therefore, the following precautions shall be noted in the application of adhesives.

- (1) Required adhesive characteristics
  - a. The adhesive shall be strong enough to hold parts on the board during the mounting & solder process.
  - b. The adhesive shall have sufficient strength at high temperatures.
  - c. The adhesive shall have good coating and thickness consistency.
  - d. The adhesive shall be used during its prescribed shelf life.
  - e. The adhesive shall harden rapidly.
  - f. The adhesive shall have corrosion resistance.
  - g. The adhesive shall have excellent insulation characteristics.
  - h. The adhesive shall have no emission of toxic gasses and no effect on the human body.
- (2) The recommended amount of adhesives is as follows;

[Recommended condition]

| Figure | 212/316 case sizes as examples   |
|--------|----------------------------------|
| a      | 0.3mm min                        |
| b      | 100 to 120 μm                    |
| c      | Adhesives shall not contact land |

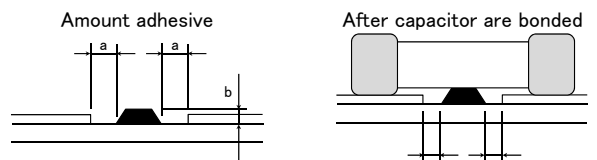

4. Soldering

◆Selection of Flux

- Since flux may have a significant effect on the performance of capacitors, it is necessary to verify the following conditions prior to use;
- (1) Flux used shall be less than or equal to 0.1 wt% ( in Cl equivalent) of halogenated content. Flux having a strong acidity content shall not be applied.
  - (2) When shall capacitors are soldered on boards, the amount of flux applied shall be controlled at the optimum level.
  - (3) When water-soluble flux is used, special care shall be taken to properly clean the boards.

Precautions

◆Soldering

Temperature, time, amount of solder, etc. shall be set in accordance with their recommended conditions.  
Sn-Zn solder paste can adversely affect MLOC reliability.  
Please contact us prior to usage of Sn-Zn solder.

Technical considerations

◆Selection of Flux

- 1-1. When too much halogenated substance (Chlorine, etc.) content is used to activate flux, or highly acidic flux is used, it may lead to corrosion of terminal electrodes or degradation of insulation resistance on the surfaces of the capacitors.
- 1-2. Flux is used to increase solderability in wave soldering. However if too much flux is applied, a large amount of flux gas may be emitted and may adversely affect the solderability. To minimize the amount of flux applied, it is recommended to use a flux-bubbling system.
- 1-3. Since the residue of water-soluble flux is easily dissolved in moisture in the air, the residues on the surfaces of capacitors in high humidity conditions may cause a degradation of insulation resistance and reliability of the capacitors. Therefore, the cleaning methods and the capability of the machines used shall also be considered carefully when water-soluble flux is used.

▶ This catalog contains the typical specification only due to the limitation of space. When you consider the purchase of our products, please check our specification.  
For details of each product (characteristics graph, reliability information, precautions for use, and so on), see our Web site (<http://www.ty-top.com/>).

◆Soldering

- Ceramic chip capacitors are susceptible to thermal shock when exposed to rapid or concentrated heating or rapid cooling.
- Therefore, the soldering must be conducted with great care so as to prevent malfunction of the components due to excessive thermal shock.
- Preheating : Capacitors shall be preheated sufficiently, and the temperature difference between the capacitors and solder shall be within 100 to 130°C.
- Cooling : The temperature difference between the capacitors and cleaning process shall not be greater than 100°C.

[Reflow soldering]

【Recommended conditions for eutectic soldering】

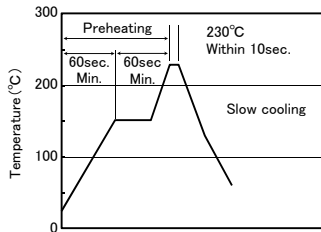

【Recommended condition for Pb-free soldering】

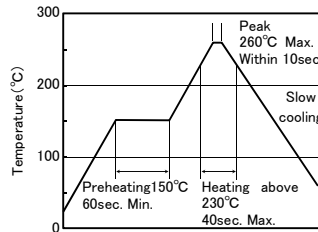

Caution

- ①The ideal condition is to have solder mass(fillet) controlled to 1/2 to 1/3 of the thickness of a capacitor.
- ②Because excessive dwell times can adversely affect solderability, soldering duration shall be kept as close to recommended times as possible.

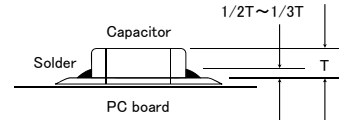

[Wave soldering]

【Recommended conditions for eutectic soldering】

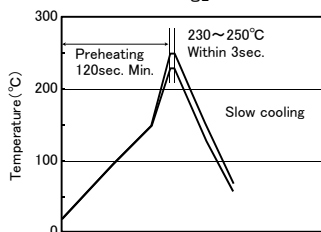

【Recommended condition for Pb-free soldering】

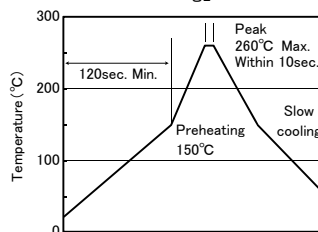

Caution

- ①Wave soldering must not be applied to capacitors designated as for reflow soldering only.

[Hand soldering]

【Recommended conditions for eutectic soldering】

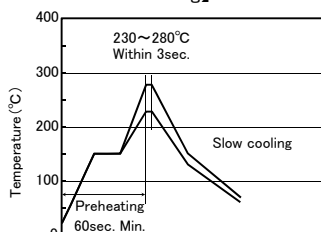

【Recommended condition for Pb-free soldering】

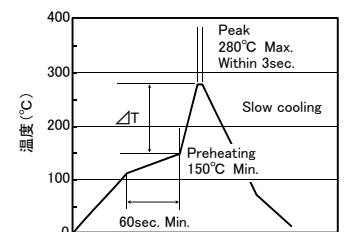
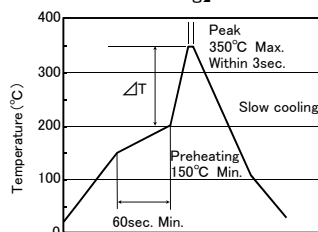

316type or less      ΔT  
ΔT ≤ 150°C

325type or more      ΔT  
ΔT ≤ 130°C

Caution

- ①Use a 50W soldering iron with a maximum tip diameter of 1.0 mm.
- ②The soldering iron shall not directly touch capacitors.

5. Cleaning

◆Cleaning conditions

1. When PCBs are cleaned after capacitors mounting, please select the appropriate cleaning solution in accordance with the intended use of the cleaning. (e.g. to remove soldering flux or other materials from the production process.)
2. Cleaning condition shall be determined after it is verified by using actual cleaning machine that the cleaning process does not affect capacitor's characteristics.

Technical considerations

1. The use of inappropriate cleaning solutions can cause foreign substances such as flux residue to adhere to capacitors or deteriorate their outer coating, resulting in a degradation of the capacitor's electrical properties (especially insulation resistance).
2. Inappropriate cleaning conditions( insufficient or excessive cleaning) may adversely affect the performance of the capacitors. In the case of ultrasonic cleaning, too much power output can cause excessive vibration of PCBs which may lead to the cracking of capacitors or the soldered portion, or decrease the terminal electrodes' strength. Therefore, the following conditions shall be carefully checked:  
 Ultrasonic output : 20 W/l or less  
 Ultrasonic frequency : 40 kHz or less  
 Ultrasonic washing period : 5 min. or less

▶ This catalog contains the typical specification only due to the limitation of space. When you consider the purchase of our products, please check our specification. For details of each product (characteristics graph, reliability information, precautions for use, and so on), see our Web site (<http://www.ty-top.com/>).

| 6. Resin coating and mold   |  |
|---|--|
| Precautions   | <p>1. With some type of resins, decomposition gas or chemical reaction vapor may remain inside the resin during the hardening period or while left under normal storage conditions resulting in the deterioration of the capacitor's performance.</p> <p>2. When a resin's hardening temperature is higher than capacitor's operating temperature, the stresses generated by the excessive heat may lead to damage or destruction of capacitors.<br/>The use of such resins, molding materials etc. is not recommended.</p>  |
| 7. Handling   |  |
| Precautions   | <p>◆Splitting of PCB</p> <p>1. When PCBs are split after components mounting, care shall be taken so as not to give any stresses of deflection or twisting to the board.</p> <p>2. Board separation shall not be done manually, but by using the appropriate devices.</p> <p>◆Mechanical considerations</p> <p>Be careful not to subject capacitors to excessive mechanical shocks.</p> <p>(1) If ceramic capacitors are dropped onto a floor or a hard surface, they shall not be used.</p> <p>(2) Please be careful that the mounted components do not come in contact with or bump against other boards or components.</p>  |
| 8. Storage conditions   |  |
| Precautions   | <p>◆Storage</p> <p>1. To maintain the solderability of terminal electrodes and to keep packaging materials in good condition, care must be taken to control temperature and humidity in the storage area. Humidity should especially be kept as low as possible.</p> <p>•Recommended conditions</p> <p>Ambient temperature : Below 30°C<br/>Humidity : Below 70% RH</p> <p>The ambient temperature must be kept below 40°C. Even under ideal storage conditions, solderability of capacitor is deteriorated as time passes, so capacitors shall be used within 6 months from the time of delivery.</p> <p>•Ceramic chip capacitors shall be kept where no chlorine or sulfur exists in the air.</p> <p>2. The capacitance values of high dielectric constant capacitors will gradually decrease with the passage of time, so care shall be taken to design circuits. Even if capacitance value decreases as time passes, it will get back to the initial value by a heat treatment at 150°C for 1hour.</p> |
| Technical considerations  | <p>If capacitors are stored in a high temperature and humidity environment, it might rapidly cause poor solderability due to terminal oxidation and quality loss of taping/packaging materials. For this reason, capacitors shall be used within 6 months from the time of delivery. If exceeding the above period, please check solderability before using the capacitors.</p>  |
| <p>※RCR-2335B (Safety Application Guide for fixed ceramic capacitors for use in electronic equipment) is published by JEITA.<br/>Please check the guide regarding precautions for deflection test, soldering by spot heat, and so on.</p> |  |