

**OPTION "M"**

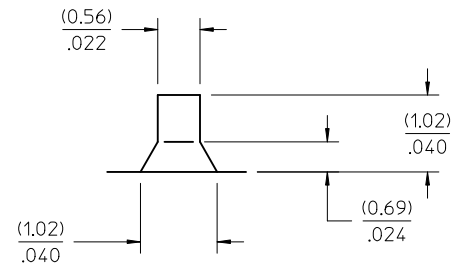

**DETAIL "F"**

TYP. SCALE 20:1

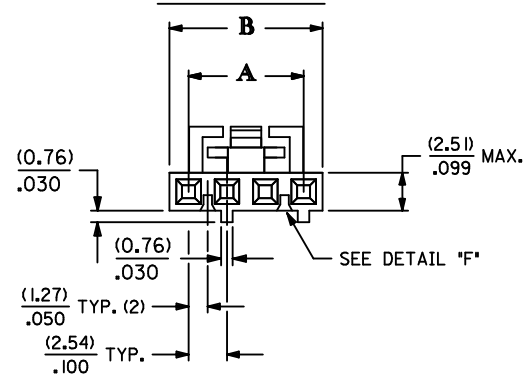
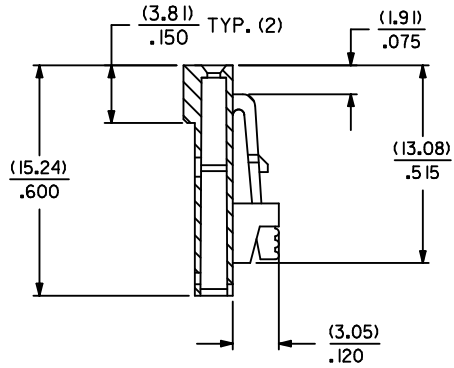
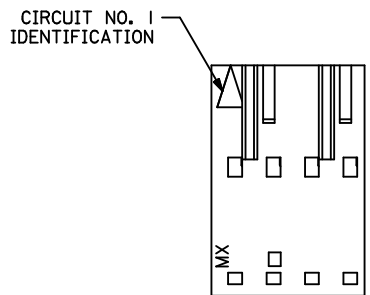

**SECTION C-C**

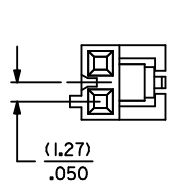
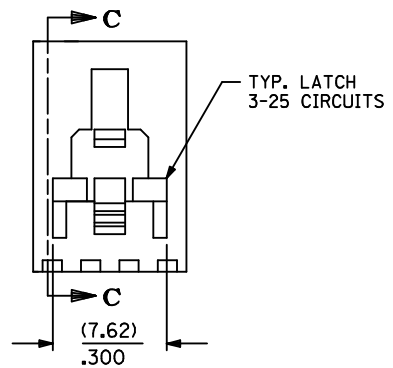

**2 CIRCUIT**

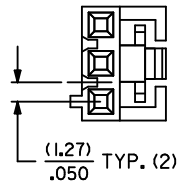

**3 CIRCUIT**

CKT. SIZE	EDP. NO.	ENG. NO.	DIM. A REF.	DIM. B REF.
2	50-57-8902	70066-0351	(2.54) .100	(5.05) .199
3	50-57-8903	70066-0352	(5.08) .200	(7.59) .299
4	50-57-8904	70066-0353	(7.62) .300	(10.13) .399
5	50-57-8905	70066-0354	(10.16) .400	(12.67) .499
6	50-57-8906	70066-0355	(12.70) .500	(15.21) .599
7	50-57-8907	70066-0356	(15.24) .600	(17.75) .699
8	50-57-8908	70066-0357	(17.78) .700	(20.29) .799
9	50-57-8909	70066-0358	(20.32) .800	(22.83) .899
10	50-57-8910	70066-0359	(22.86) .900	(25.37) .999
11	NOT TOOLED	70066-0360	(25.40) 1.000	(27.91) 1.099
12	NOT TOOLED	70066-0361	(27.94) 1.100	(30.45) 1.199
13	NOT TOOLED	70066-0362	(30.48) 1.300	(32.99) 1.399
14	NOT TOOLED	70066-0363	(33.02) 1.400	(35.53) 1.499
15	NOT TOOLED	70066-0364	(35.56) 1.500	(38.07) 1.599
16	NOT TOOLED	70066-0365	(38.10) 1.600	(40.61) 1.699
17	NOT TOOLED	70066-0366	(40.64) 1.700	(43.15) 1.799
18	NOT TOOLED	70066-0367	(43.18) 1.800	(45.69) 1.899
19	NOT TOOLED	70066-0368	(45.72) 1.900	(48.23) 1.999
20	NOT TOOLED	70066-0369	(48.26) 2.000	(50.77) 2.099
21	NOT TOOLED	70066-0370	(50.80) 2.100	(53.31) 2.199
22	NOT TOOLED	70066-0371	(53.34) 2.200	(55.85) 2.299
23	NOT TOOLED	70066-0372	(55.88) 2.300	(58.39) 2.399
24	NOT TOOLED	70066-0373	(58.42) 2.300	(60.93) 2.399
25	NOT TOOLED	70066-0374	(60.96) 2.400	(63.47) 2.499

NOTES:

1. MATERIAL GLASS FILLED POLYESTER, UL94V-0; COLOR: BLACK.
2. HOUSING MAY BE USED WITH TERMINAL NUMBERS 70058, 71851, AND 70021.
3. REFER TO CHART FOR AVAILABLE CIRCUIT SIZES.
4. HOUSINGS TO BE USED WITH (0.64)/.025 SQUARE OR ROUND PINS.
5. REFER TO MOLEX PRODUCT SPECIFICATION(S): PS-70400, PS-70058, PS-71851, PS-70021, AND MOLEX APPLICATION SPECIFICATION SDES-70400.
6. DIMENSIONS ARE SHOWN FOR REFERENCE ONLY.
7. PACKAGE PER PK-70066-100.

ADD PS-70400 EC NO: UCP2012-1540 DRW:DMORGAN 2011/11/14 CHK:MMIBARRA 2011/11/14 APPR:SMILLER 2012/02/13	QUALITY SYMBOLS ∇=0 ∇=0 ∇=0	GENERAL TOLERANCES (UNLESS SPECIFIED)		DIMENSION STYLE MM/IN	SCALE 4:1	DESIGN UNITS INCH	THIRD ANGLE PROJECTION	
		4 PLACES ± --- ± ---	3 PLACES ± --- ± .010	DRAWN BY DMORGAN	DATE 2011/11/14	HOUSING-CONNECTOR W/POLARIZATION SLOTS & RIBS (2.54)/.100 GRID MOLEX MOLEX INCORPORATED		
		2 PLACES ± 0.25 ± .015	1 PLACE ± 0.38 ± ---	CHECKED BY SMR	DATE 1993/10/12			
		ANGULAR ± 1/2°		APPROVED BY SMILLER		DATE 2012/02/13	DOCUMENT NO. SD-70066-0351-0374	SHEET NO. 1 OF 1
DRAFT WHERE APPLICABLE MUST REMAIN WITHIN DIMENSIONS				MATERIAL NO. SEE CHART	THIS DRAWING CONTAINS INFORMATION THAT IS PROPRIETARY TO MOLEX INCORPORATED AND SHOULD NOT BE USED WITHOUT WRITTEN PERMISSION			