

REV	ECN.NO:	B Y	DATE
A7	△ EG-H13092	BENDEE	09/01/21
A8	△ EG-N1013111	Jody	10/06/08

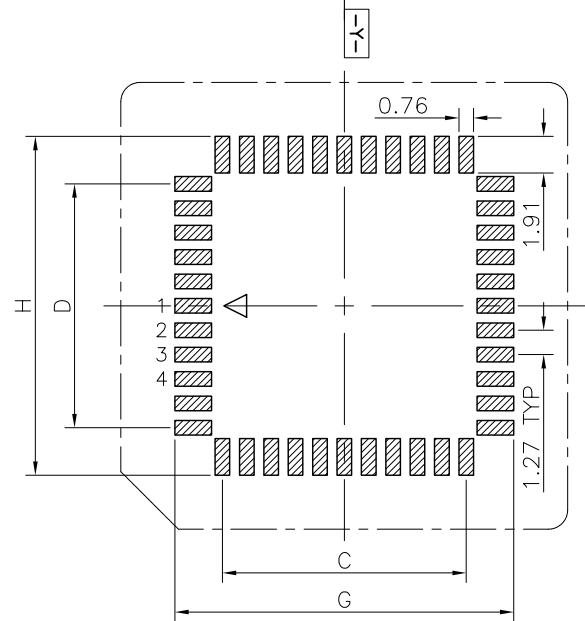

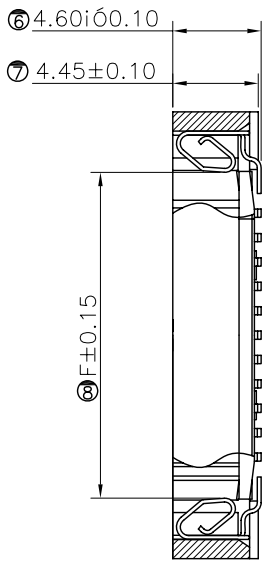

RECOMMENDED P.C BOARD LAYOUT

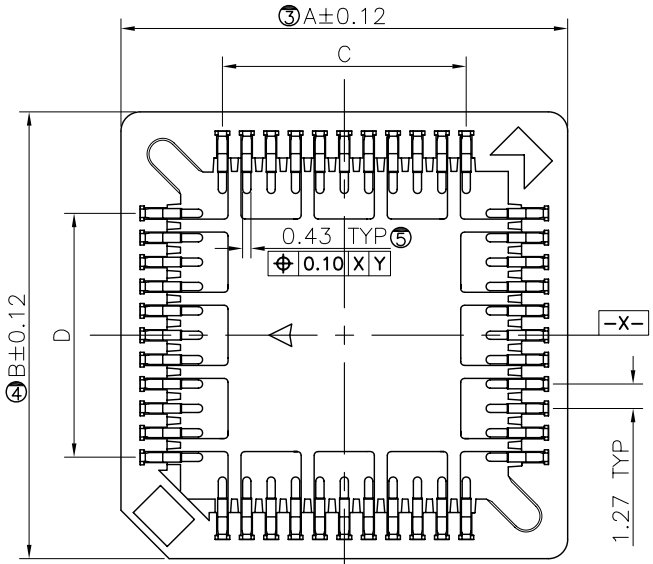
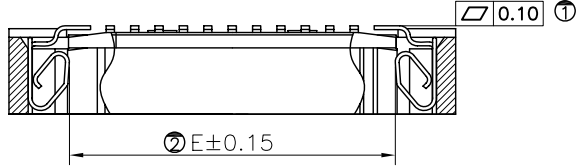
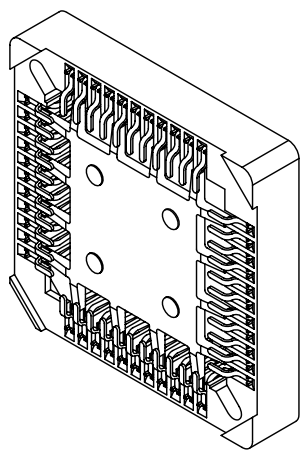

NOTES:
 SPECIFICATIONS:
 CURRENT RATING:1 AMP.
 VOLTAGE:250V AC/DC MAX.
 DIELECTRIC WITHSTANDING:500VAC FOR ONE MINUTE.
 CONTACT RESISTANCE:30mΩ (MAX).
 INSULATION RESISTANCE:1000MΩ (MIN).
 OPERATING TEMPERATURE:-55°C+105°C.
 RETENTION FORCE:0.30KG PER PIN (MIN).
 MATERIALS:
 INSULATOR: PPS +30%GF UL 94V-0.
 CONTACTS:PHOSOR BRONZE.
 CONTACT PLATING TIN.
 ○ MARK IS MAJOR TEXT DIMENSION.

Dimension No. OF Pin (mm)	A	B	C	D	E	F	G	H
SMT-28P	18.19	18.19	7.62	7.62	11.89	11.89	12.57	12.57
SMT-32P	20.73	18.19	10.16	7.62	14.35	11.85	13.56	12.80
SMT-44P	23.27	23.27	12.70	12.70	16.97	16.97	17.65	17.65
SMT-52P	25.81	25.81	15.24	15.24	19.51	19.51	20.19	20.19
SMT-68P	30.89	30.89	20.32	20.32	24.59	24.59	25.27	25.27
SMT-84P	35.97	35.97	25.40	25.40	29.67	29.67	30.35	30.35

-TOLERANCES- UNLESS OTHERWISE SPECIFIED		 		TITLE: PLCC 0.20 SMT 成品				
				APPD:		PRODUCT NO: 232-XX		
X.X ±0.30	X.X° ±3.0°	CHECK:		DATE	SCALE	UNIT	TYPE	PAGE
X.XX ±0.15	X.XX° ±1.00°	DRAW:		2010.06.08	FREE	MM	CD	1
X.XXX ±0.100	X.XXX° ±0.500°							