

CONNECTORS WITHOUT BRIDGE OPTION

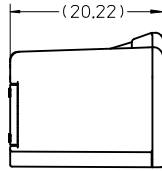

TPS SHOWN IN FULLY SEATED POSITION

SCOOP PROOF RIBS FOR CIRCUIT SIZES 14 THROUGH 20 ONLY

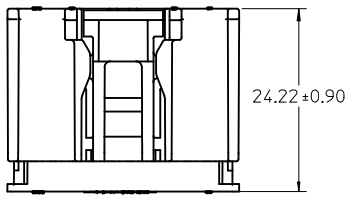
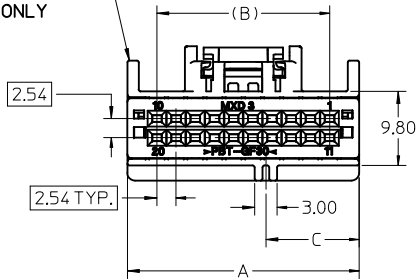

20 CIRCUIT HARNESS ASSEMBLY SHOWN

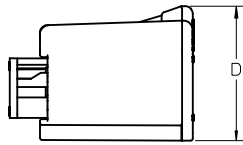

WITH TPA IN PRE-LOAD (AS SHIPPED)

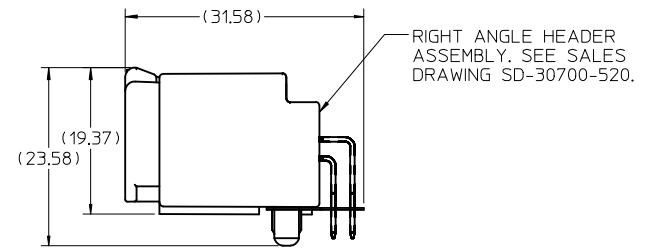
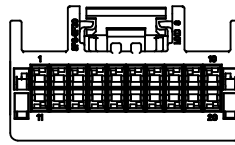

MATED VIEW

RIGHT ANGLE HEADER ASSEMBLY. SEE SALES DRAWING SD-30700-520.

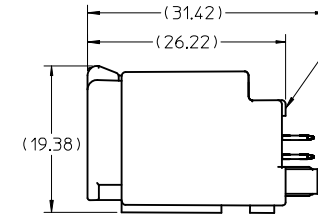

MATED VIEW

VERTICAL HEADER ASSEMBLY. SEE SALES DRAWING SD-30700-420.

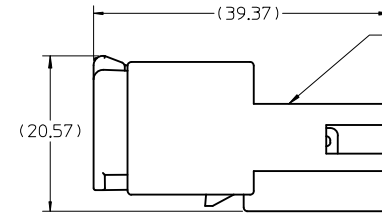

MATED VIEW

MALE INLINE HARNESS ASSEMBLY. SEE SALES DRAWING SD-30968-120.

CONNECTORS WITH BRIDGE OPTION

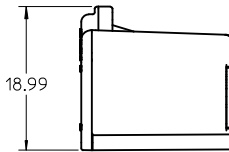
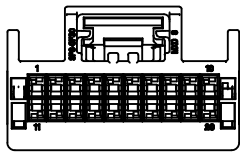

20 CIRCUIT HARNESS ASSEMBLY SHOWN

NOTES:

1. MATERIAL: HOUSING: SPS, GLASS FILLED, COLOR: SEE CHART. TPA: PBT, GLASS FILLED, COLOR: RED.
2. PRODUCT SPECIFICATION: PS-30700-0001
3. PACKAGING SPECIFICATION: PK-30907-417
4. MATES WITH: SERIES 30700 & 30968, SEE SALES DRAWINGS SD-30700-520, SD-30700-420 & SD-30968-120.

EC NO: UAU2013-1288 DRWN: JFISCHERO 2013/02/13 CHKD: APPR: RBAUMAN 2013/02/15 REV	QUALITY SYMBOLS	GENERAL TOLERANCES (UNLESS SPECIFIED)		SCALE 2:1	DESIGN UNITS METRIC	THIRD ANGLE PROJECTION	REVISE ON CAD ONLY
	▼ -0 ∇ -0		mm	INCH	DIMENSION STYLE MM ONLY		TITLE
		4 PLACES	± ---	± ---	DRAWN BY RCARLSON	DATE 01/03/23	
		3 PLACES	± ---	± ---	CHECKED BY CKRISHNA	DATE 01/03/27	
2 PLACES	± 0.13	± ---	APPROVED BY LGIEIB	DATE 01/03/28	MATERIAL NO. SEE CHART DOCUMENT NO. SD-30700-120 SHEET NO. 1 OF 3		
	1 PLACE	± 0.25	± ---	DRAFT WHERE APPLICABLE		THIS DRAWING CONTAINS INFORMATION THAT IS PROPRIETARY TO MOLEX INCORPORATED AND SHOULD NOT BE USED WITHOUT WRITTEN PERMISSION	
				ANGULAR ±1/2°			
				MUST REMAIN WITHIN DIMENSIONS			

ASSEMBLY PART NUMBER		POLARIZATION OPTIONS & CIRCUIT SIZE		PRODUCT DIMENSIONS					PASS THRU HOLE DIA FOR HARNESS	MATING INTERFACE DIMENSIONS	
WITHOUT BRIDGE	WITH BRIDGE	HARNESS ASSEMBLY (POLARIZATION OPTIONS)	CIRCUIT SIZE	A REF.	(B)	C	D	HOUSING COLOR		E	F
30700-1207	31389-1207	POLARIZATION OPTION #1	20	30.69	22.86	12.35	17.79	GRAY	36.5	12.57	31.14
30700-1208	31389-1208	POLARIZATION OPTION #2	20	30.69	22.86	15.35	17.79	BLACK	36.5	15.57	31.14
30700-1209	31389-1209	POLARIZATION OPTION #3	20	30.69	22.86	18.35	17.79	NATURAL (CREAM)	36.5	18.57	31.14
30700-1187	31389-1187	POLARIZATION OPTION #1	18	28.15	20.32	11.08	17.79	GRAY	34.0	11.31	28.60
30700-1188	31389-1188	POLARIZATION OPTION #2	18	28.15	20.32	14.08	17.79	BLACK	34.0	14.31	28.60
30700-1189	31389-1189	POLARIZATION OPTION #3	18	28.15	20.32	17.08	17.79	NATURAL (CREAM)	34.0	17.31	28.60
30700-1167	31389-1167	POLARIZATION OPTION #1	16	25.61	17.78	9.81	17.79	GRAY	32.0	10.04	26.06
30700-1168	31389-1168	POLARIZATION OPTION #2	16	25.61	17.78	12.81	17.79	BLACK	32.0	13.04	26.06
30700-1169	31389-1169	POLARIZATION OPTION #3	16	25.61	17.78	15.81	17.79	NATURAL (CREAM)	32.0	16.04	26.06
30700-1147	31389-1147	POLARIZATION OPTION #1	14	23.07	15.24	8.54	17.79	GRAY	30.0	8.77	23.52
30700-1148	31389-1148	POLARIZATION OPTION #2	14	23.07	15.24	11.54	17.79	BLACK	30.0	11.77	23.52
30700-1149	31389-1149	POLARIZATION OPTION #3	14	23.07	15.24	14.54	17.79	NATURAL (CREAM)	30.0	14.77	23.52
30700-1120	31389-1120	POLARIZATION OPTION #1	12	20.53	12.70	7.25	17.79	GRAY	27.5	7.50	20.98
30700-1121	31389-1121	POLARIZATION OPTION #2	12	20.53	12.70	10.27	17.79	BLACK	27.5	10.50	20.98
30700-1122	31389-1122	POLARIZATION OPTION #3	12	20.53	12.70	13.27	17.98	NATURAL (CREAM)	27.5	13.50	20.98
30700-1100	31389-1100	POLARIZATION OPTION #1	10	17.99	10.16	6.00	17.98	GRAY	26.4	6.23	18.44
30700-1101	31389-1101	POLARIZATION OPTION #2	10	17.99	10.16	9.00	17.98	BLACK	26.4	9.23	18.44
30700-1102	31389-1102	POLARIZATION OPTION #3	10	17.99	10.16	12.00	17.98	NATURAL (CREAM)	26.4	12.23	18.44
30700-1080	31389-1080	POLARIZATION OPTION #1	8	15.45	7.62	4.73	17.98	GRAY	25.5	4.96	15.90
30700-1081	31389-1081	POLARIZATION OPTION #2	8	15.45	7.62	7.73	17.98	BLACK	25.5	7.96	15.90
30700-1082	31389-1082	POLARIZATION OPTION #3	8	15.45	7.62	10.73	17.98	NATURAL (CREAM)	25.5	10.96	15.90
30700-1060	31389-1060	POLARIZATION OPTION #1	6	15.44	5.08	3.46	17.98	GRAY	25.5	3.69	13.36
30700-1061	31389-1061	POLARIZATION OPTION #2	6	15.44	5.08	6.46	17.98	BLACK	25.5	6.69	13.36
30700-1062	31389-1062	POLARIZATION OPTION #3	6	15.44	5.08	9.46	17.98	NATURAL (CREAM)	25.5	9.69	13.36

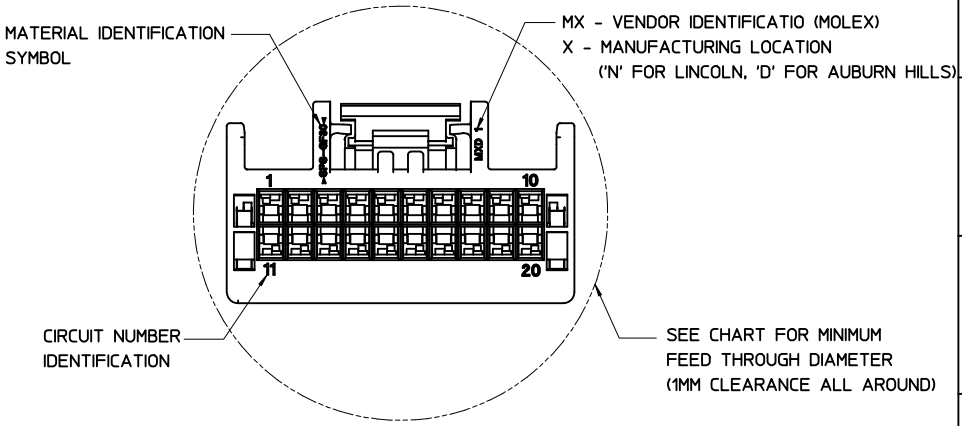
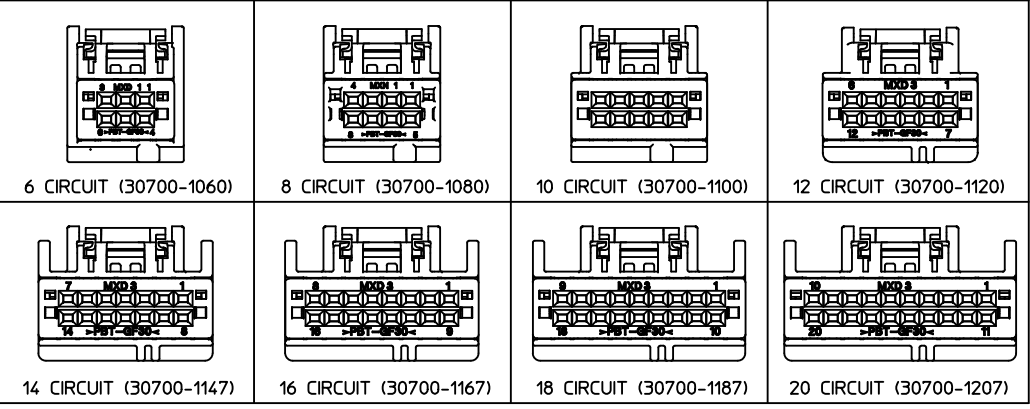
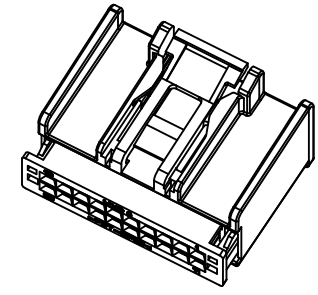

EC NO: UAU2013-1288 DRWN: FISCHERO 2013/02/13 CHKD: APPR: RBAUMAN 2013/02/15 REV	QUALITY SYMBOLS	GENERAL TOLERANCES (UNLESS SPECIFIED) DIMENSION STYLE MM ONLY	SCALE	DESIGN UNITS	THIRD ANGLE PROJECTION	REVISE ON CAD ONLY	
	▼ - 0 ∇ - 0		mm INCH 4 PLACES ± --- ± --- 3 PLACES ± --- ± --- 2 PLACES ± 0.13 ± --- 1 PLACE ± 0.25 ± --- ANGULAR ± 1/2°	2:1	METRIC	DIMENSION STYLE MM ONLY	TITLE
			DRAFT WHERE APPLICABLE	DRAWN BY	DATE	6-20 CIRCUIT HARNESS ASSEMBLY	
			MUST REMAIN WITHIN DIMENSIONS	CHECKED BY	DATE	MOLEX INCORPORATED	
			APPROVED BY	DATE	MATERIAL NO.	DOCUMENT NO.	
			LGEIB	01/03/28	SEE CHART	SD-30700-120	
			THIS DRAWING CONTAINS INFORMATION THAT IS PROPRIETARY TO MOLEX INCORPORATED AND SHOULD NOT BE USED WITHOUT WRITTEN PERMISSION		SHEET NO.		
					2 OF 3		

MATING INTERFACE DIMENSIONS (REFERENCE ONLY)

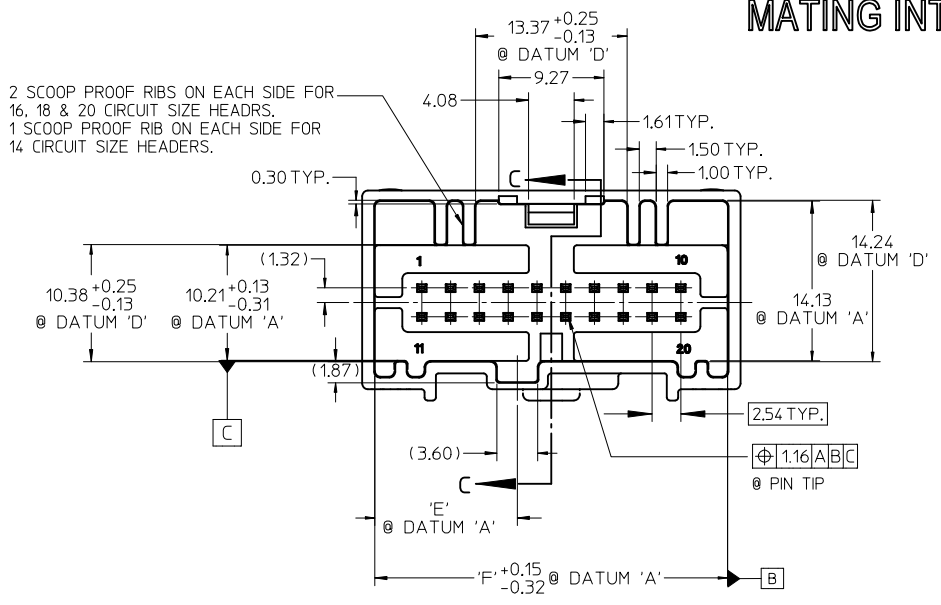

ABOVE VIEW APPLY TO 14, 16, 18 & 20 CIRCUIT ONLY

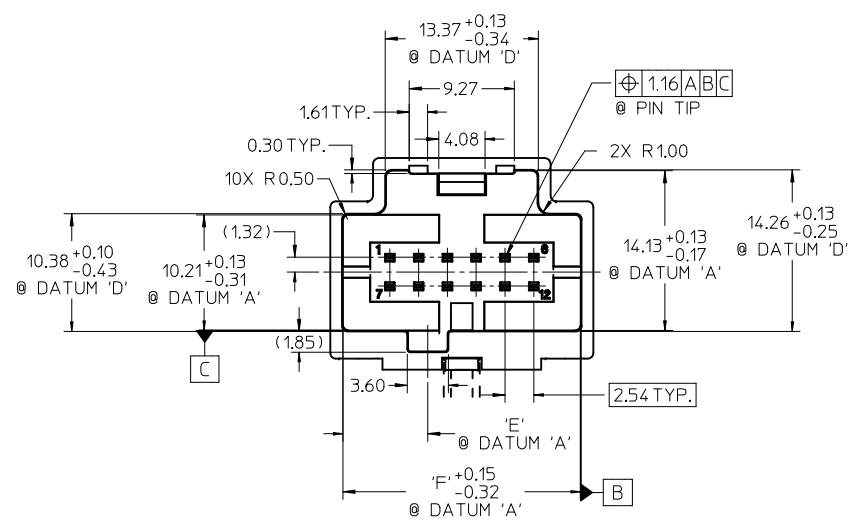

ABOVE VIEW APPLY TO 6, 8, 10 & 12 CIRCUIT ONLY

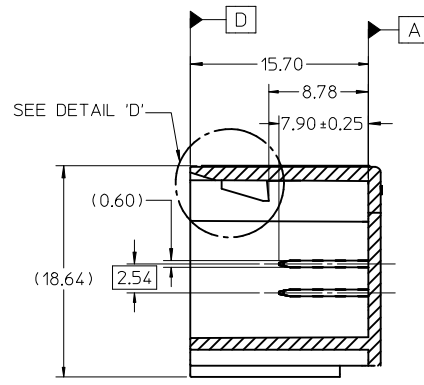
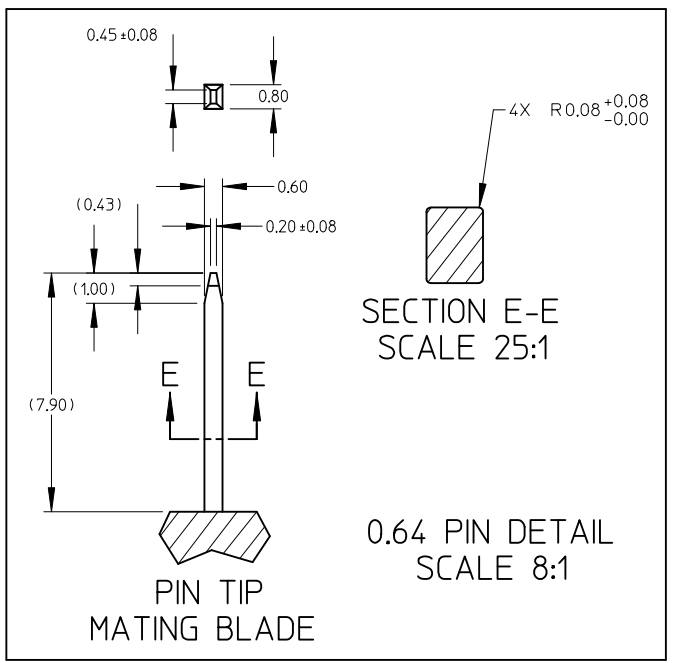

SECTION C-C

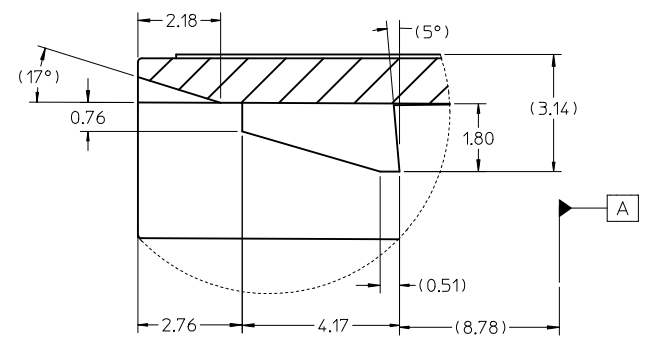

DETAIL 'D'
SCALE 10:1

EC NO: UAU2013-1288 DRWN: JFISCHER 01/03/13 CHK: RBAUMAN APPR: MKNACK 2013/02/15	QUALITY SYMBOLS	GENERAL TOLERANCES (UNLESS SPECIFIED)		SCALE	DESIGN UNITS	THIRD ANGLE PROJECTION	REVISE ON CAD ONLY	
	-0 ∇ 0		mm	INCH	DIMENSION STYLE		6-20 CIRCUIT HARNESS ASSEMBLY	
		4 PLACES ±	---	±	MM ONLY			
		3 PLACES ±	---	±	DRAWN BY	DATE	MOLEX INCORPORATED MATERIAL NO. SD-30700-120	
2 PLACES ±	0.13	±	RCARLSON	01/03/23				
1 PLACE ±	0.25	±	CHECKED BY	DATE	SHEET NO. 3 OF 3			
ANGULAR ± 1/2 °			CKRISHNA	01/03/27				
DRAFT WHERE APPLICABLE MUST REMAIN WITHIN DIMENSIONS		APPROVED BY	DATE	MATERIAL NO.	DOCUMENT NO.			
		LGEIB	01/03/28		SD-30700-120			
THIS DRAWING CONTAINS INFORMATION THAT IS PROPRIETARY TO MOLEX INCORPORATED AND SHOULD NOT BE USED WITHOUT WRITTEN PERMISSION								C