

NOTES: VALID UNLESS OTHERWISE SPECIFIED

1. GENERAL:
  - a. APPLICATION SPECIFICATION SEE: AS-34791-020
  - b. PRODUCT SPECIFICATION SEE: PS-34971-020
  - c. PACKAGING SPECIFICATION PER MOLEX DRAWING: PK-31301-538
  - d. PARTS MUST BE IN COMPLIANCE TO MOLEX CHEMICAL SUBSTANCES FOR PRODUCTS AND PACKAGING SPECIFICATION: PS-40000-5015
  - e. DATA MUST BE SUBMITTED UNDER THE MOLEX PART NUMBER TO IMDS (COMPANY ID#19255)
  - f. FLAMMABILITY REQUIREMENT: PER ISO3795 OR GM3191
    1. BURN RATE 100 mm/MIN MAXIMUM
    2. MATERIAL MUST BE SELF EXTINGUISHING
  - g. VISUAL DEFECTS SHALL MEET COSMETIC STANDARD PS-45499-002 (Class B)
  - h. FOR TERMINAL USAGE, REFER TO MOLEX SALES DRAWING SD-560023-002.
2. DESIGN - MATERIALS:
  - a. MATERIAL: UNFILLED PBT
3. DESIGN - GEOMETRY:
  - a. THIS IS A 100% CAD GENERATED PART. THE CAD MATHEMATICAL DATA IS THE MASTER FOR THIS PART. FOR DIMENSIONAL OR ANY INFORMATION NOT SHOWN ON THIS DRAWING, ANALYZE THE CAD MODEL.
  - b. GEOMETRIC DIMENSIONS AND TOLERANCES PER ASME Y14.5M - 1994
  - c. GENERAL TOLERANCES:
    - LINEAR: PER DIN 16901 CODE B FOR PRECISION ENGINEERING
    - ANGULAR:  $\pm 3^\circ$
  - d. EDGES AND UNDIMENSIONED DETAILS PER ISO13715
  - e. CORNERS SHOWN AS SHARP TO BE R 0.2 MAX
  - f. LETTERING SHALL BE 0.1 MAX RAISED IN 0.15 MAX RECESS PAD AND NOT PROTRUDE THE SURFACE. THIS INCLUDES RECYCLING CODE, PLANT AND CAVITY ID, VENDOR ID, CIRCUIT ID, AND PART SERIES NUMBER.
  - g. USCAR VERSION NOT TOOLED. PREVIOUS VERSIONS OF LISTED 4CKT AND 8CKT HEADERS ARE TOOLED. REFER TO SD-34792-001 REV B.

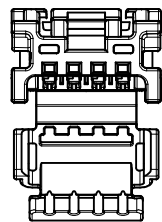

4 CIRCUIT RECEPTACLE  
POLARIZATION OPTION A

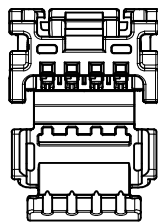

4 CIRCUIT RECEPTACLE  
POLARIZATION OPTION B

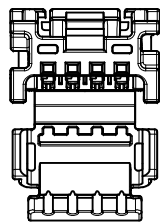

4 CIRCUIT RECEPTACLE  
POLARIZATION OPTION C

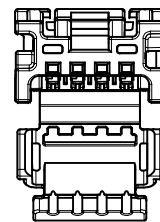

4 CIRCUIT RECEPTACLE  
POLARIZATION OPTION D

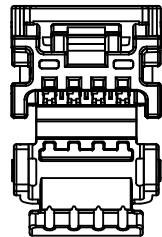

4 CIRCUIT RECEPTACLE BRIDGED  
POLARIZATION OPTION A

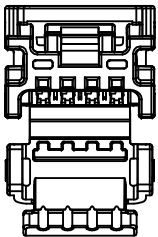

4 CIRCUIT RECEPTACLE BRIDGED  
POLARIZATION OPTION B

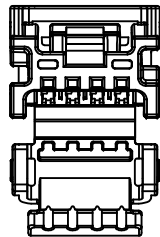

4 CIRCUIT RECEPTACLE BRIDGED  
POLARIZATION OPTION C

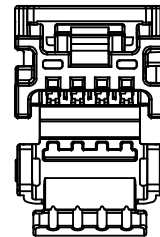

4 CIRCUIT RECEPTACLE BRIDGED  
POLARIZATION OPTION D

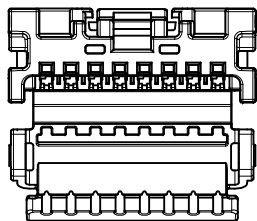

8 CIRCUIT RECEPTACLE  
POLARIZATION OPTION A

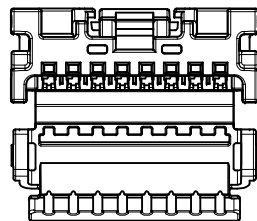

8 CIRCUIT RECEPTACLE  
POLARIZATION OPTION B

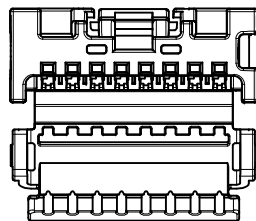

8 CIRCUIT RECEPTACLE  
POLARIZATION OPTION C

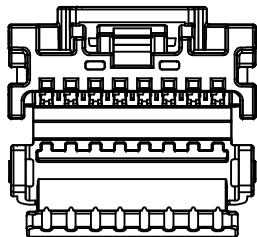

8 CIRCUIT RECEPTACLE BRIDGED  
POLARIZATION OPTION A

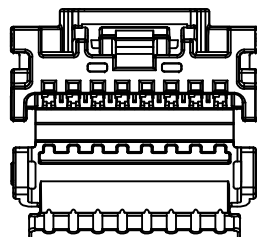

8 CIRCUIT RECEPTACLE BRIDGED  
POLARIZATION OPTION B

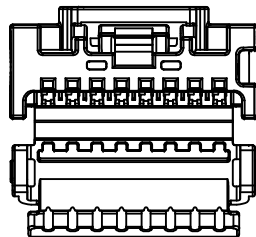

8 CIRCUIT RECEPTACLE BRIDGED  
POLARIZATION OPTION C

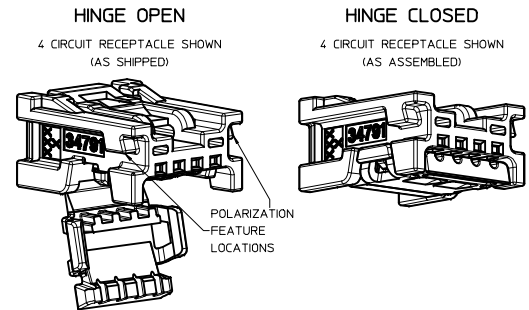

LAST BALLOON ON DRAWING:  
②  
DELETED BALLOONS:

USCAR UPDATES IEC NO. UAU2013-0532 DRAWN BY: JDUANJ CHYK: BDICK APPR: RBALMAN 2012/10/04 2010/06/24 2010/06/24 2011/11/21	QUALITY SYMBOLS ∇=0 ∇=0 ∇=0	GENERAL TOLERANCES (UNLESS SPECIFIED)		DIMENSION STYLE MM ONLY	SCALE 6:1	DESIGN UNITS METRIC	THIRD ANGLE PROJECTION		
		4 PLACES ±--- ±--- 3 PLACES ±--- ±--- 2 PLACES ±--- ±--- 1 PLACE ±--- ±---	mm    INCH	DRAWN BY: JDUANJ DATE: 2010/06/24	CHECKED BY: BDICK DATE: 2010/06/24	MINISO SINGLE ROW RECEPTACLE ASSEMBLY SALES DRAWING			
		ANGULAR ±----°	DRAFT WHERE APPLICABLE MUST REMAIN WITHIN DIMENSIONS	APPROVED BY: SMARCEAU DATE: 2011/11/21	MATERIAL NO. SEE TABLE SIZE D	DOCUMENT NO. SD-34791-001	MOLEX INCORPORATED	SHEET NO. 1 OF 3	

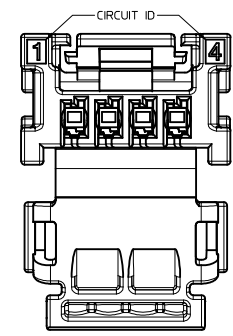
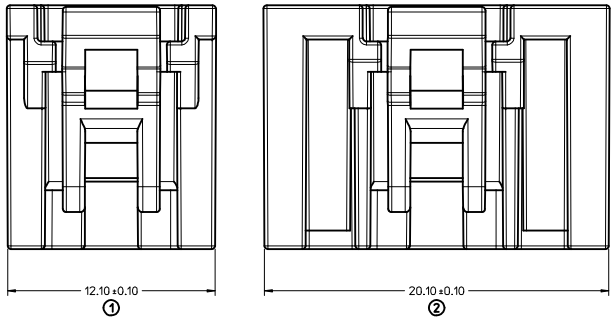
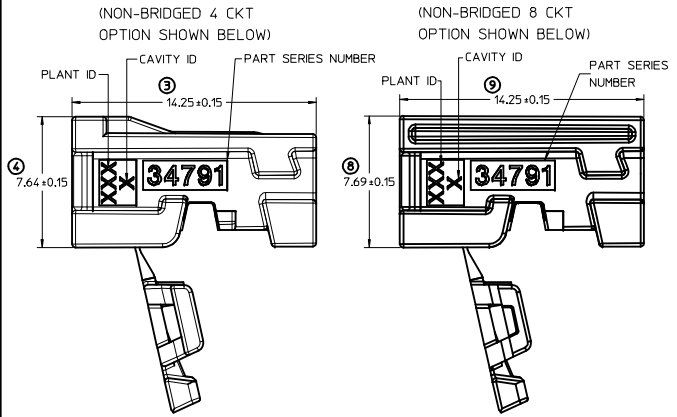

4 CKT RECEPTACLE SHOWN BELOW.  
8 CKT RECEPTACLE HAS SIMILAR  
CIRCUIT ID LOCATION.

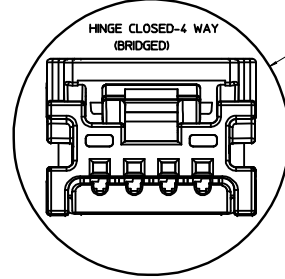
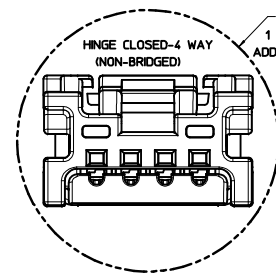
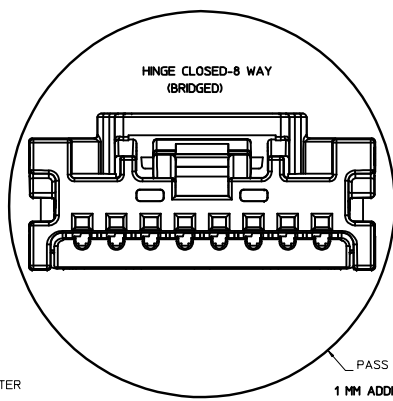
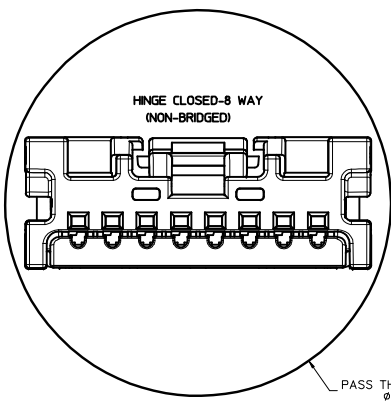
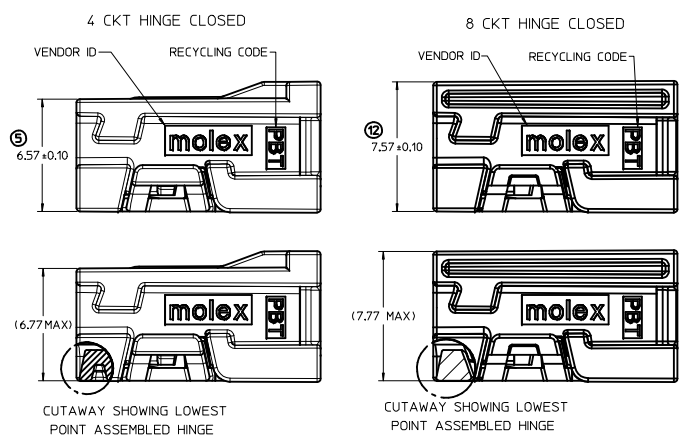
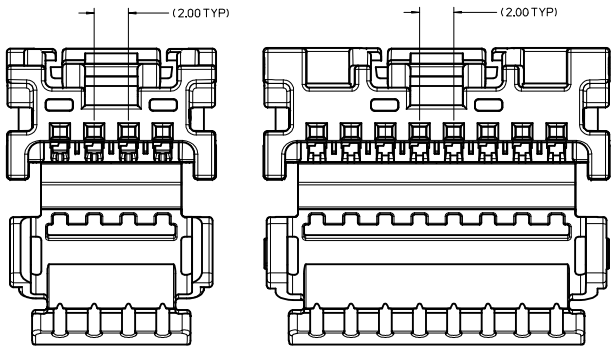
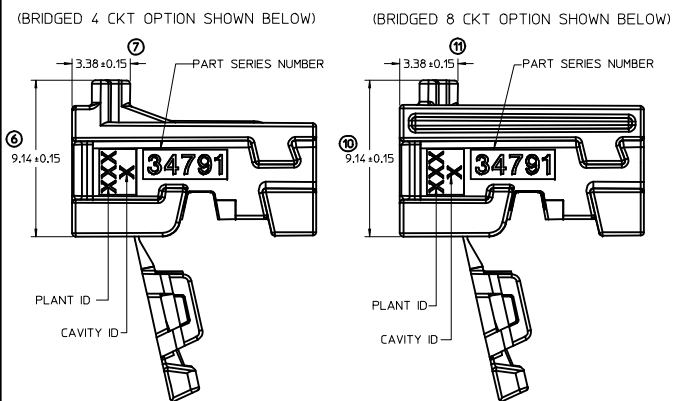

USCAR UPDATES EIC NO. UAU2013-0532 DRAWN BY: JDU CHKD: BDI APPR: RBALMAN 2012/10/04 2012/10/25	QUALITY SYMBOLS	GENERAL TOLERANCES (UNLESS SPECIFIED)	DIMENSION STYLE	SCALE	DESIGN UNITS	THIRD ANGLE PROJECTION
	∇=0 ∇=0 ∇=0	mm INCH 4 PLACES ± --- ± --- 3 PLACES ± --- ± --- 2 PLACES ± --- ± --- 1 PLACE ± --- ± --- ANGULAR ± ---°	MM ONLY	7:1	METRIC	TITLE: MINIS0 SINGLE ROW RECEPTACLE ASSEMBLY SALES DRAWING MOLEX INCORPORATED DOCUMENT NO. SD-34791-001
	DRAWN BY: JDU DATE: 2010/06/24 CHECKED BY: BDI DATE: 2010/06/24 APPROVED BY: SMARCEAU DATE: 2011/11/21	MATERIAL NO. SEE TABLE	SHEET NO. 2 OF 3			
	DRAFT WHERE APPLICABLE MUST REMAIN WITHIN DIMENSIONS			THIS DRAWING CONTAINS INFORMATION THAT IS PROPRIETARY TO MOLEX INCORPORATED AND SHOULD NOT BE USED WITHOUT WRITTEN PERMISSION		

MINI50 RECEPTACLE ASSEMBLIES

MATERIAL NUMBER BULK PACKAGING PK-31301-538	LOCK BRIDGE OPTION	CONFIGURATION	CIRCUIT	POL	COLOR	TOOLED	MATING COMPONENT								
							SURFACE MOUNT TECHNOLOGY (SMT) HEADER			VERTICAL THRU HOLE HEADER			RIGHT ANGLE THRU HOLE HEADERS		
							TAPE AND REEL PACKAGING PK-31301-786	TUBE PACKAGING PK-31301-688	TOOLED	TRAY PACKAGING PK-31301-440	TUBE PACKAGING PK-31301-688	TOOLED *SEE NOTE 3g.	TRAY PACKAGING PK-31301-440	TUBE PACKAGING PK-31301-688	TOOLED *SEE NOTE 3g.
34791-0040	NO	USCAR COMPATIBLE	4	A	BLACK	YES	34912-8040	34912-9040	YES	34792-0040	34792-9040	NO	34793-0040	34793-9040	NO
34791-0041	NO	USCAR COMPATIBLE	4	B	GRAY	YES	34912-8041	34912-9041	YES	34792-0041	34792-9041	NO	34793-0041	34793-9041	NO
34791-0042	NO	USCAR COMPATIBLE	4	C	BROWN	YES	34912-8042	34912-9042	YES	34792-0042	34792-9042	NO	34793-0042	34793-9042	NO
34791-0043	NO	USCAR COMPATIBLE	4	D	GREEN	YES	34912-8043	34912-9043	YES	34792-0043	34792-9043	NO	34793-0043	34793-9043	NO
34791-0080	NO	USCAR COMPATIBLE	8	A	BLACK	NO	34912-8080	34912-9080	NO	34792-0080	34792-9080	NO	34793-0080	34793-9080	NO
34791-0081	NO	USCAR COMPATIBLE	8	B	GRAY	NO	34912-8081	34912-9081	NO	34792-0081	34792-9081	NO	34793-0081	34793-9081	NO
34791-0082	NO	USCAR COMPATIBLE	8	C	BROWN	NO	34912-8082	34912-9082	NO	34792-0082	34792-9082	NO	34793-0082	34793-9082	NO
34791-0140	YES	USCAR COMPATIBLE	4	A	BLACK	NO	34912-8040	34912-9040	YES	34792-0040	34792-9040	NO	34793-0040	34793-9040	NO
34791-0141	YES	USCAR COMPATIBLE	4	B	GRAY	NO	34912-8041	34912-9041	YES	34792-0041	34792-9041	NO	34793-0041	34793-9041	NO
34791-0142	YES	USCAR COMPATIBLE	4	C	BROWN	NO	34912-8042	34912-9042	YES	34792-0042	34792-9042	NO	34793-0042	34793-9042	NO
34791-0143	YES	USCAR COMPATIBLE	4	D	GREEN	NO	34912-8043	34912-9043	YES	34792-0043	34792-9043	NO	34793-0043	34793-9043	NO
34791-0180	YES	USCAR COMPATIBLE	8	A	BLACK	NO	34912-8080	34912-9080	NO	34792-0080	34792-9080	NO	34793-0080	34793-9080	NO
34791-0181	YES	USCAR COMPATIBLE	8	B	GRAY	NO	34912-8081	34912-9081	NO	34792-0081	34792-9081	NO	34793-0081	34793-9081	NO
34791-0182	YES	USCAR COMPATIBLE	8	C	BROWN	NO	34912-8082	34912-082	NO	34792-0082	34792-9082	NO	34793-0082	34793-9082	NO

CTX50 UNSEALED RECEPTACLE TERMINALS

PART NUMBER		MATERIAL	WIRE GAGE (mm <sup>2</sup> )	GRIP
D-WIND (LEFT PAYOFF)	B-WIND (RIGHT PAYOFF)			
560023-0421	560023-0423	COPPER ALLOY	0.22 - 0.35	MEDIUM
560023-0422	560023-0424	COPPER ALLOY	0.08 - 0.13	SMALL

<b>USCAR UPDATES</b> IEC NO. UAU2013-0532 DRAWN BY: YOUNG01 2012/10/04 CHKD: APPR: RBALMAN 2012/10/29 REV:	QUALITY SYMBOLS	GENERAL TOLERANCES (UNLESS SPECIFIED)	DIMENSION STYLE	SCALE	DESIGN UNITS	THIRD ANGLE PROJECTION
	▽=0	4 PLACES ±	MM ONLY	5:1	METRIC	☉
	▽=0	3 PLACES ±				
	▽=0	2 PLACES ±				
		1 PLACE ±				
		0 PLACE ±				
		ANGULAR ±				
		DRAFT WHERE APPLICABLE MUST REMAIN WITHIN DIMENSIONS				
			DRAWN BY: JDUNAJ	DATE: 2010/06/24	TITLE: MINI50 SINGLE ROW RECEPTACLE ASSEMBLY SALES DRAWING	
			CHECKED BY: BDLCK	DATE: 2010/06/24	MOLEX INCORPORATED	
			APPROVED BY: SMARCEAU	DATE: 2011/11/21	MATERIAL NO. SD-34791-001	
					DOCUMENT NO. 3 OF 3	
					SHEET NO. 3 OF 3	
					THIS DRAWING CONTAINS INFORMATION THAT IS PROPRIETARY TO MOLEX INCORPORATED AND SHOULD NOT BE USED WITHOUT WRITTEN PERMISSION	