

REF -50 OPTION SCREW
(WHERE APPLICABLE)

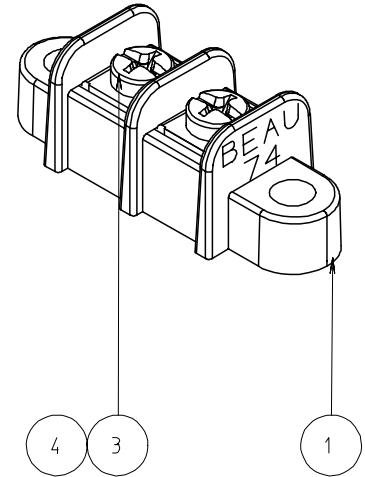
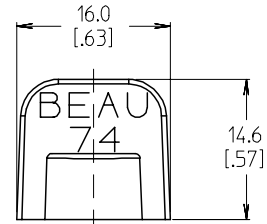

NOTES:

1. MATERIAL: SEE TABLE
2. INCH DIMENSIONS ARE SHOWN IN BRACKETS [XXX].
3. "XX" REFERS TO THE NUMBER OF CIRCUITS
4. ALL COMPONENTS ARE ROHS COMPLIANT.

ITEM	QTY	DESCRIPTION	MATERIAL	FINISH
5	"XX"	SCREW #6-32X.250 PAN HD W/WSHR (-50 OPTION)	STEEL	ZINC, CLEAR CHROMATE
4	"XX"	SCREW #6-32X.250 BDG HD (-49 OPTION)	BRASS	NICKEL
3	"XX"	SCREW #6-32X.250 BDG HD (STANDARD)	STEEL	ZINC, CLEAR CHROMATE
2	"XX"	TERMINAL, CB 6C SN/B	BRASS	TIN
1	1	SR BTS INSULATOR MO MTG	THERMOPLASTIC	BLACK

INITIAL RELEASE
EC NO: ETC2007-0010
DRW: NEHLE 2006/08/07
CHKD: JMACNEIL 2006/08/08
APPR: RDEROSS 2006/08/09

QUALITY SYMBOLS
 = 0
 = 0

	GENERAL TOLERANCES (UNLESS SPECIFIED)	
	mm	INCH
4 PLACES	± .005	± .0005
3 PLACES	± .013	± .001
2 PLACES	± 0.3	± .012
1 PLACE	± 0.3	± .012
ANGULAR ± 2 °		

DIMENSION STYLE	
MM/IN	SCALE
DRAWN BY: EHILE	DATE: 2006/07/06
CHECKED BY: JMACNEIL	DATE: 2006/07/06
APPROVED BY: RDEROSS	DATE: 2006/07/06
MATERIAL NO. SEE CHART	DOCUMENT NO. SD-38740-003

SCALE	DESIGN UNITS	THIRD ANGLE PROJECTION
2:1	INCH	
TITLE: 11.11MM [.438] SR BTS CB ASSY, W/ MTG		
MOLEX INCORPORATED		
SHEET NO. 1 OF 2		

# OF CIRCUITS "XX"	DIM. "A"		DIM. "B"		DIM. "C"		ASSEMBLY MATERIAL NO. (STANDARD)	ASSEMBLY MATERIAL NO. (-49 OPT)	ASSEMBLY MATERIAL NO. (-50 OPT)
	mm	in	mm	in	mm	in			
02	43.5	1.71	11.11	0.438	33.34	1.313	387400102	387400702	387401302
03	54.6	2.15	22.23	0.875	44.45	1.750	387400103	387400703	387401303
04	65.7	2.59	33.34	1.313	55.56	2.188	387400104	387400704	387401304
05	76.8	3.03	44.45	1.750	66.68	2.625	387400105	387400705	387401305
06	87.9	3.46	55.56	2.188	77.79	3.063	387400106	387400706	387401306
07	99.1	3.90	66.68	2.625	88.90	3.500	387400107	387400707	387401307
08	110.2	4.34	77.79	3.063	100.01	3.938	387400108	387400708	387401308
09	121.3	4.78	88.90	3.500	111.13	4.375	387400109	387400709	387401309
10	132.4	5.21	100.01	3.938	122.24	4.813	387400110	387400710	387401310
11	143.5	5.65	111.13	4.375	133.35	5.250	387400111	387400711	387401311
12	154.6	6.09	122.24	4.813	144.46	5.688	387400112	387400712	387401312
13	165.7	6.53	133.35	5.250	155.58	6.125	387400113	387400713	387401313
14	176.8	6.96	144.46	5.688	166.69	6.563	387400114	387400714	387401314
15	188.0	7.40	155.58	6.125	177.80	7.000	387400115	387400715	387401315
16	199.1	7.84	166.69	6.563	188.91	7.438	387400116	387400716	387401316
17	210.2	8.28	177.80	7.000	200.03	7.875	387400117	387400717	387401317
18	221.3	8.71	188.91	7.438	211.14	8.313	387400118	387400718	387401318
19	232.4	9.15	200.03	7.875	222.25	8.750	387400119	387400719	387401319
20	243.5	9.59	211.14	8.313	233.36	9.188	387400120	387400720	387401320
21	254.6	10.03	222.25	8.750	244.48	9.625	387400121	387400721	387401321
22	265.7	10.46	233.36	9.188	255.59	10.063	387400122	387400722	387401322
23	276.9	10.90	244.48	9.625	266.70	10.500	387400123	387400723	387401323
24	288.0	11.34	255.59	10.063	277.81	10.938	387400124	387400724	387401324
25	299.1	11.78	266.70	10.500	288.93	11.375	387400125	387400725	387401325
26	310.2	12.21	277.81	10.938	300.04	11.813	387400126	387400726	387401326
27	321.3	12.65	288.93	11.375	311.15	12.250	387400127	387400727	387401327
28	332.4	13.09	300.04	11.813	322.26	12.688	387400128	387400728	387401328
29	343.5	13.53	311.15	12.250	333.38	13.125	387400129	387400729	387401329
30	354.6	13.96	322.26	12.688	344.49	13.563	387400130	387400730	387401330

INITIAL RELEASE EC NO: ETC2007-0010 DRW: NEHLE 2006/08/07 CHKD: JMACNEIL 2006/08/08 APPR: RDEROSS 2006/08/09	DESCRIPTION A	QUALITY SYMBOLS ▽=0 ▽=0	GENERAL TOLERANCES (UNLESS SPECIFIED) mm INCH 4 PLACES ± --- ± --- 3 PLACES ± --- ± .005 2 PLACES ± 0.13 ± .01 1 PLACE ± 0.3 ± --- ANGULAR ± 2 °	DIMENSION STYLE MM/IN DRAWN BY DATE EHILE 2006/07/06 CHECKED BY DATE JMACNEIL 2006/07/06 APPROVED BY DATE RDEROSS 2006/07/06	SCALE 2:1 DESIGN UNITS INCH THIRD ANGLE PROJECTION	TITLE 11.11MM [.438] SR BTS CB ASSY, W/ MTG
		DRAFT WHERE APPLICABLE MUST REMAIN WITHIN DIMENSIONS	MATERIAL NO. SEE CHART	DOCUMENT NO. SD-38740-003	SHEET NO. 2 OF 2	
		SIZE B	THIS DRAWING CONTAINS INFORMATION THAT IS PROPRIETARY TO MOLEX INCORPORATED AND SHOULD NOT BE USED WITHOUT WRITTEN PERMISSION			
		MOLEX INCORPORATED				