

RECOMMENDED PC BOARD LAYOUT & KEEP-OUT ZONE

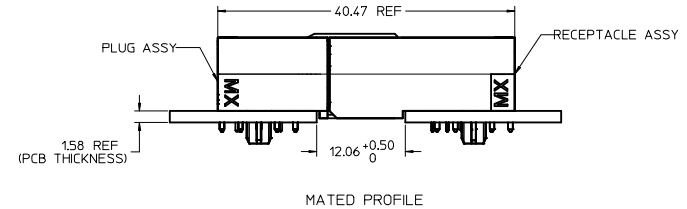

MATED PROFILE

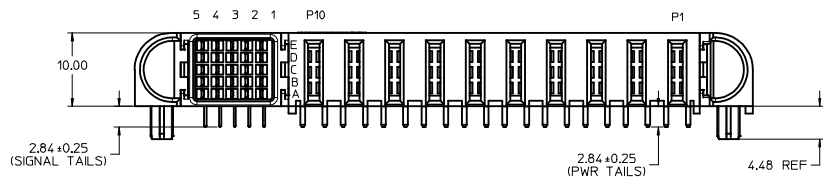
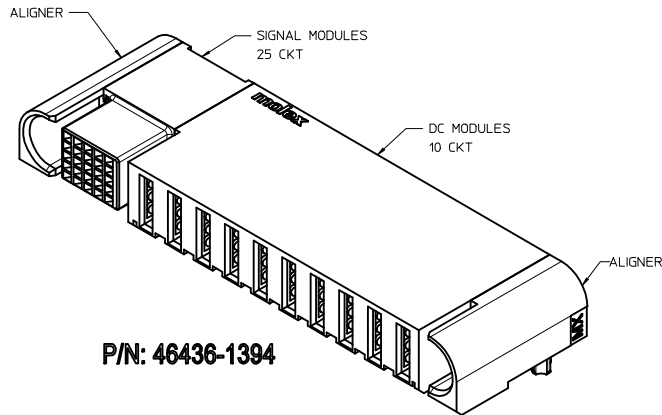

- NOTES:
- MATERIAL:
 - HOUSINGS: LCP UL94 V-0, COLOR: BLACK
 - TERMINALS: COPPER ALLOY
 - PLATING: 127 MICROMETER (50 MICROINCH) NICKEL OVERALL AND 0.762 MICROMETER (30 MICROINCH) SELECTIVE GOLD ON CONTACT AREA
 - PACKAGING: ASSEMBLIES TO BE TRAY PACKED PER PACKAGING SPEC: TBD
 - PLATED THRU HOLE SIZE, REFER TO PS-46436-100 FOR DETAILS
 - PRODUCT SPEC: PS-46436-100
 - APPLICATION SPEC: AS-46436-100
 - PRODUCT TO MEET RoHS REQUIREMENTS
 - ASSEMBLY MATES WITH PLUG ASSEMBLY P/N 46437-1394
 - TAIL DESIGN: SOLDER TAIL
 - POWER AND SIGNAL CONTACTS ARE LUBRICATED

INITIAL RELEASE IEC NO. UCP2013-1546 DRAWN BY: CHYK/JESSIECHUA APPR: SHONG 2012/10/23 2012/11/20	QUALITY SYMBOLS ▽=0 ▽=0 ▽=0	GENERAL TOLERANCES (UNLESS SPECIFIED) mm INCH		DIMENSION STYLE MM ONLY	SCALE 3:1	DESIGN UNITS METRIC	THIRD ANGLE PROJECTION
		4 PLACES ±--- ±--- 3 PLACES ±--- ±--- 2 PLACES ±0.25 ±--- 1 PLACE ±0.25 ±--- 0 PLACE ±--- ±---	DRAWN BY: KJKOH CHECKED BY: JESSIECHUA APPROVED BY: SHONG DATE: 2012/05/31 DATE: 2012/11/20	TITLE RA RECEPT ASSY G-10P-25S-G TEN60 POWER FAMILY		MATERIAL NO. 46436-1394	DOCUMENT NO. SD-46436-1394
DRAFT WHERE APPLICABLE MUST REMAIN WITHIN DIMENSIONS		THIS DRAWING CONTAINS INFORMATION THAT IS PROPRIETARY TO MOLEX INCORPORATED AND SHOULD NOT BE USED WITHOUT WRITTEN PERMISSION					

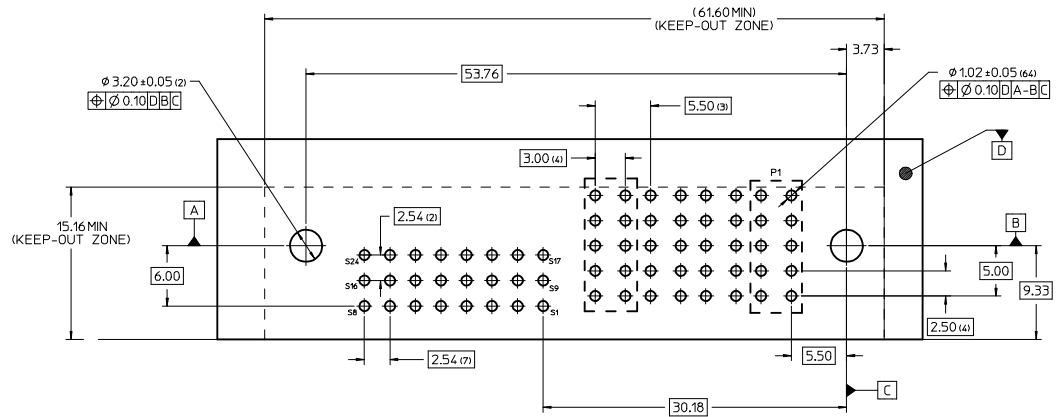
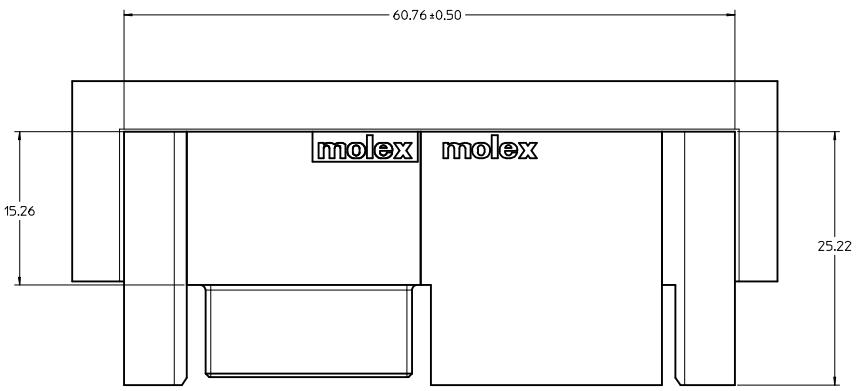

RECOMMENDED PC BOARD LAYOUT & KEEP-OUT ZONE

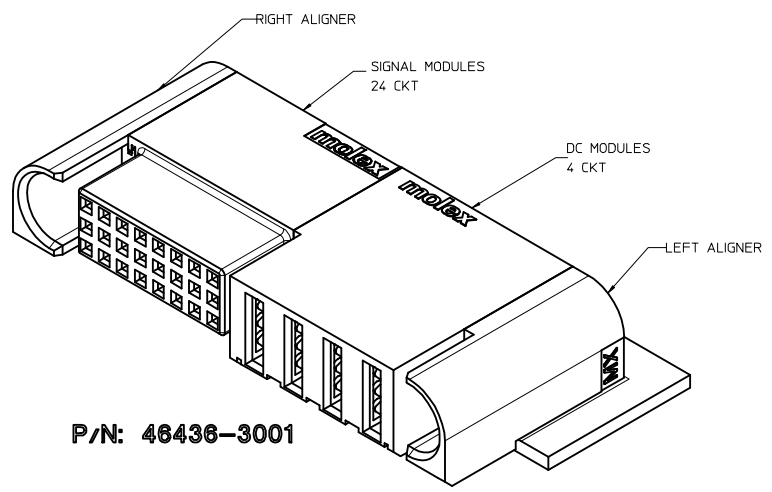
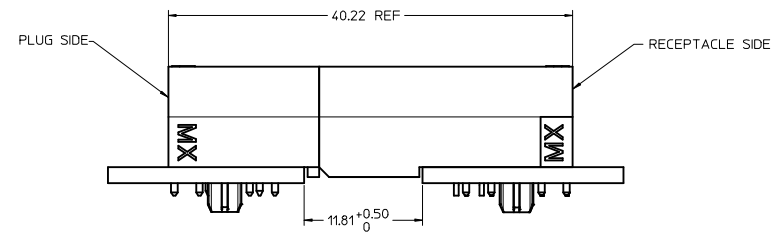
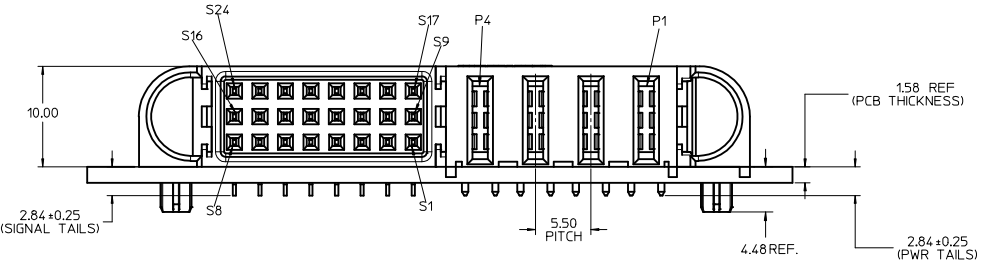

P/N: 46436-3001

NOTES:

1. MATERIAL:
 - HOUSINGS: LCP UL94, V-0, COLOR: BLACK.
 - TERMINALS: COPPER ALLOY.
 - PLATING: 0.00127 NICKEL OVERALL WITH 0.00254 SELECTIVE TIN ON SOLDER TAILS AND 0.000762 SELECTIVE GOLD ON CONTACT AREA.
2. ASSEMBLIES PACKED IN TRAYS, SPQ: TBD
3. PC BOARD REQUIRES SOLDER THRU HOLES, REFER TO PS-46436-100 FOR DETAILS
4. PRODUCT SPEC: PS-46436-100.
5. APPLICATION SPEC: AS-46436-100.
6. PRODUCT TO MEET ROHS REQUIREMENTS.
7. ASSEMBLY MATES TO MOLEX PLUG ASSEMBLY P/N 46437-3001.

RELEASED DEC NO: UCP2009-2546 DRWNG: JQULES CHKDR: JKOH APPR: PATEL 2009/05/05 2009/05/05 2009/05/05	QUALITY SYMBOLS DESCRIPTION	GENERAL TOLERANCES (UNLESS SPECIFIED)		DIMENSION STYLE		SCALE	DESIGN UNITS	THIRD ANGLE PROJECTION RA RECEPT ASSY TEN60 POWER, GUIDES G-4P-24S-G MOLEX INCORPORATED SD-46436-301	SHEET NO. 1 OF 1		
				MM ONLY		NTS	METRIC				
				DRAWN BY DATE		CHECKED BY DATE				APPROVED BY DATE	
				MATERIAL NO.		DOCUMENT NO.					
		4 PLACES ±.--- ±.---		DRAWN BY DATE							
		3 PLACES ±.--- ±.---		KJKOH 2009/03/11							
		2 PLACES ±.25 ±.---		CHECKED BY DATE							
		1 PLACE ±.25 ±.---		KJKOH 2009/03/11							
		ANGULAR ±1/2°		APPROVED BY DATE							
		DRAFT WHERE APPLICABLE MUST REMAIN WITHIN DIMENSIONS		SHONG							
				MATERIAL NO.							
				46436-3001							
				THIS DRAWING CONTAINS INFORMATION THAT IS PROPRIETARY TO MOLEX INCORPORATED AND SHOULD NOT BE USED WITHOUT WRITTEN PERMISSION							