

NOTE  
 1. 嵌合相手: 51382シリーズ  
 2. 偶数極 (列) に適用。  
 3. キングは両外側の位置に付加。  
 4. 製品番号 MATERIAL NO.

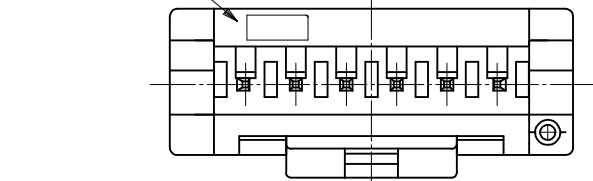
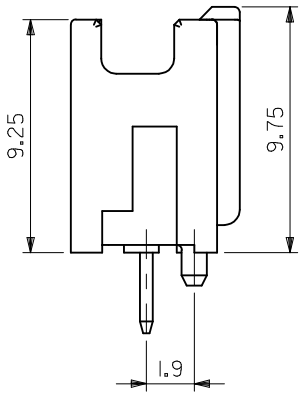
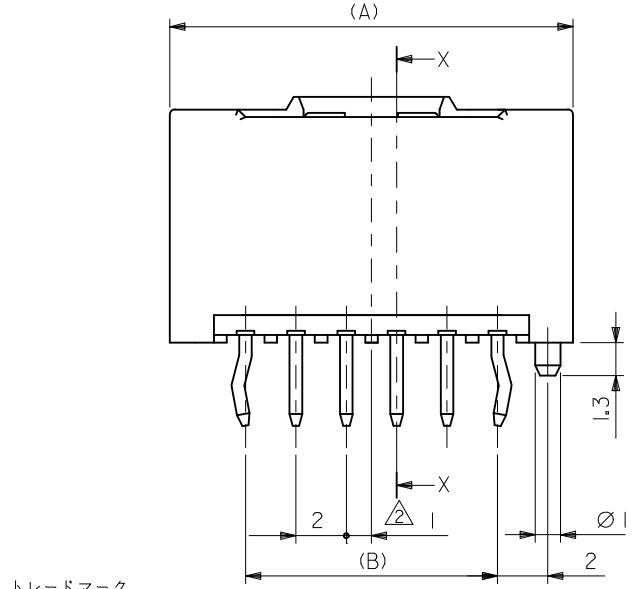
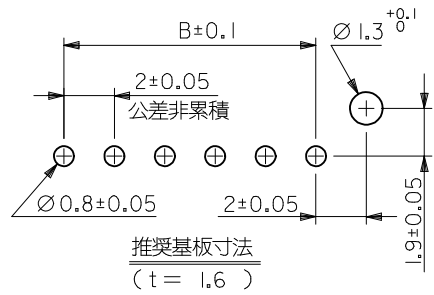

MATERIAL  
 ピン : 黄銅、錫メッキ  
 ハウジング : PBT

55932-\*\*\*\*  
 極数 CIRCUIT SIZE

色 COLOR
10 自然色 (白) NATURAL (WHITE)
11 黒 BLACK
12 赤 RED
13 黄 YELLOW
14 青 BLUE
15 桃 PINK
16 緑 GREEN
17 茶 BROWN
18 橙 ORANGE
19 紫 VIOLET
41 灰 GRAY
43 蛍光黄 FLUORESCENCE YELLOW
44 水 PALE BLUE
46 黄緑 YELLOWISH GREEN

31	28	34	55932-15**	15
29	26	32	55932-14**	14
27	24	30	55932-13**	13
25	22	28	55932-12**	12
23	20	26	55932-11**	11
21	18	24	55932-10**	10
19	16	22	55932-09**	9
17	14	20	55932-08**	8
15	12	18	55932-07**	7
13	10	16	55932-06**	6
11	8	14	55932-05**	5
9	6	12	55932-04**	4
7	4	10	55932-03**	3
5	2	8	55932-02**	2
C	B	A	MATERIAL NO. CKT.	

REVISED EC NO: J2014-0496 DRWN: YAJI MAO1 2013/09/18 CHKD: KASAKAWA 2013/09/19 APPR: NUKITA 2013/09/19	GENERAL TOLERANCES (UNLESS SPECIFIED)		DIMENSION STYLE MM ONLY		SCALE ---	DESIGN UNITS METRIC	THIRD ANGLE PROJECTION
	10 UNDER	±0.2	DRAWN BY T. NIITSU	DATE '02/02/08	TITLE 2.0 W/B SINGLE CONN. PLUG HOUSING ASS'Y ST -LEAD FREE-		
	10 OVER 30 UNDER	±0.25	CHECKED BY K. ASAKAWA	DATE '03/06/12	<b>molex</b> DOCUMENT NO. SD-55932-002 SHEET NO. 1 OF 2		
	30 OVER	±0.3	APPROVED BY T. YAMAGUCHI	DATE '03/06/12			
REV J	DESCRIPTION	ANGULAR ±3 °	MATERIAL NO.		SEE CHART		
DRAFT WHERE APPLICABLE MUST REMAIN WITHIN DIMENSIONS		THIS DRAWING CONTAINS INFORMATION THAT IS PROPRIETARY TO MOLEX INCORPORATED AND SHOULD NOT BE USED WITHOUT WRITTEN PERMISSION					

10 9 8 7 6 5 4 3 2 1

F

E

D

C

B

A

F

E

D

C

B

A

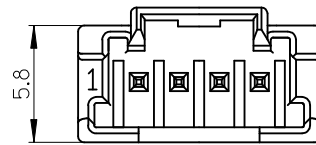
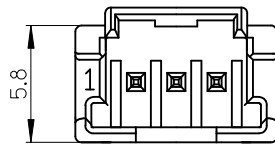
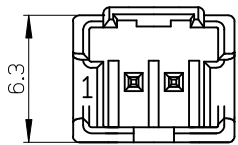
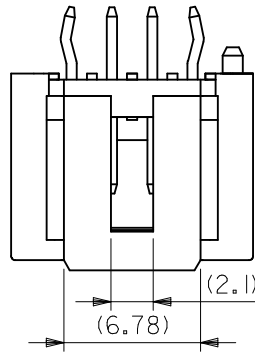
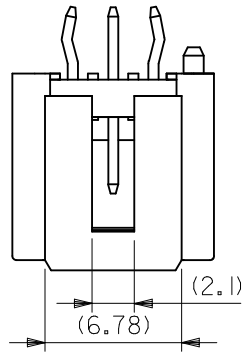
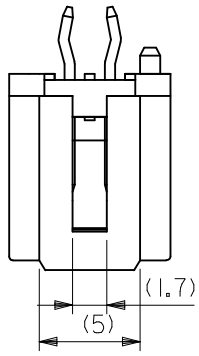

2 CIRCUIT

3 CIRCUIT

4 CIRCUIT 以上

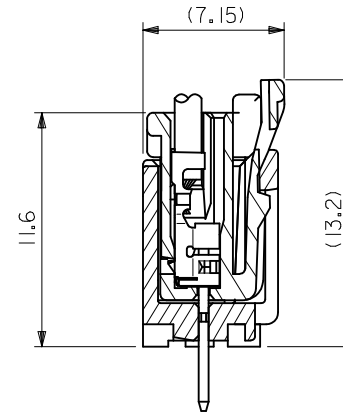

嵌合断面図

MODEL NO. : 55932-\*\*\*\*

REVISED EC NO: J2014-0496 DRWN: YAJI MA01 2013/09/18 CHKD: KASAKAWA 2013/09/19 APPR: NUKITA 2013/09/19	GENERAL TOLERANCES (UNLESS SPECIFIED)		DIMENSION STYLE MM ONLY	SCALE ---	DESIGN UNITS METRIC	THIRD ANGLE PROJECTION
	10 UNDER	±0.2	DRAWN BY T. NIITSU	DATE '02/02/08	TITLE 2.0 W/B SINGLE CONN. PLUG HOUSING ASS'Y ST -LEAD FREE-	
	10 OVER 30 UNDER	±0.25	CHECKED BY K. ASAKAWA	DATE '03/06/12	<b>molex</b> DOCUMENT NO. SD-55932-002 SHEET NO. 2 OF 2	
	30 OVER	±0.3	APPROVED BY T. YAMAGUCHI	DATE '03/06/12		
	ANGULAR ±3 °		MATERIAL NO. SEE CHART			
DRAFT WHERE APPLICABLE MUST REMAIN WITHIN DIMENSIONS		SIZE A3	THIS DRAWING CONTAINS INFORMATION THAT IS PROPRIETARY TO MOLEX INCORPORATED AND SHOULD NOT BE USED WITHOUT WRITTEN PERMISSION			

9 8 7 6 5 4 3 2