

571

CYCLING TIMER

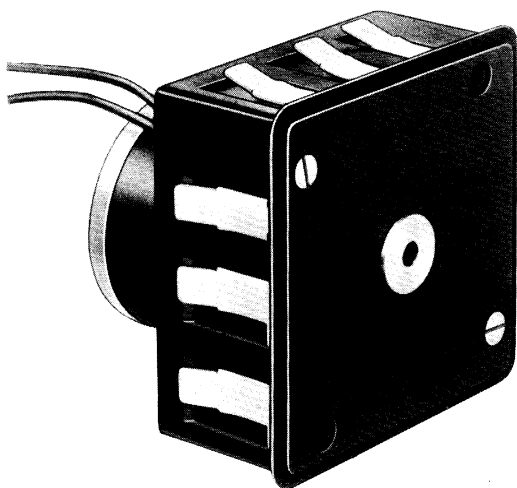

■ 1 minute to 8 day cycles ■ Operating accuracy within 1-1/2% ■ Simple, reliable, inexpensive ■ One through four cam-operated poles ■ Continuous or single cycle

DESCRIPTION

The Cramer 571 Cycling Timer provides repetitive electrical switching or cycling, particularly for built in applications. It runs continuously while the motor is energized, stops upon power interruption and resumes cycling with power restoration. The timer is available with one through four poles. A separate cam, cut to user specifications, operates each pole with an operating point accuracy within 1-1/2%. The unit can also be wired for single cycle operation and stop. This high contact rated and compact unit will perform in a variety of applications from vending machines or production equipment to advertising and point-of-sale displays.

SPECIFICATIONS

Speeds	See table—speeds shown are for 30 amp contacts. Faster speeds available with lower contact rating.
Input	2.75 W at rated voltage.
Ratings	Available in all standard voltages, 60 and 50 cycles. DC ratings also available.
Mounting	Can be face mounted using two holes in bakelite housing (with standard top plate bearing) or center hole mounted (with threaded mounting bearing) see dimensions.
Motor	Cramer High Torque Synchronous Motor
Switches	SPST or SPDT open-blade. No side—quick break, slow make. NC side—quick make, slow break.
Load Circuits	One through four poles, each pole controlled by a separate, specially cut cam.
Contacts	Silver-cadmium alloy, rated at 30 amperes, 115 vac resistive load (1/3 hp at 115 vac motor load).
Case	Molded black bakelite.
Accuracy	Within 1-1/2% of cycle at each operating point.

STANDARD SPEEDS—60 and 50 cycles

Speed	Time for one cycle	Speed	Time for one cycle
1 RPM	1 Min.	1 RPH	1 Hour.
1/2	2	1/2	2
1/4	4	1/4	4
1/8	8	1/8	8
1/12	12	1 RPD	1 Day
1/16	16	3/4	1 1/2
1/20	20	1/2	2
1/24	24	1/4	4
1/40	40	1/8	8

In addition, a wide selection of special speeds can be supplied on order.

Normally supplied without output shaft. Standard and to-spec shafts can be supplied. One-way friction for timer setting is also provided on order.

DIMENSIONS

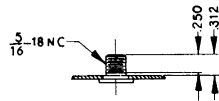
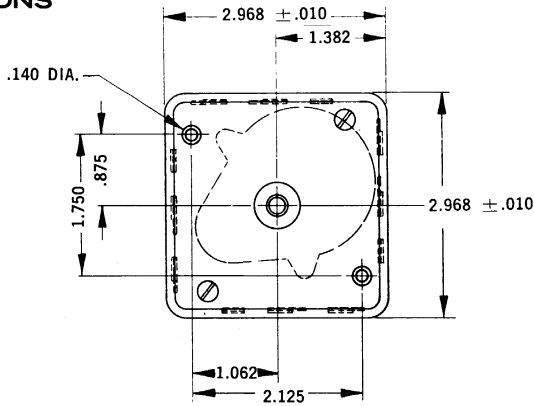

THREADED BEARING FOR CENTER HOLE MOUNT

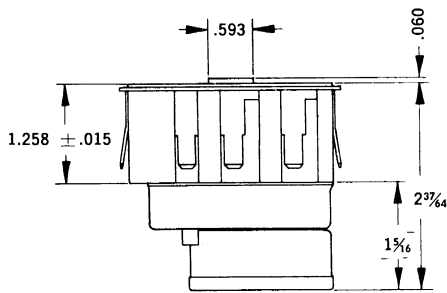

SPECIAL SHORT PULSE ARRANGEMENT

On special order, two pole Type 571 Timers can be equipped to provide minimum pulses down to 2° out of the 360° cam travel. The two switches are wired in series in order to provide the short pulse. The following are examples of some cycle-time and short-pulse combinations.

Time for one cycle	Min. pulse duration
60 sec.	1/3 sec.
5 min.	1-2/3 sec.
1 hour	20 sec.
24 hours	8 min.
8 days	64 min.

ORDERING INFORMATION

Specify: Timer Type (571)
 Voltage and Frequency
 Speed (Time for one cycle)
 Number of poles (SPST or SPDT), connected in amps.
 Timing cycle for each pole
 Mounting Style (face or center hole)
 Other special features (e.g., extension shaft, etc.)

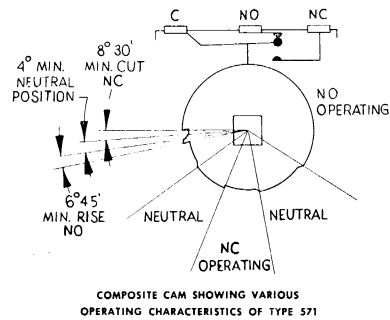

Cams are precision cut and set to specific requirements. Fixed to a square shaft, the cams are not subject to slippage even after long usage. They are not adjustable. Use Cramer Types 511, 521 or 540 for adjustability.

On special order, cams can be cut to provide a timed intermediate position (identified as "Neutral in sketch above) in which both contacts are open for double throw switches.

WIRING

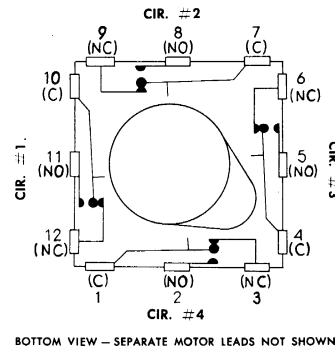

TYPICAL TIME DIAGRAM

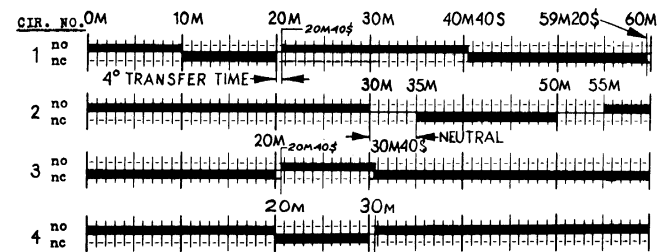

HEAVY BAR INDICATES CONTACTS CLOSED.

This diagram illustrates the graphic method for specifying time programs to be controlled by Type 571. All cams are cut according to specific requirements. Cir. #1 represents a standard 2-cut cam. Cir. #2 is a 3-level cam with timed "neutral" positions. Circuits #3 & #4 show the same timing but from opposite sides of the double throw switches.

DISTRICT SALES OFFICES

ATLANTA, Georgia
 3224 Peachtree Rd., N.E.
 237-0955

CHICAGO 39, Illinois
 4930 West Fullerton Ave.
 Merrimac 7-7502

OLD SAYBROOK, Connecticut
 Evergreen 8-3574
 TWX: 203-388-4397

PLAINVIEW, Long Island, N.Y.
 Expressway Industrial Park
 MU 3-8225, GE 3-1020

PASADENA, California
 1200 East Walnut St.
 Murray 1-1212, Sycamore 3-1985
 TWX: 213-449-2353

SOUTH BEND, Indiana
 5217 Floral Park
 AT 7-0225

WALTHAM, Massachusetts
 235 Bear Hill Rd.
 893-8181

WASHINGTON 16, D.C.
 4435 Wisconsin Ave., N.W.
 363-5587