

PCB LAYOUT - COMPONENT VIEW

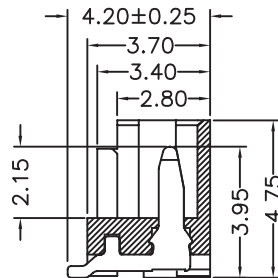
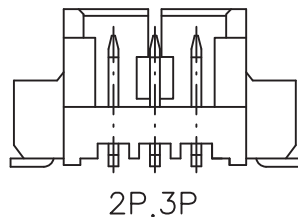
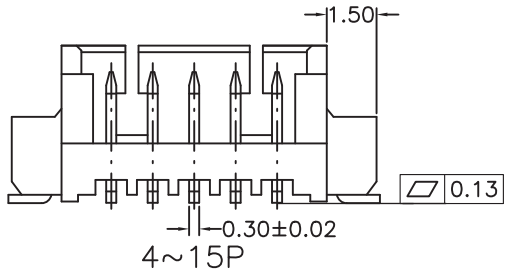

TECHNICAL CHARACTERISTICS

MATERIAL
 INSULATOR: NYLON 46
 FLAMABILITY RATING: UL94-V0
 COLOR: BEIGE
 CONTACT MATERIAL: COPPER ALLOY
 CONTACT TYPE: STAMPED
 CONTACT PLATING: TIN
 QUALITY CLASS: 25 MATING CYCLES
 PITCH: 1.25MM

ENVIRONMENTAL
 OPERATING TEMPERATURE: -40 UP TO 85°C
 COMPLIANCE: LEAD FREE AND ROHS

ELECTRICAL
 CURRENT RATING: 1A
 WORKING VOLTAGE: 125V AC
 INSULATOR RESISTANCE: >100 MOHM
 DIELECTRIC WITHSTANDING VOLTAGE: 250V AC/MN
 CONTACT RESISTANCE: 20 mOHM MAX

STANDARD
 CERTIFIED: E323964

SOLDERING
 SOLDER TEMP.: JEDEC LEAD FREE REFLOW SOLDERING

PACKAGING
 TAPE AND REEL

DIMENSION
 A = 1.25 x (NB PIN - 1)
 B = 1.25 x (NB PIN + 1) + 3.5
 C = 1.25 x (NB PIN + 1) + 0.5

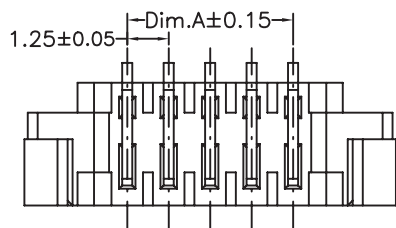

RoHS Compliant

G	07-AUG-13	CHARACTERISTIC	QL
F	21-MAR-13	COPLANARITY	AR
E	29-OCT-12	PIN	GG
D	22-JUN-12	P&P ZONE	GG
C	17-NOV-09	STANDARD	JP
B	25-MAY-09	PACKAGING	JC
A	23-JUN-08	PDF	CH
REV	DATE	FILE	BY

PROJECTION:	
APPROVAL: RJ	

GENERAL TOLERANCE
.X = +/- 0.2
.XX = +/- 0.15
UNIT: MM
SCALE:
SHEET: 1/2
DRAW: CEL KING

DESCRIPTION: 1.25 MM SMT MALE VERTICAL SHROUDED HEADER	
WERI PART NO: 6531xx124022	

SIZE
A4

1

2

3

4

5

PULL OUT DIRECTION

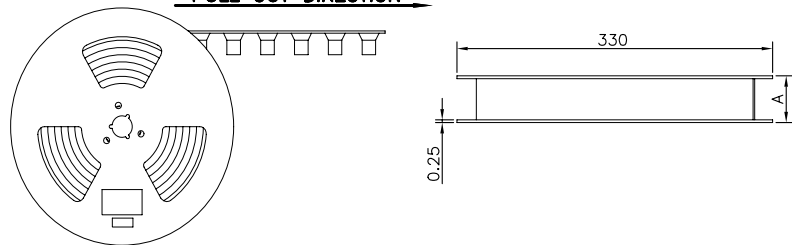

Note:

- 1.All dimensions meet EIA-481-3 requirements.
- 2.Material : Black Conductive Polystyrene Alloy
100% recyclable.
- 3.Thickness : 0.40±0.05mm
- 4.Component load per 13" reel :1000 pcs.
- 5,For Reel width (dimension W)16,24mm
Single row hole, (dimension W)32,44
Double rows hole
- 6.CARTON SIZE:350*350*296(MM)

A

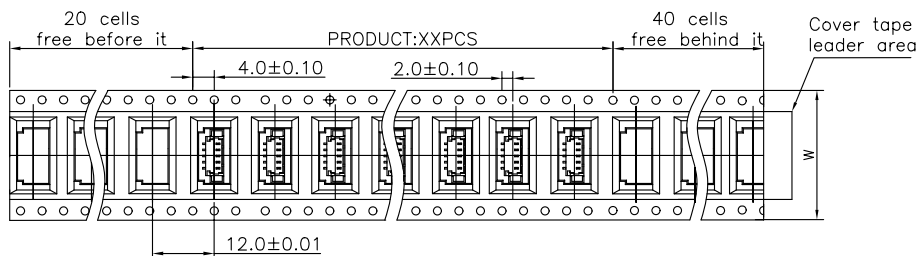

Pin No	W	A	PCS/R	R/CTN	Q'TY
02	24	29	1000	7	7000
03	24	19	1000	7	7000
04	24	29	1000	7	7000
05	24	29	1000	7	7000
06	24	29	1000	7	7000
07	24	29	1000	7	7000
08	24	29	1000	7	7000
09	24	29	1000	7	7000
10	32	37	1000	6	6000
11	32	37	1000	6	6000
12	32	37	1000	6	6000
13	32	37	1000	6	6000
14	32	37	1000	6	6000
15	44	49	1000	5	5000

B

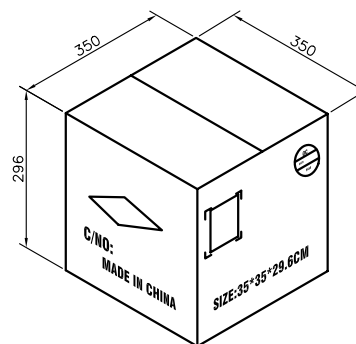
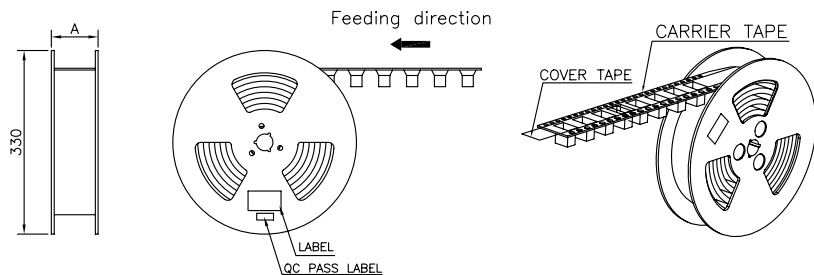

C

RoHS Compliant

G			
F			
E			
D			
C			
B			
A			
REV	DATE	FILE	BY

PROJECTION:

APPROVAL: RJ

GENERAL TOLERANCE
.X = +/- 0.2
.XX = +/- 0.15

UNIT: MM
SCALE:
SHEET: 2/2
DRAW: PEARL

DESCRIPTION: 1.25 SMT MALE VERTICAL SHROUDED HEADER

WERI PART NO: 6531 xx 124022_TPK

SIZE
A4

D