

**A Dimensions: [mm]**

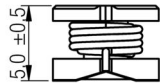

Scale - 2:1

**B Recommended land pattern: [mm]**

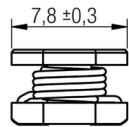
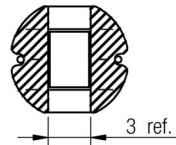
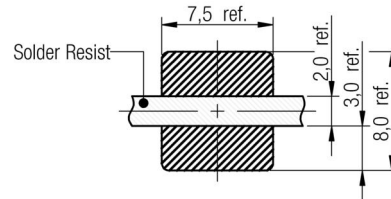

Scale - 2:1

**C Schematic:**



|     |            |     |         |
|-----|------------|-----|---------|
|     |            |     |         |
|     |            |     |         |
|     |            |     |         |
|     |            |     |         |
| 1.1 | 2013-04-18 | SSt | ALa     |
| 1.0 | 2004-10-11 | ALa | -       |
| REV | DATE       | BY  | CHECKED |

Projection

Würth Elektronik eiSos GmbH & Co. KG  
EMC & Inductive Solutions  
Max-Eyth-Str. 1  
74638 Waldenburg  
Germany  
Tel. +49 (0) 79 42 945 - 0  
www.we-online.com  
eiSos@we-online.com

|                                  |      |
|----------------------------------|------|
| DESCRIPTION                      |      |
| <b>WE-PD2 SMD Power Inductor</b> |      |
| Order.- No.                      | SIZE |
| <b>744775139</b>                 | A4   |
| Size: 7850                       |      |



**D Electrical Properties:**

| Properties                     | Test conditions |                  | Value | Unit | Tol. |
|--------------------------------|-----------------|------------------|-------|------|------|
| <b>Inductance</b>              | 10 kHz/ 100 mV  | L                | 39    | μH   | ±10% |
| <b>Rated current</b>           | ΔT = 40 K       | I <sub>R</sub>   | 1.25  | A    | max. |
| <b>Saturation current</b>      | ΔL/L  < 10%     | I <sub>sat</sub> | 1.33  | A    | typ. |
| <b>DC Resistance</b>           | @ 20°C          | R <sub>DC</sub>  | 0.116 | Ω    | typ. |
| <b>DC Resistance</b>           | @ 20°C          | R <sub>DC</sub>  | 0.16  | Ω    | max. |
| <b>Self resonant frequency</b> |                 | f <sub>res</sub> | 12    | MHz  | typ. |

**E General information:**

It is recommended that the temperature of the part does not exceed 125°C under worst case operating conditions.

- Ambient temperature: -40°C to +85°C (referring to I<sub>R</sub>)
- Operating temperature: -40°C to +125°C
- Storage temperature (on tape & reel): -20°C to +40°C; 75% RH max.
- Test conditions of Electrical Properties: 20°C, 33% RH if not specified differently



**F Typical Inductance vs. Current Characteristics:**

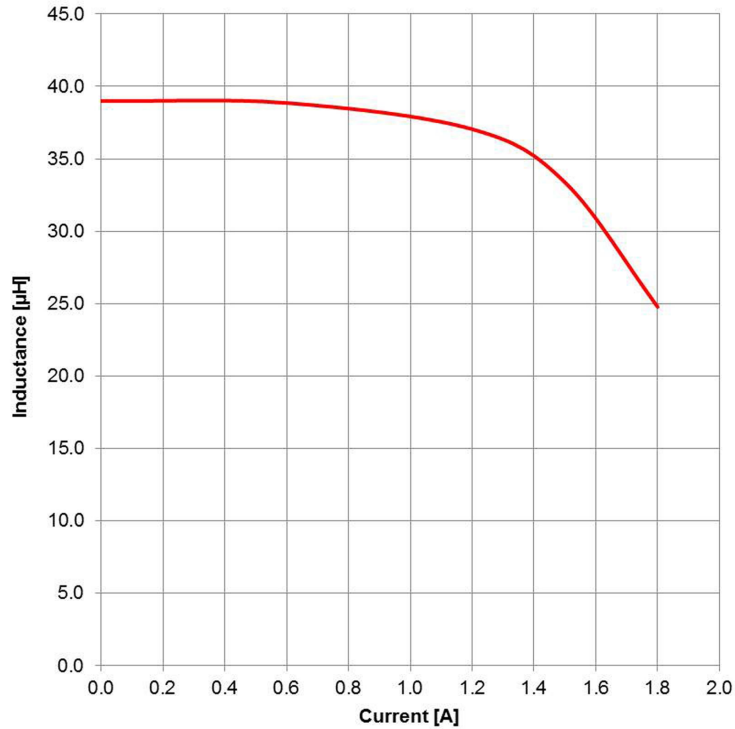

|     |            |     |         |   |   |                  |
|-----|------------|-----|---------|---|---|------------------|
|     |            |     |         | Projection<br>  | DESCRIPTION   |                  |
|     |            |     |         |   | <b>WE-PD2 SMD Power Inductor</b>                              |                  |
|     |            |     |         | Würth Elektronik eiSos GmbH & Co. KG<br>EMC & Inductive Solutions<br>Max-Eyth-Str. 1<br>74638 Waldenburg<br>Germany<br>Tel. +49 (0) 79 42 945 - 0<br>www.we-online.com<br>eiSos@we-online.com | Order.- No.   |                  |
| 1.1 | 2013-04-18 | SSt | ALa     |   | <b>COMPLIANT</b><br><b>RoHS&amp;REACH</b><br>WÜRTH ELEKTRONIK | SIZE             |
| 1.0 | 2004-10-11 | ALa | -       |   |   | <b>744775139</b> |
| REV | DATE       | BY  | CHECKED |   | Size: 7850  |                  |

This electronic component has been designed and developed for usage in general electronic equipment only. This product is not authorized for use in equipment where a higher safety standard and reliability standard is especially required or where a failure of the product is reasonably expected to cause severe personal injury or death, unless the parties have executed an agreement specifically governing such use. Moreover Würth Elektronik eiSos GmbH & Co KG products are neither designed nor intended for use in areas such as military, aerospace, aviation, nuclear control, submarine, transportation (automotive control, train control, ship control), transportation signal, disaster prevention, medical, public information network etc.. Würth Elektronik eiSos GmbH & Co KG must be informed about the intent of such usage before the design-in stage. In addition, sufficient reliability evaluation checks for safety must be performed on every electronic component which is used in electrical circuits that require high safety and reliability functions or performance.

### G Packaging Specification - Tape and Reel [mm]:



| size | A0        | B0    | W     | P1           | T     | T1    | T2   | D0   | E1           | E2    | F     | P0     | P2    | VPE / packaging unit |
|------|-----------|-------|-------|--------------|-------|-------|------|------|--------------|-------|-------|--------|-------|----------------------|
|      | tolerance | typ.  | typ.  | +0,3<br>-0,1 | ± 0,1 | ± 0,1 | max. | typ. | +0,3<br>-0,1 | ± 0,1 | min.  | ± 0,05 | ± 0,1 | ± 0,05               |
| 4532 | 4,50      | 5,50  | 16,00 | 8,00         | 0,35  | 0,10  | 4,00 | 1,50 | 1,75         | 14,25 | 7,50  | 4,00   | 2,00  | 1500                 |
| 5820 | 5,50      | 6,50  | 12,00 | 8,00         | 0,45  | 0,10  | 3,00 | 1,50 | 1,75         | 10,25 | 5,50  | 4,00   | 2,00  | 2000                 |
| 5848 | 5,50      | 6,50  | 16,00 | 8,00         | 0,35  | 0,10  | 5,50 | 1,50 | 1,75         | 14,25 | 7,50  | 4,00   | 2,00  | 1500                 |
| 7850 | 7,50      | 8,50  | 16,00 | 12,00        | 0,35  | 0,10  | 6,00 | 1,50 | 1,75         | 14,25 | 7,50  | 4,00   | 2,00  | 500                  |
| 1054 | 9,50      | 10,50 | 24,00 | 16,00        | 0,50  | 0,10  | 7,00 | 1,50 | 1,75         | 22,25 | 11,50 | 4,00   | 2,00  | 500                  |

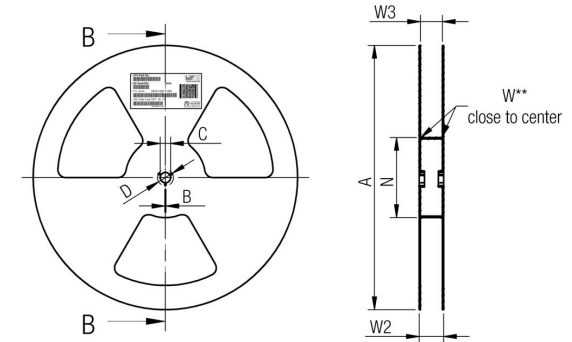

| tolerance        | A      | B    | C     | D     | N      | W1    | W2    | W3    | W3    |
|------------------|--------|------|-------|-------|--------|-------|-------|-------|-------|
|                  | ± 2,0  | min. | ± 0,8 | min.  | min.   | + 1,5 | max.  | min.  | max.  |
| Tape width 12 mm | 330,00 | 1,50 | 13,00 | 20,20 | 100,00 | 12,40 | 18,40 | 11,90 | 15,40 |
| Tape width 16 mm | 330,00 | 1,50 | 13,00 | 20,20 | 100,00 | 16,40 | 22,40 | 15,90 | 19,40 |
| Tape width 24 mm | 330,00 | 1,50 | 13,00 | 20,20 | 100,00 | 24,40 | 30,40 | 23,90 | 27,40 |

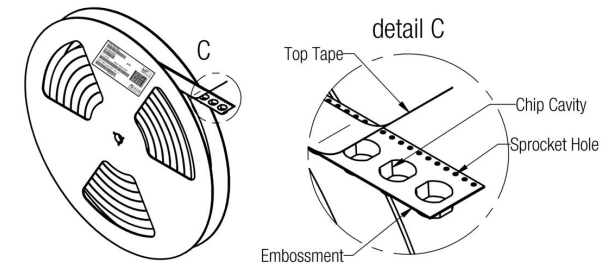

Packaging is referred to the international standard IEC 60286 -3:2007



| Tape width | Pull-of force |               |
|------------|---------------|---------------|
|            | 12 mm         | 0,1 N - 1,0 N |
|            | 16 mm         | 0,1 N - 1,3 N |
| 24 mm      | 0,1 N - 1,3 N |               |

| REV | DATE       | BY  | CHECKED |
|-----|------------|-----|---------|
| 1.1 | 2013-04-18 | SSt | ALa     |
| 1.0 | 2004-10-11 | ALa | -       |

Projection

Würth Elektronik eiSos GmbH & Co. KG  
EMC & Inductive Solutions  
Max-Eyth-Str. 1  
74638 Waldenburg  
Germany  
Tel. +49 (0) 79 42 945 - 0  
www.we-online.com  
eiSos@we-online.com

DESCRIPTION

## WE-PD2 SMD Power Inductor

Order.- No. **744775139**

Size: 7850

COMPLIANT RoHS&REACH WÜRTH ELEKTRONIK

SIZE  
A4

This electronic component has been designed and developed for usage in general electronic equipment only. This product is not authorized for use in equipment where a higher safety standard and reliability standard is especially required or where a failure of the product is reasonably expected to cause severe personal injury or death, unless the parties have executed an agreement specifically governing such use. Moreover Würth Elektronik eiSos GmbH & Co KG products are neither designed nor intended for use in areas such as military, aerospace, aviation, nuclear control, submarine, transportation (automotive control, train control, ship control), transportation signal, disaster prevention, medical, public information network etc.. Würth Elektronik eiSos GmbH & Co KG must be informed about the intent of such usage before the design-in stage. In addition, sufficient reliability evaluation checks for safety must be performed on every electronic component which is used in electrical circuits that require high safety and reliability functions or performance.

# H Soldering Specifications:



## H1: Classification Reflow Profile for SMT components:



## H2: Classification Reflow Profiles

| Profile Feature   | Pb-Free Assembly                 |
|---|----------------------------------|
| Preheat<br>- Temperature Min ( $T_{smin}$ )<br>- Temperature Max ( $T_{smax}$ )<br>- Time ( $t_s$ ) from ( $T_{smin}$ to $T_{smax}$ ) | 150°C<br>200°C<br>60-120 seconds |
| Ramp-up rate ( $T_L$ to $T_p$ )   | 3°C/ second max.                 |
| Liquidous temperature ( $T_L$ )<br>Time ( $t_L$ ) maintained above $T_L$  | 217°C<br>60-150 seconds          |
| Peak package body temperature ( $T_p$ )   | See Table H3                     |
| Time within 5°C of actual peak temperature ( $t_p$ )  | 20-30 seconds                    |
| Ramp-down rate ( $T_p$ to $T_L$ )   | 6°C/ second max.                 |
| Time 25°C to peak temperature   | 8 minutes max.                   |

refer to IPC/JEDEC J-STD-020D

## H3: Package Classification Reflow Temperature

|                         | Package Thickness | Volume mm <sup>3</sup> <350 | Volume mm <sup>3</sup> 350 - 2000 | Volume mm <sup>3</sup> >2000 |
|-------------------------|-------------------|-----------------------------|-----------------------------------|------------------------------|
| <b>PB-Free Assembly</b> | < 1.6 mm          | 260°C                       | 260°C                             | 260°C                        |
| <b>PB-Free Assembly</b> | 1.6 - 2.5 mm      | 260°C                       | 250°C                             | 245°C                        |
| <b>PB-Free Assembly</b> | ≥ 2.5 mm          | 250°C                       | 245°C                             | 245°C                        |

refer to IPC/JEDEC J-STD-020D

|     |            |     |         |   |                                  |      |
|-----|------------|-----|---------|---|----------------------------------|------|
|     |            |     |         | Projection<br>  | DESCRIPTION                      |      |
|     |            |     |         |   | <b>WE-PD2 SMD Power Inductor</b> |      |
| 1.1 | 2013-04-18 | SSt | ALa     | Würth Elektronik eiSos GmbH & Co. KG<br>EMC & Inductive Solutions<br>Max-Eyth-Str. 1<br>74638 Waldenburg<br>Germany<br>Tel. +49 (0) 79 42 945 - 0<br>www.we-online.com<br>eiSos@we-online.com | Order.- No.                      |      |
| 1.0 | 2004-10-11 | ALa | -       |   | <b>744775139</b>                 | SIZE |
| REV | DATE       | BY  | CHECKED |   | Size: 7850                       | A4   |



This electronic component has been designed and developed for usage in general electronic equipment only. This product is not authorized for use in equipment where a higher safety standard and reliability standard is especially required or where a failure of the product is reasonably expected to cause severe personal injury or death, unless the parties have executed an agreement specifically governing such use. Moreover Würth Elektronik eiSos GmbH & Co KG products are neither designed nor intended for use in areas such as military, aerospace, aviation, nuclear control, submarine, transportation (automotive control, train control, ship control), transportation signal, disaster prevention, medical, public information network etc.. Würth Elektronik eiSos GmbH & Co KG must be informed about the intent of such usage before the design-in stage. In addition, sufficient reliability evaluation checks for safety must be performed on every electronic component which is used in electrical circuits that require high safety and reliability functions or performance.

## I Cautions and Warnings:

The following conditions apply to all goods within the product series of WE-PD2 of Würth Elektronik eiSos GmbH & Co. KG:

### General:

All recommendations according to the general technical specifications of the data-sheet have to be complied with.

The disposal and operation of the product within ambient conditions which probably alloy or harm the wire isolation has to be avoided.

If the product is potted in customer applications, the potting material might shrink during and after hardening. Accordingly to this the product is exposed to the pressure of the potting material with the effect that the core, wire and termination is possibly damaged by this pressure and so the electrical as well as the mechanical characteristics are endanger to be affected. After the potting material is cured, the core, wire and termination of the product have to be checked if any reduced electrical or mechanical functions or destructions have occurred.

The responsibility for the applicability of customer specific products and use in a particular customer design is always within the authority of the customer. All technical specifications for standard products do also apply for customer specific products.

Cleaning agents that are used to clean application might damage or change the characteristics of the component, body, pins or termination.

Direct mechanical impact to the product shall be prevented as the core material could flake or in the worst case it could break.

### Product specific:

Follow all instructions mentioned in the datasheet, especially:

- The solder profile has to be complied with according to the technical reflow soldering specification, otherwise no warranty will be sustained.
- All products shall be used before the end of the period of 12 months based on the product date-code, if not a 100% solderability can't be warranted.
- Violation of the technical product specifications such as exceeding the nominal rated current will result in the loss of warranty.



|     |            |     |         |                |  |                                  |
|-----|------------|-----|---------|----------------|--|----------------------------------|
|     |            |     |         | Projection<br> |  | DESCRIPTION                      |
|     |            |     |         |                |  | <b>WE-PD2 SMD Power Inductor</b> |
|     |            |     |         |                |  | Order.- No. <b>744775139</b>     |
|     |            |     |         |                |  |                                  |
|     |            |     |         |                |  | SIZE<br>A4                       |
|     |            |     |         |                |  | Size: 7850                       |
| 1.1 | 2013-04-18 | SSt | ALa     |                |  |                                  |
| 1.0 | 2004-10-11 | ALa | -       |                |  |                                  |
| REV | DATE       | BY  | CHECKED |                |  |                                  |

Würth Elektronik eiSos GmbH & Co. KG  
 EMC & Inductive Solutions  
 Max-Eyth-Str. 1  
 74638 Waldenburg  
 Germany  
 Tel. +49 (0) 79 42 945 - 0  
 www.we-online.com  
 eiSos@we-online.com

## J Important Notes:

The following conditions apply to all goods within the product range of Würth Elektronik eiSos GmbH & Co. KG:



### 1. General Customer Responsibility

Some goods within the product range of Würth Elektronik eiSos GmbH & Co. KG contain statements regarding general suitability for certain application areas. These statements about suitability are based on our knowledge and experience of typical requirements concerning the areas, serve as general guidance and cannot be estimated as binding statements about the suitability for a customer application. The responsibility for the applicability and use in a particular customer design is always solely within the authority of the customer. Due to this fact it is up to the customer to evaluate, where appropriate to investigate and decide whether the device with the specific product characteristics described in the product specification is valid and suitable for the respective customer application or not.

### 2. Customer Responsibility related to Specific, in particular Safety-Relevant Applications

It has to be clearly pointed out that the possibility of a malfunction of electronic components or failure before the end of the usual lifetime cannot be completely eliminated in the current state of the art, even if the products are operated within the range of the specifications.

In certain customer applications requiring a very high level of safety and especially in customer applications in which the malfunction or failure of an electronic component could endanger human life or health it must be ensured by most advanced technological aid of suitable design of the customer application that no injury or damage is caused to third parties in the event of malfunction or failure of an electronic component.

Therefore, customer is cautioned to verify that data sheets are current before placing orders. The current data sheets can be downloaded at [www.we-online.com](http://www.we-online.com).

### 3. Best Care and Attention

Any product-specific notes, cautions and warnings must be strictly observed. Any disregard will result in the loss of warranty.

### 4. Customer Support for Product Specifications

Some products within the product range may contain substances which are subject to restrictions in certain jurisdictions in order to serve specific technical requirements. Necessary information is available on request. In this case the field sales engineer or the internal sales person in charge should be contacted who will be happy to support in this matter.

### 5. Product R&D

Due to constant product improvement product specifications may change from time to time. As a standard reporting procedure of the Product Change Notification (PCN) according to the JEDEC-Standard inform about minor and major changes. In case of further queries regarding the PCN, the field sales engineer or the internal sales person in charge should be contacted. The basic responsibility of the customer as per Section 1 and 2 remains unaffected.

### 6. Product Life Cycle

Due to technical progress and economical evaluation we also reserve the right to discontinue production and delivery of products. As a standard reporting procedure of the Product Termination Notification (PTN) according to the JEDEC-Standard we will inform at an early stage about inevitable product discontinuance. According to this we cannot guarantee that all products within our product range will always be available. Therefore it needs to be verified with the field sales engineer or the internal sales person in charge about the current product availability expectancy before or when the product for application design-in disposal is considered. The approach named above does not apply in the case of individual agreements deviating from the foregoing for customer-specific products.



### 7. Property Rights

All the rights for contractual products produced by Würth Elektronik eiSos GmbH & Co. KG on the basis of ideas, development contracts as well as models or templates that are subject to copyright, patent or commercial protection supplied to the customer will remain with Würth Elektronik eiSos GmbH & Co. KG.

Würth Elektronik eiSos GmbH & Co. KG does not warrant or represent that any license, either expressed or implied, is granted under any patent right, copyright, mask work right, or other intellectual property right relating to any combination, application, or process in which Würth Elektronik eiSos GmbH & Co. KG components or services are used.

### 8. General Terms and Conditions

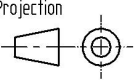
Unless otherwise agreed in individual contracts, all orders are subject to the current version of the "General Terms and Conditions of Würth Elektronik eiSos Group", last version available at [www.we-online.com](http://www.we-online.com).

|     |            |     |         |   |   |      |
|-----|------------|-----|---------|---|---|------|
|     |            |     |         | Projection<br>   | DESCRIPTION   |      |
|     |            |     |         |   | <b>WE-PD2 SMD Power Inductor</b>  |      |
|     |            |     |         | Würth Elektronik eiSos GmbH & Co. KG<br>EMC & Inductive Solutions<br>Max-Eyth-Str. 1<br>74638 Waldenburg<br>Germany<br>Tel. +49 (0) 79 42 945 - 0<br><a href="http://www.we-online.com">www.we-online.com</a><br><a href="mailto:eiSos@we-online.com">eiSos@we-online.com</a> | Order.- No.<br><b>744775139</b><br>Size: 7850   |      |
| 1.1 | 2013-04-18 | SSt | ALa     |   |  | SIZE |
| 1.0 | 2004-10-11 | ALa | -       |   |   | A4   |
| REV | DATE       | BY  | CHECKED |   |   |      |