

## FEATURES

### Low wideband noise

 1 nV/ $\sqrt{\text{Hz}}$ 

 2.6 pA/ $\sqrt{\text{Hz}}$ 

### Low 1/f noise: 2 nV/ $\sqrt{\text{Hz}}$ at 10 Hz

### Low distortion (SFDR): -96 dBc at 100 kHz, $V_{\text{OUT}} = 2 \text{ V p-p}$

### Low power: 3 mA per amplifier

### Low input offset voltage: 350 $\mu\text{V}$ maximum

### High speed

 236 MHz, -3 dB bandwidth ( $G = +10$ )

 943 V/ $\mu\text{s}$  slew rate

22 ns settling time to 0.1%

### Rail-to-rail output

### Wide supply range: 3 V to 10 V

### Disable feature

## APPLICATIONS

### Low noise preamplifier

### Ultrasound amplifiers

### PLL loop filters

### High performance ADC drivers

### DAC buffers

## GENERAL DESCRIPTION

The ADA4895-2 is a dual, high speed voltage feedback amplifier that is gain  $\geq 10$  stable with low input noise, rail-to-rail output, and quiescent current of 3 mA per amplifier. With a 1/f noise of 2 nV/ $\sqrt{\text{Hz}}$  at 10 Hz and a spurious-free dynamic range of -72 dBc at 2 MHz, the ADA4895-2 is an ideal solution in a variety of applications, including ultrasound, low noise preamplifiers, and drivers of high performance ADCs. The Analog Devices, Inc., proprietary next generation SiGe bipolar process and innovative architecture enable this high performance amplifier.

The ADA4895-2 has a large signal bandwidth of 146 MHz at a gain of +10 with a slew rate of 943 V/ $\mu\text{s}$ , and settles to 0.1% in 22 ns. The wide supply voltage range (3 V to 10 V) of the ADA4895-2 makes this amplifier an ideal candidate for systems that require high dynamic range, high gain, precision, and high speed.

The ADA4895-2 is available in a 10-lead MSOP package and operates over the extended industrial temperature range of -40°C to +125°C.

## FUNCTIONAL BLOCK DIAGRAM

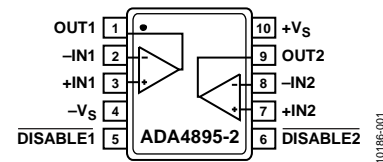

Figure 1. 10-Lead MSOP

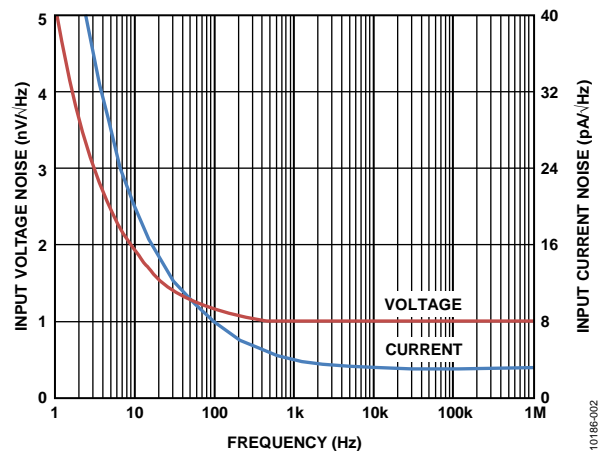

Figure 2. Input Voltage and Current Noise vs. Frequency

 Table 1. Other Low Noise Amplifiers<sup>1</sup>

| Part No.                | $V_N$ @ 1 kHz<br>(nV/ $\sqrt{\text{Hz}}$ ) | $V_N$ @ 100 kHz<br>(nV/ $\sqrt{\text{Hz}}$ ) | BW (MHz) | Supply<br>Voltage (V) |
|-------------------------|--|--|----------|-----------------------|
| AD8021                  | 4.2  | 2.1  | 490      | 5 to 24               |
| AD8045                  | 6  | 3  | 1000     | 3.3 to 12             |
| AD8099                  | 7  | 0.95   | 510      | 5 to 12               |
| ADA4841-1/<br>ADA4841-2 | 2.2  | 2.1  | 80       | 2.7 to 12             |
| ADA4896-2               | 1  | 1  | 230      | 3 to 10               |
| ADA4897-1/<br>ADA4897-2 | 1  | 1  | 230      | 3 to 10               |
| ADA4898-1/<br>ADA4898-2 | 0.9  | 0.9  | 65       | 10 to 32              |
| ADA4899-1               | 1.4  | 1  | 600      | 5 to 12               |

<sup>1</sup> See [www.analog.com](http://www.analog.com) for the latest selection of low noise amplifiers.

## COMPANION PRODUCTS

**ADCs: AD7944 (14-bit), AD7985 (16-bit), AD7986 (18-bit)**
**Additional companion products on the [ADA4895-2 product page](#)**

**TABLE OF CONTENTS**

|  |    |   |    |
|--|----|---|----|
| Features .....                                   | 1  | Typical Performance Characteristics .....   | 11 |
| Applications.....                                | 1  | Theory of Operation .....                   | 17 |
| General Description .....                        | 1  | Amplifier Description.....                  | 17 |
| Functional Block Diagram .....                   | 1  | Input Protection .....                      | 17 |
| Companion Products .....                         | 1  | Disable Operation .....                     | 17 |
| Revision History .....                           | 2  | DC Errors .....                             | 18 |
| Specifications.....                              | 3  | Bias Current Cancellation .....             | 18 |
| ±5 V (or +10 V) Supply .....                     | 3  | Noise Considerations.....                   | 19 |
| ±2.5 V (or +5 V) Supply .....                    | 5  | Applications Information .....              | 20 |
| ±1.5 V (or +3 V) Supply .....                    | 7  | Using the ADA4895-2 at a Gain < +10.....    | 20 |
| Absolute Maximum Ratings.....                    | 9  | High Gain Bandwidth Application .....       | 21 |
| Thermal Resistance .....                         | 9  | Wideband Photomultiplier Preamplifier ..... | 22 |
| Maximum Power Dissipation .....                  | 9  | Layout Considerations.....                  | 23 |
| ESD Caution.....                                 | 9  | Outline Dimensions .....                    | 24 |
| Pin Configuration and Function Descriptions..... | 10 | Ordering Guide .....                        | 24 |

**REVISION HISTORY**

9/12—Revision 0: Initial Version

## SPECIFICATIONS

### ±5 V (OR +10 V) SUPPLY

$T_A = 25^\circ\text{C}$ ,  $G = +10$ ,  $R_F = 249\ \Omega$ ,  $R_L = 1\ \text{k}\Omega$  to midsupply, unless otherwise noted.

Table 2.

| Parameter                         | Test Conditions/Comments  | Min   | Typ          | Max  | Unit                         |
|-----------------------------------|---|-------|--------------|------|------------------------------|
| <b>DYNAMIC PERFORMANCE</b>        |   |       |              |      |                              |
| –3 dB Bandwidth                   | $V_{OUT} = 0.2\ \text{V p-p}$   |       | 236          |      | MHz                          |
|                                   | $V_{OUT} = 2\ \text{V p-p}$   |       | 146          |      | MHz                          |
|                                   | $V_{OUT} = 0.2\ \text{V p-p}$ , $G = +20$ , $R_F = 1\ \text{k}\Omega$ |       | 115          |      | MHz                          |
| Bandwidth for 0.1 dB Flatness     | $V_{OUT} = 2\ \text{V p-p}$ , $R_L = 100\ \Omega$                     |       | 8.9          |      | MHz                          |
| Slew Rate                         | $V_{OUT} = 6\ \text{V step}$  |       | 943          |      | V/ $\mu\text{s}$             |
| Settling Time to 0.1%             | $V_{OUT} = 2\ \text{V step}$  |       | 22           |      | ns                           |
| <b>NOISE/HARMONIC PERFORMANCE</b> |   |       |              |      |                              |
| Harmonic Distortion (SFDR)        | $f_C = 100\ \text{kHz}$ , $V_{OUT} = 2\ \text{V p-p}$                 |       | –96          |      | dBc                          |
|                                   | $f_C = 1\ \text{MHz}$ , $V_{OUT} = 2\ \text{V p-p}$                   |       | –78          |      | dBc                          |
|                                   | $f_C = 2\ \text{MHz}$ , $V_{OUT} = 2\ \text{V p-p}$                   |       | –72          |      | dBc                          |
|                                   | $f_C = 5\ \text{MHz}$ , $V_{OUT} = 2\ \text{V p-p}$                   |       | –64          |      | dBc                          |
| Input Voltage Noise               | $f = 10\ \text{Hz}$ , $G = +25.9$                                     |       | 2            |      | nV/ $\sqrt{\text{Hz}}$       |
|                                   | $f = 100\ \text{kHz}$ , $G = +25.9$                                   |       | 1            |      | nV/ $\sqrt{\text{Hz}}$       |
| Input Current Noise               | $f = 10\ \text{Hz}$   |       | 14           |      | pA/ $\sqrt{\text{Hz}}$       |
|                                   | $f = 100\ \text{kHz}$   |       | 2.6          |      | pA/ $\sqrt{\text{Hz}}$       |
| 0.1 Hz to 10 Hz Noise             | $G = +101$ , $R_F = 1\ \text{k}\Omega$ , $R_G = 10\ \Omega$           |       | 99           |      | nV p-p                       |
| <b>DC PERFORMANCE</b>             |   |       |              |      |                              |
| Input Offset Voltage              |   | –350  | +53          | +350 | $\mu\text{V}$                |
| Input Offset Voltage Drift        |   |       | 0.15         |      | $\mu\text{V}/^\circ\text{C}$ |
| Input Bias Current                |   | –16   | –11          | –6   | $\mu\text{A}$                |
| Input Bias Current Drift          |   |       | 1.2          |      | nA/ $^\circ\text{C}$         |
| Input Bias Offset Current         |   | –0.6  | –0.02        | +0.6 | $\mu\text{A}$                |
| Open-Loop Gain                    | $V_{OUT} = -4\ \text{V to } +4\ \text{V}$                             | 100   | 110          |      | dB                           |
| <b>INPUT CHARACTERISTICS</b>      |   |       |              |      |                              |
| Input Resistance                  | Common mode/differential  |       | 10 M/10 k    |      | $\Omega$                     |
| Input Capacitance                 | Common mode/differential  |       | 3/11         |      | pF                           |
| Input Common-Mode Voltage Range   |   |       | –4.9 to +4.1 |      | V                            |
| Common-Mode Rejection             | $V_{CM} = -2\ \text{V to } +2\ \text{V}$                              | –92   | –109         |      | dB                           |
| <b>OUTPUT CHARACTERISTICS</b>     |   |       |              |      |                              |
| Output Overdrive Recovery Time    | $V_{IN} = -0.55\ \text{V to } +0.55\ \text{V}$                        |       | 80           |      | ns                           |
| Positive Output Voltage Swing     | $R_L = 1\ \text{k}\Omega$   | 4.85  | 4.96         |      | V                            |
|                                   | $R_L = 100\ \Omega$   | 4.5   | 4.77         |      | V                            |
| Negative Output Voltage Swing     | $R_L = 1\ \text{k}\Omega$   | –4.85 | –4.97        |      | V                            |
|                                   | $R_L = 100\ \Omega$   | –4.5  | –4.85        |      | V                            |
| Linear Output Current             | SFDR = –45 dBc  |       | 72           |      | mA rms                       |
| Short-Circuit Current             | Sinking/sourcing  |       | 116/108      |      | mA                           |
| Capacitive Load Drive             | 30% overshoot   |       | 6            |      | pF                           |
| <b>POWER SUPPLY</b>               |   |       |              |      |                              |
| Operating Range                   |   |       | 3 to 10      |      | V                            |
| Quiescent Current per Amplifier   |   | 2.8   | 3            | 3.2  | mA                           |
|                                   | $\overline{\text{DISABLEx}} = -5\ \text{V}$                           |       | 0.1          |      | mA                           |
| Positive Power Supply Rejection   | $+V_S = 4\ \text{V to } 6\ \text{V}$ , $-V_S = -5\ \text{V}$          | –96   | –136         |      | dB                           |
| Negative Power Supply Rejection   | $+V_S = 5\ \text{V}$ , $-V_S = -4\ \text{V to } -6\ \text{V}$         | –96   | –135         |      | dB                           |

| <b>Parameter</b>                   | <b>Test Conditions/Comments</b>            | <b>Min</b> | <b>Typ</b>    | <b>Max</b> | <b>Unit</b>   |
|------------------------------------|--|------------|---------------|------------|---------------|
| <b>DISABLEx PIN</b>                |  |            |               |            |               |
| DISABLEx Voltage                   | Part enabled                               |            | $>+V_S - 0.5$ |            | V             |
|                                    | Part disabled                              |            | $<+V_S - 2$   |            | V             |
| <b>Input Current per Amplifier</b> |  |            |               |            |               |
| Part Enabled                       | $\overline{\text{DISABLEx}} = +5\text{ V}$ |            | -1.1          |            | $\mu\text{A}$ |
| Part Disabled                      | $\overline{\text{DISABLEx}} = -5\text{ V}$ |            | -40           |            | $\mu\text{A}$ |
| <b>Switching Speed</b>             |  |            |               |            |               |
| Part Enabled                       |  |            | 0.25          |            | $\mu\text{s}$ |
| Part Disabled                      |  |            | 6             |            | $\mu\text{s}$ |

**±2.5 V (OR +5 V) SUPPLY**

$T_A = 25^\circ\text{C}$ ,  $G = +10$ ,  $R_F = 249\ \Omega$ ,  $R_L = 1\ \text{k}\Omega$  to midsupply, unless otherwise noted.

Table 3.

| Parameter                         | Test Conditions/Comments  | Min   | Typ          | Max  | Unit                         |
|-----------------------------------|---|-------|--------------|------|------------------------------|
| <b>DYNAMIC PERFORMANCE</b>        |   |       |              |      |                              |
| –3 dB Bandwidth                   | $V_{OUT} = 0.2\ \text{V p-p}$   |       | 216          |      | MHz                          |
|                                   | $V_{OUT} = 2\ \text{V p-p}$   |       | 131          |      | MHz                          |
|                                   | $V_{OUT} = 0.2\ \text{V p-p}$ , $G = +20$ , $R_F = 1\ \text{k}\Omega$ |       | 113          |      | MHz                          |
| Bandwidth for 0.1 dB Flatness     | $V_{OUT} = 2\ \text{V p-p}$ , $R_L = 100\ \Omega$                     |       | 7.9          |      | MHz                          |
| Slew Rate                         | $V_{OUT} = 3\ \text{V step}$  |       | 706          |      | V/ $\mu\text{s}$             |
| Settling Time to 0.1%             | $V_{OUT} = 2\ \text{V step}$  |       | 21           |      | ns                           |
| <b>NOISE/HARMONIC PERFORMANCE</b> |   |       |              |      |                              |
| Harmonic Distortion (SFDR)        | $f_C = 100\ \text{kHz}$ , $V_{OUT} = 2\ \text{V p-p}$                 |       | –94          |      | dBc                          |
|                                   | $f_C = 1\ \text{MHz}$ , $V_{OUT} = 2\ \text{V p-p}$                   |       | –75          |      | dBc                          |
|                                   | $f_C = 2\ \text{MHz}$ , $V_{OUT} = 2\ \text{V p-p}$                   |       | –69          |      | dBc                          |
|                                   | $f_C = 5\ \text{MHz}$ , $V_{OUT} = 2\ \text{V p-p}$                   |       | –61          |      | dBc                          |
| Input Voltage Noise               | $f = 10\ \text{Hz}$ , $G = +25.9$                                     |       | 1.8          |      | nV/ $\sqrt{\text{Hz}}$       |
|                                   | $f = 100\ \text{kHz}$ , $G = +25.9$                                   |       | 1            |      | nV/ $\sqrt{\text{Hz}}$       |
| Input Current Noise               | $f = 10\ \text{Hz}$   |       | 14           |      | pA/ $\sqrt{\text{Hz}}$       |
|                                   | $f = 100\ \text{kHz}$   |       | 2.7          |      | pA/ $\sqrt{\text{Hz}}$       |
| 0.1 Hz to 10 Hz Noise             | $G = +101$ , $R_F = 1\ \text{k}\Omega$ , $R_G = 10\ \Omega$           |       | 99           |      | nV p-p                       |
| <b>DC PERFORMANCE</b>             |   |       |              |      |                              |
| Input Offset Voltage              |   | –350  | +53          | +350 | $\mu\text{V}$                |
| Input Offset Voltage Drift        |   |       | 0.15         |      | $\mu\text{V}/^\circ\text{C}$ |
| Input Bias Current                |   | –16   | –11          | –6   | $\mu\text{A}$                |
| Input Bias Current Drift          |   |       | 1.2          |      | nA/ $^\circ\text{C}$         |
| Input Bias Offset Current         |   | –0.6  | –0.02        | +0.6 | $\mu\text{A}$                |
| Open-Loop Gain                    | $V_{OUT} = -2\ \text{V to } +2\ \text{V}$                             | 97    | 108          |      | dB                           |
| <b>INPUT CHARACTERISTICS</b>      |   |       |              |      |                              |
| Input Resistance                  | Common mode/differential  |       | 10 M/10 k    |      | $\Omega$                     |
| Input Capacitance                 | Common mode/differential  |       | 3/11         |      | pF                           |
| Input Common-Mode Voltage Range   |   |       | –2.4 to +1.6 |      | V                            |
| Common-Mode Rejection             | $V_{CM} = -1.5\ \text{V to } +1.5\ \text{V}$                          | –91   | –110         |      | dB                           |
| <b>OUTPUT CHARACTERISTICS</b>     |   |       |              |      |                              |
| Output Overdrive Recovery Time    | $V_{IN} = -0.275\ \text{V to } +0.275\ \text{V}$                      |       | 90           |      | ns                           |
| Positive Output Voltage Swing     | $R_L = 1\ \text{k}\Omega$   | 2.35  | 2.48         |      | V                            |
|                                   | $R_L = 100\ \Omega$   | 2.3   | 2.38         |      | V                            |
| Negative Output Voltage Swing     | $R_L = 1\ \text{k}\Omega$   | –2.35 | –2.48        |      | V                            |
|                                   | $R_L = 100\ \Omega$   | –2.3  | –2.38        |      | V                            |
| Linear Output Current             | SFDR = –45 dBc  |       | 60           |      | mA rms                       |
| Short-Circuit Current             | Sinking/sourcing  |       | 113/95       |      | mA                           |
| Capacitive Load Drive             | 30% overshoot   |       | 6            |      | pF                           |
| <b>POWER SUPPLY</b>               |   |       |              |      |                              |
| Operating Range                   |   |       | 3 to 10      |      | V                            |
| Quiescent Current per Amplifier   |   | 2.6   | 2.8          | 3    | mA                           |
|                                   | $\overline{\text{DISABLEx}} = -2.5\ \text{V}$                         |       | 0.05         |      | mA                           |
| Positive Power Supply Rejection   | $+V_S = 2\ \text{V to } 3\ \text{V}$ , $-V_S = -2.5\ \text{V}$        | –96   | –137         |      | dB                           |
| Negative Power Supply Rejection   | $+V_S = 2.5\ \text{V}$ , $-V_S = -3\ \text{V to } -2\ \text{V}$       | –96   | –141         |      | dB                           |

| <b>Parameter</b>                   | <b>Test Conditions/Comments</b>               | <b>Min</b> | <b>Typ</b>    | <b>Max</b> | <b>Unit</b>   |
|------------------------------------|---|------------|---------------|------------|---------------|
| <b>DISABLEx PIN</b>                |   |            |               |            |               |
| DISABLEx Voltage                   | Part enabled                                  |            | $>+V_S - 0.5$ |            | V             |
|                                    | Part disabled                                 |            | $<+V_S - 2$   |            | V             |
| <b>Input Current per Amplifier</b> |   |            |               |            |               |
| Part Enabled                       | $\overline{\text{DISABLEx}} = +2.5 \text{ V}$ |            | -1.1          |            | $\mu\text{A}$ |
| Part Disabled                      | $\overline{\text{DISABLEx}} = -2.5 \text{ V}$ |            | -20           |            | $\mu\text{A}$ |
| <b>Switching Speed</b>             |   |            |               |            |               |
| Part Enabled                       |   |            | 0.25          |            | $\mu\text{s}$ |
| Part Disabled                      |   |            | 6             |            | $\mu\text{s}$ |

**±1.5 V (OR +3 V) SUPPLY**

$T_A = 25^\circ\text{C}$ ,  $G = +10$ ,  $R_F = 249\ \Omega$ ,  $R_L = 1\ \text{k}\Omega$  to midsupply, unless otherwise noted.

Table 4.

| Parameter                         | Test Conditions/Comments  | Min   | Typ          | Max  | Unit                         |
|-----------------------------------|---|-------|--------------|------|------------------------------|
| <b>DYNAMIC PERFORMANCE</b>        |   |       |              |      |                              |
| –3 dB Bandwidth                   | $V_{OUT} = 0.2\ \text{V p-p}$   |       | 205          |      | MHz                          |
|                                   | $V_{OUT} = 1\ \text{V p-p}$   |       | 131          |      | MHz                          |
|                                   | $V_{OUT} = 0.2\ \text{V p-p}$ , $G = +20$ , $R_F = 1\ \text{k}\Omega$ |       | 111          |      | MHz                          |
| Bandwidth for 0.1 dB Flatness     | $V_{OUT} = 2\ \text{V p-p}$ , $R_L = 100\ \Omega$                     |       | 7.5          |      | MHz                          |
| Slew Rate                         | $V_{OUT} = 1\ \text{V step}$  |       | 384          |      | V/ $\mu\text{s}$             |
| Settling Time to 0.1%             | $V_{OUT} = 2\ \text{V step}$  |       | 20           |      | ns                           |
| <b>NOISE/HARMONIC PERFORMANCE</b> |   |       |              |      |                              |
| Harmonic Distortion (SFDR)        | $f_C = 100\ \text{kHz}$ , $V_{OUT} = 2\ \text{V p-p}$                 |       | –92          |      | dBc                          |
|                                   | $f_C = 1\ \text{MHz}$ , $V_{OUT} = 2\ \text{V p-p}$                   |       | –73          |      | dBc                          |
|                                   | $f_C = 2\ \text{MHz}$ , $V_{OUT} = 2\ \text{V p-p}$                   |       | –67          |      | dBc                          |
|                                   | $f_C = 5\ \text{MHz}$ , $V_{OUT} = 2\ \text{V p-p}$                   |       | –59          |      | dBc                          |
| Input Voltage Noise               | $f = 10\ \text{Hz}$ , $G = +25.9$                                     |       | 1.9          |      | nV/ $\sqrt{\text{Hz}}$       |
|                                   | $f = 100\ \text{kHz}$ , $G = +25.9$                                   |       | 1            |      | nV/ $\sqrt{\text{Hz}}$       |
| Input Current Noise               | $f = 10\ \text{Hz}$   |       | 14           |      | pA/ $\sqrt{\text{Hz}}$       |
|                                   | $f = 100\ \text{kHz}$   |       | 2.7          |      | pA/ $\sqrt{\text{Hz}}$       |
| 0.1 Hz to 10 Hz Noise             | $G = +101$ , $R_F = 1\ \text{k}\Omega$ , $R_G = 10\ \Omega$           |       | 99           |      | nV p-p                       |
| <b>DC PERFORMANCE</b>             |   |       |              |      |                              |
| Input Offset Voltage              |   | –350  | +55          | +350 | $\mu\text{V}$                |
| Input Offset Voltage Drift        |   |       | 0.15         |      | $\mu\text{V}/^\circ\text{C}$ |
| Input Bias Current                |   | –16   | –11          | –6   | $\mu\text{A}$                |
| Input Bias Current Drift          |   |       | 1.2          |      | nA/ $^\circ\text{C}$         |
| Input Bias Offset Current         |   | –0.6  | –0.02        | +0.6 | $\mu\text{A}$                |
| Open-Loop Gain                    | $V_{OUT} = -1\ \text{V to } +1\ \text{V}$                             | 95    | 106          |      | dB                           |
| <b>INPUT CHARACTERISTICS</b>      |   |       |              |      |                              |
| Input Resistance                  | Common mode/differential  |       | 10 M/10 k    |      | $\Omega$                     |
| Input Capacitance                 | Common mode/differential  |       | 3/11         |      | pF                           |
| Input Common-Mode Voltage Range   |   |       | –1.4 to +0.6 |      | V                            |
| Common-Mode Rejection             | $V_{CM} = -0.4\ \text{V to } +0.4\ \text{V}$                          | –90   | –110         |      | dB                           |
| <b>OUTPUT CHARACTERISTICS</b>     |   |       |              |      |                              |
| Output Overdrive Recovery Time    | $V_{IN} = -0.165\ \text{V to } +0.165\ \text{V}$                      |       | 80           |      | ns                           |
| Positive Output Voltage Swing     | $R_L = 1\ \text{k}\Omega$   | 1.35  | 1.48         |      | V                            |
|                                   | $R_L = 100\ \Omega$   | 1.3   | 1.43         |      | V                            |
| Negative Output Voltage Swing     | $R_L = 1\ \text{k}\Omega$   | –1.35 | –1.49        |      | V                            |
|                                   | $R_L = 100\ \Omega$   | –1.3  | –1.45        |      | V                            |
| Linear Output Current             | SFDR = –45 dBc  |       | 43           |      | mA rms                       |
| Short-Circuit Current             | Sinking/sourcing  |       | 102/80       |      | mA                           |
| Capacitive Load Drive             | 30% overshoot   |       | 6            |      | pF                           |
| <b>POWER SUPPLY</b>               |   |       |              |      |                              |
| Operating Range                   |   |       | 3 to 10      |      | V                            |
| Quiescent Current per Amplifier   |   | 2.5   | 2.7          | 2.9  | mA                           |
|                                   | $\overline{\text{DISABLEx}} = -1.5\ \text{V}$                         |       | 0.03         |      | mA                           |
| Positive Power Supply Rejection   | $+V_S = 1.2\ \text{V to } 2.2\ \text{V}$ , $-V_S = -1.5\ \text{V}$    | –96   | –133         |      | dB                           |
| Negative Power Supply Rejection   | $+V_S = 1.5\ \text{V}$ , $-V_S = -2.2\ \text{V to } -1.2\ \text{V}$   | –96   | –146         |      | dB                           |

| <b>Parameter</b>                   | <b>Test Conditions/Comments</b>               | <b>Min</b> | <b>Typ</b>    | <b>Max</b> | <b>Unit</b>   |
|------------------------------------|---|------------|---------------|------------|---------------|
| <b>DISABLEx PIN</b>                |   |            |               |            |               |
| DISABLEx Voltage                   | Part enabled                                  |            | $>+V_S - 0.5$ |            | V             |
|                                    | Part disabled                                 |            | $<+V_S - 2$   |            | V             |
| <b>Input Current per Amplifier</b> |   |            |               |            |               |
| Part Enabled                       | $\overline{\text{DISABLEx}} = +1.5 \text{ V}$ |            | -1.2          |            | $\mu\text{A}$ |
| Part Disabled                      | $\overline{\text{DISABLEx}} = -1.5 \text{ V}$ |            | -10           |            | $\mu\text{A}$ |
| <b>Switching Speed</b>             |   |            |               |            |               |
| Part Enabled                       |   |            | 0.25          |            | $\mu\text{s}$ |
| Part Disabled                      |   |            | 6             |            | $\mu\text{s}$ |



## ABSOLUTE MAXIMUM RATINGS

Table 5.

| Parameter                           | Rating   |
|-------------------------------------|--|
| Supply Voltage                      | 11 V   |
| Power Dissipation                   | See Figure 3                                       |
| Common-Mode Input Voltage           | -V <sub>S</sub> - 0.7 V to +V <sub>S</sub> + 0.7 V |
| Differential Input Voltage          | ±0.7 V   |
| Storage Temperature Range           | -65°C to +125°C                                    |
| Operating Temperature Range         | -40°C to +125°C                                    |
| Lead Temperature (Soldering 10 sec) | 300°C  |
| Junction Temperature                | 150°C  |

Stresses above those listed under Absolute Maximum Ratings may cause permanent damage to the device. This is a stress rating only; functional operation of the device at these or any other conditions above those indicated in the operational section of this specification is not implied. Exposure to absolute maximum rating conditions for extended periods may affect device reliability.

### THERMAL RESISTANCE

θ<sub>JA</sub> is specified for the worst-case conditions, that is, θ<sub>JA</sub> is specified for a device soldered in a circuit board for surface-mount packages. Table 6 lists the θ<sub>JA</sub> for the ADA4895-2.

Table 6. Thermal Resistance

| Package Type      | θ <sub>JA</sub> | Unit |
|-------------------|-----------------|------|
| 10-Lead Dual MSOP | 210             | °C/W |

### MAXIMUM POWER DISSIPATION

The maximum safe power dissipation for the ADA4895-2 is limited by the associated rise in junction temperature (T<sub>J</sub>) on the die. At approximately 150°C, which is the glass transition temperature, the properties of the plastic change. Even temporarily exceeding this temperature limit can change the stresses that the package exerts on the die, permanently shifting the parametric performance of the ADA4895-2. Exceeding a junction temperature of 175°C for an extended period of time can result in changes in silicon devices, potentially causing degradation or loss of functionality.

The power dissipated in the package (P<sub>D</sub>) is the sum of the quiescent power dissipation and the power dissipated in the die due to the ADA4895-2 drive at the output.

$$P_D = \text{Quiescent Power} + (\text{Total Drive Power} - \text{Load Power})$$

The quiescent power dissipation is the voltage between the supply pins (±V<sub>S</sub>) multiplied by the quiescent current (I<sub>S</sub>).

$$P_D = (V_S \times I_S) + \left( \frac{V_S}{2} \times \frac{V_{OUT}}{R_L} \right) - \frac{V_{OUT}^2}{R_L}$$

RMS output voltages should be considered. If R<sub>L</sub> is referenced to -V<sub>S</sub>, as in single-supply operation, the total drive power is V<sub>S</sub> × I<sub>OUT</sub>. In single-supply operation with R<sub>L</sub> referenced to -V<sub>S</sub>, the worst case is V<sub>OUT</sub> = V<sub>S</sub>/2.

If the rms signal levels are indeterminate, consider the worst case, when V<sub>OUT</sub> = V<sub>S</sub>/4 with R<sub>L</sub> referenced to midsupply.

$$P_D = (V_S \times I_S) + \frac{(V_S/4)^2}{R_L}$$

Airflow increases heat dissipation, effectively reducing θ<sub>JA</sub>. Also, more metal directly in contact with the package leads reduces θ<sub>JA</sub>.

Figure 3 shows the maximum safe power dissipation in the package vs. the ambient temperature on a JEDEC standard, 4-layer board. θ<sub>JA</sub> values are approximations.

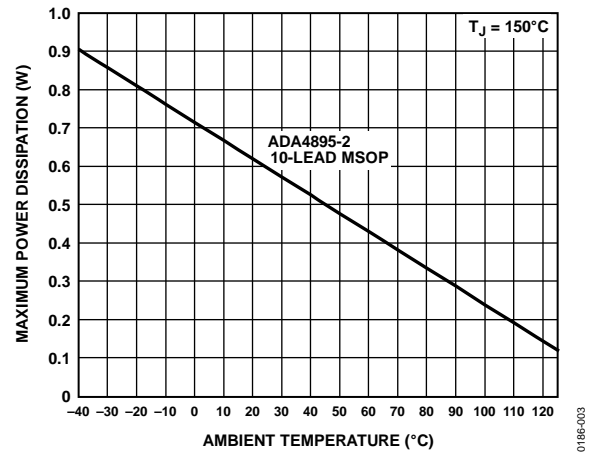

Figure 3. Maximum Power Dissipation vs. Temperature for a 4-Layer Board

### ESD CAUTION



**ESD (electrostatic discharge) sensitive device.** Charged devices and circuit boards can discharge without detection. Although this product features patented or proprietary protection circuitry, damage may occur on devices subjected to high energy ESD. Therefore, proper ESD precautions should be taken to avoid performance degradation or loss of functionality.

## PIN CONFIGURATION AND FUNCTION DESCRIPTIONS

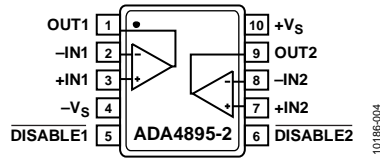

Figure 4. Pin Configuration

Table 7. Pin Function Descriptions

| Pin No. | Mnemonic                     | Description           |
|---------|------------------------------|-----------------------|
| 1       | OUT1                         | Output 1.             |
| 2       | -IN1                         | Inverting Input 1.    |
| 3       | +IN1                         | Noninverting Input 1. |
| 4       | -V <sub>S</sub>              | Negative Supply.      |
| 5       | $\overline{\text{DISABLE1}}$ | Disable 1.            |
| 6       | $\overline{\text{DISABLE2}}$ | Disable 2.            |
| 7       | +IN2                         | Noninverting Input 2. |
| 8       | -IN2                         | Inverting Input 2.    |
| 9       | OUT2                         | Output 2.             |
| 10      | +V <sub>S</sub>              | Positive Supply.      |

# TYPICAL PERFORMANCE CHARACTERISTICS

$T_A = 25^\circ\text{C}$ ,  $V_S = \pm 2.5\text{ V}$ ,  $G = +10$ ,  $R_F = 249\ \Omega$ ,  $R_L = 1\ \text{k}\Omega$  to midsupply, unless otherwise noted.

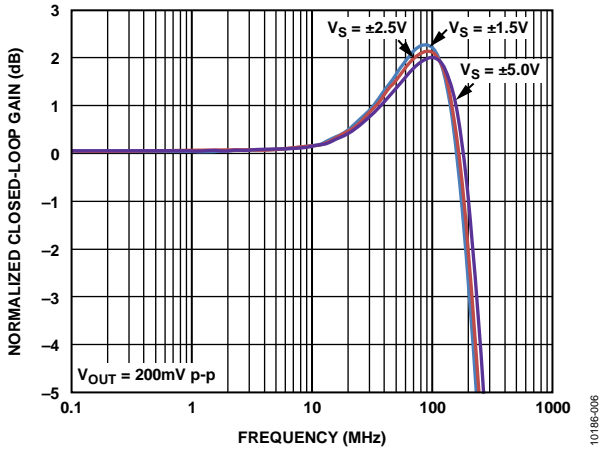

Figure 5. Small Signal Frequency Response vs. Supply Voltage

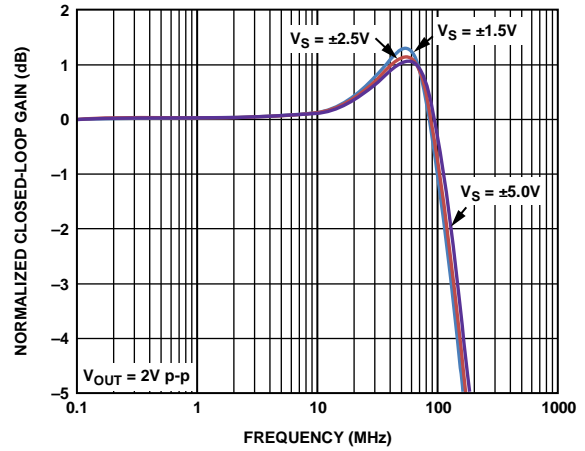

Figure 8. Large Signal Frequency Response vs. Supply Voltage

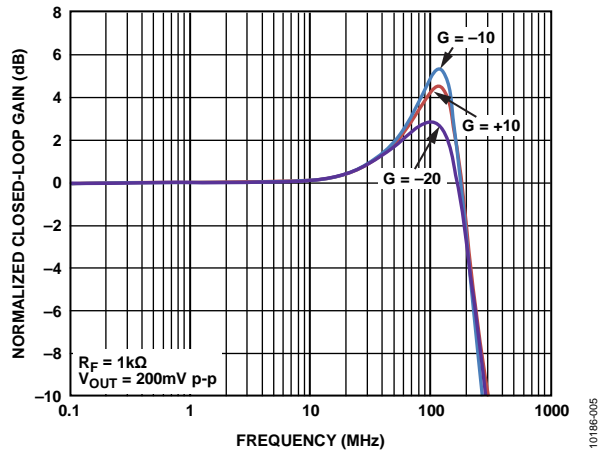

Figure 6. Small Signal Frequency Response vs. Gain

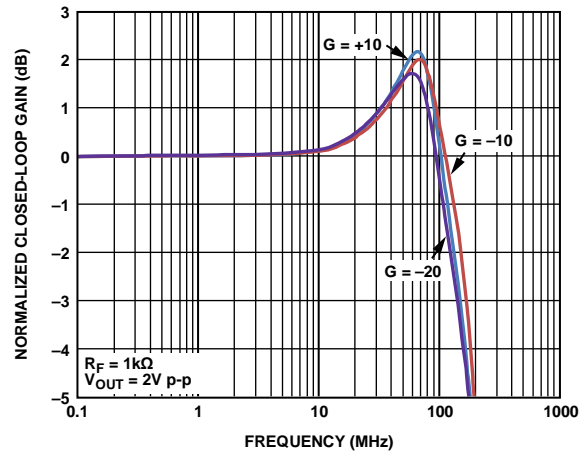

Figure 9. Large Signal Frequency Response vs. Gain

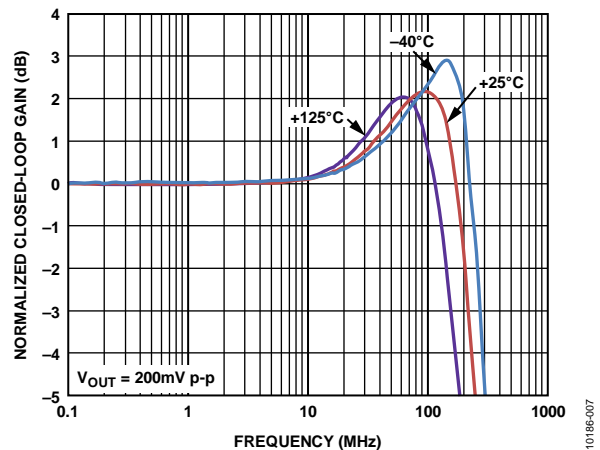

Figure 7. Small Signal Frequency Response vs. Temperature

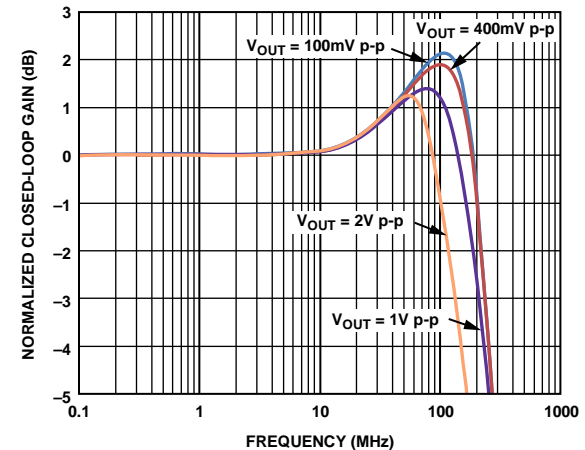

Figure 10. Frequency Response for Various Output Voltages

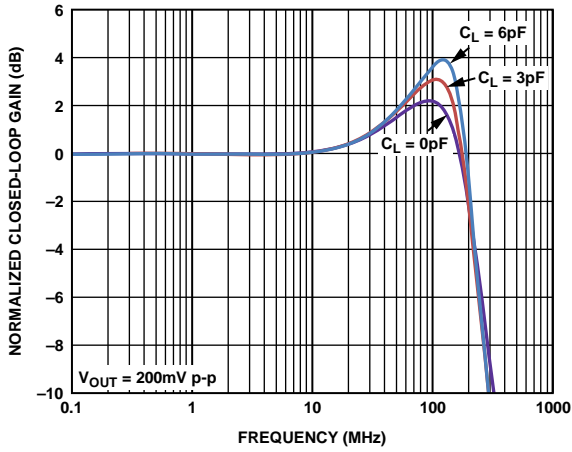

Figure 11. Small Signal Frequency Response vs. Capacitive Load

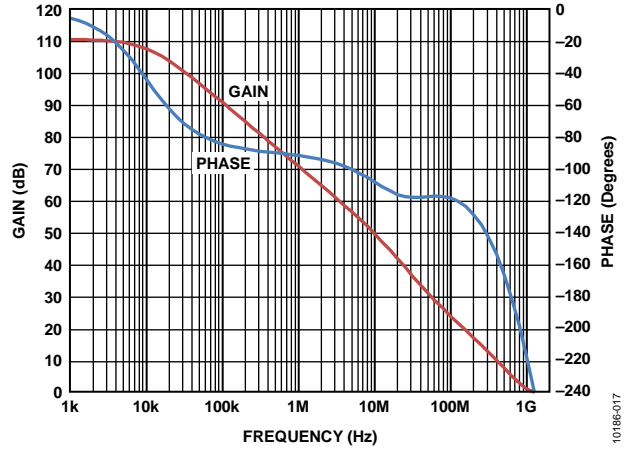

Figure 14. Open-Loop Gain and Phase vs. Frequency

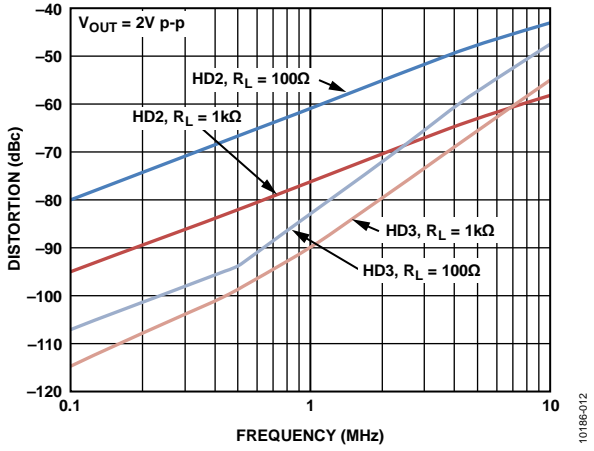

Figure 12. Harmonic Distortion vs. Frequency for Various Loads

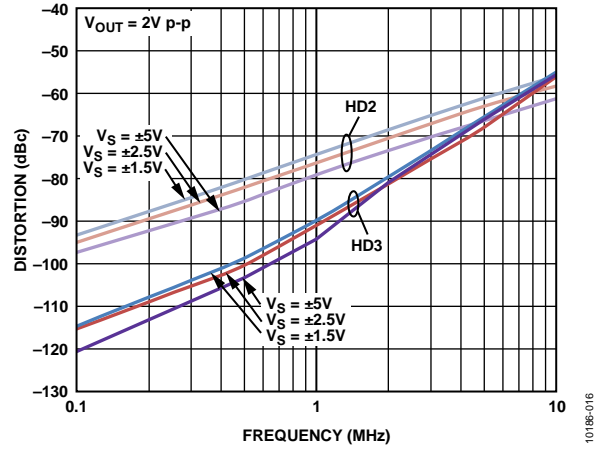

Figure 15. Harmonic Distortion vs. Frequency for Various Supplies

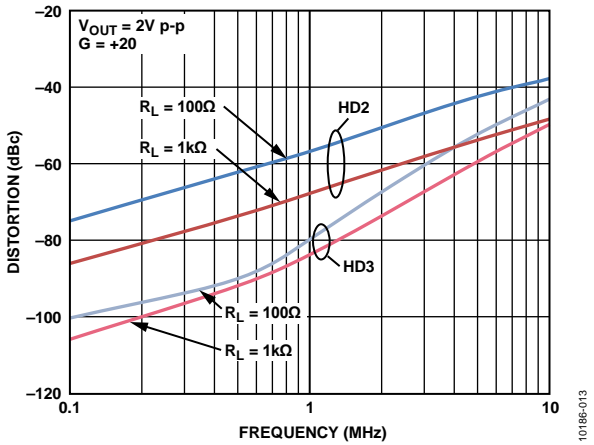

Figure 13. Harmonic Distortion vs. Frequency,  $G = +20$

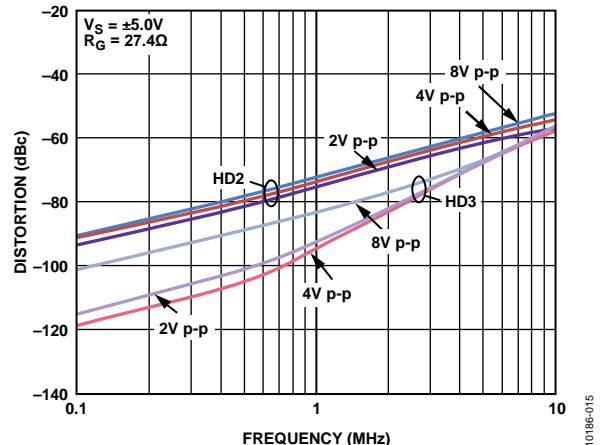

Figure 16. Harmonic Distortion vs. Frequency for Various Output Voltages

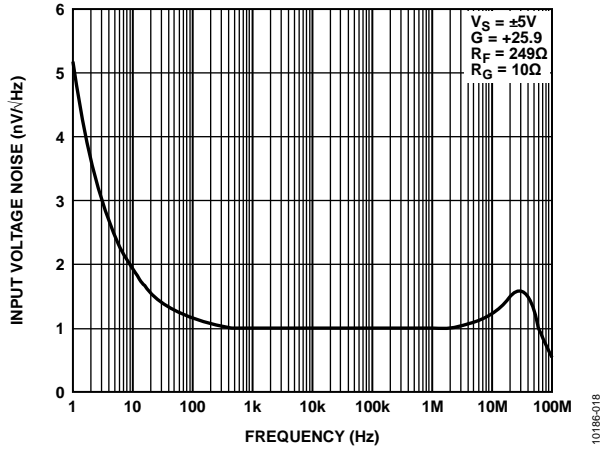

Figure 17. Input Voltage Noise vs. Frequency

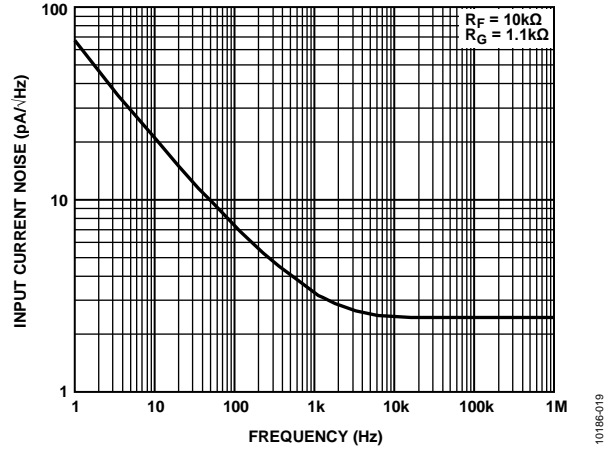

Figure 20. Input Current Noise vs. Frequency

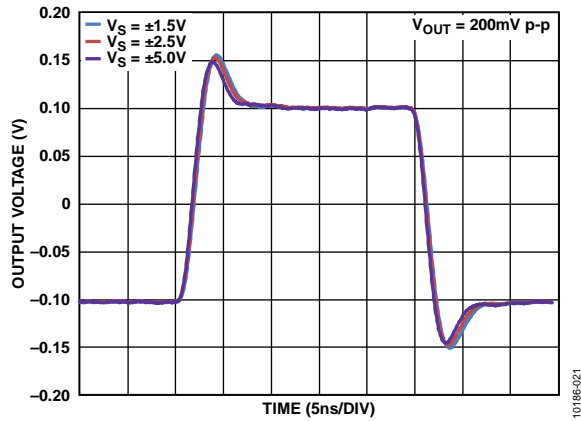

Figure 18. Small Signal Transient Response for Various Supplies

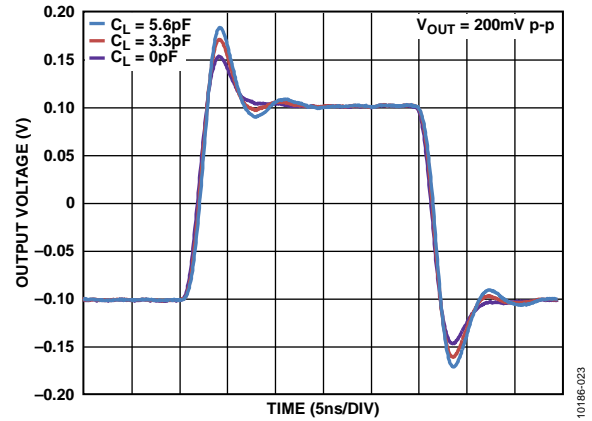

Figure 21. Small Signal Transient Response for Various Capacitive Loads

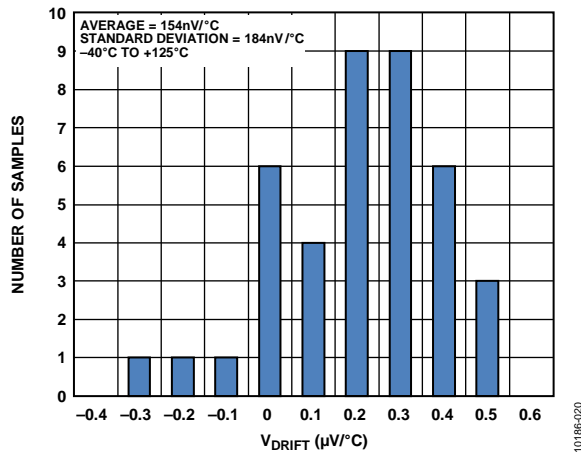

Figure 19. Input Offset Voltage Drift Distribution

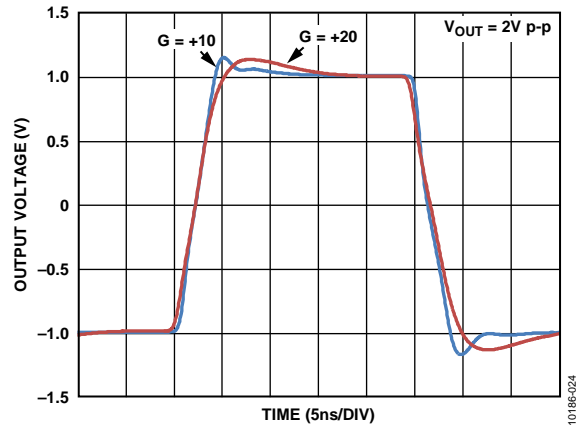

Figure 22. Large Signal Transient Response for Various Gains

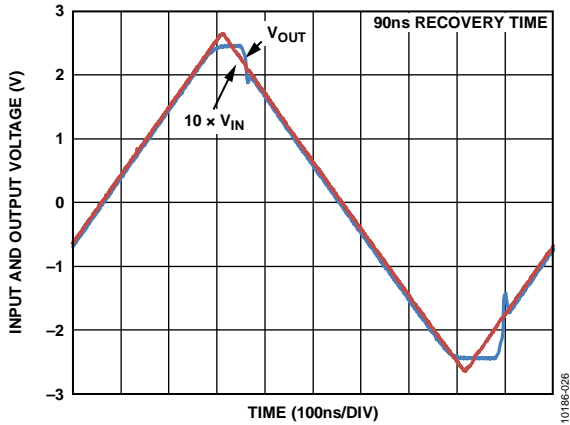

Figure 23. Output Overdrive Recovery Time

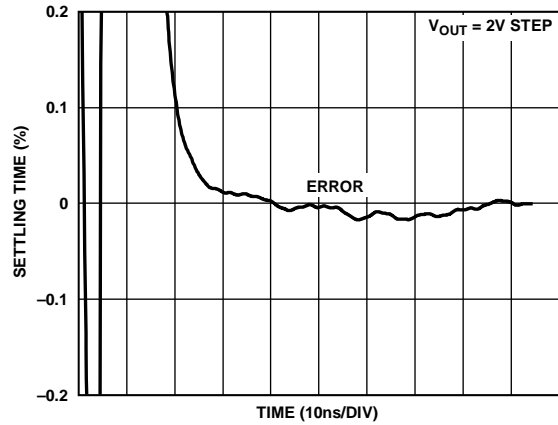

Figure 26. Settling Time to 0.1%

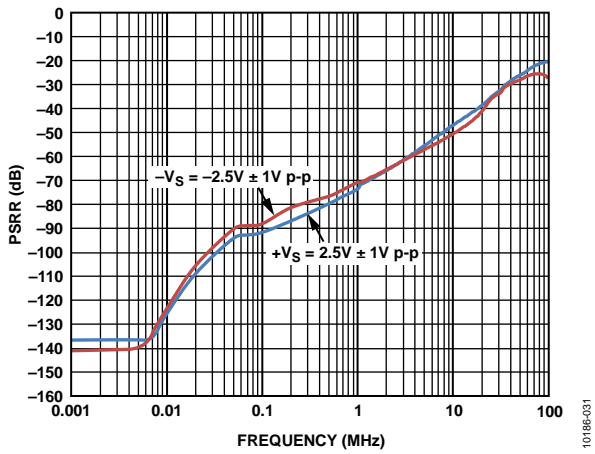

Figure 24. PSRR vs. Frequency

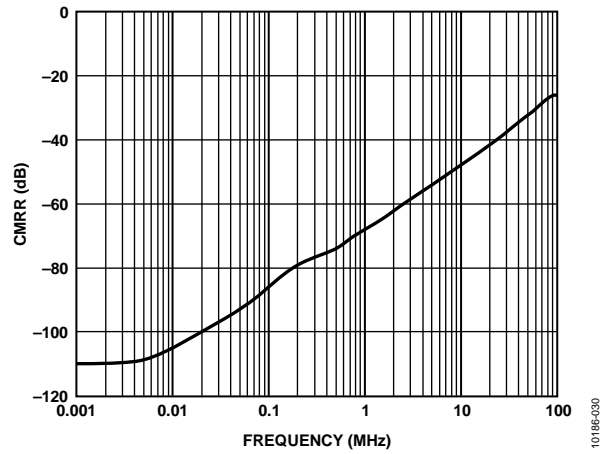

Figure 27. CMRR vs. Frequency

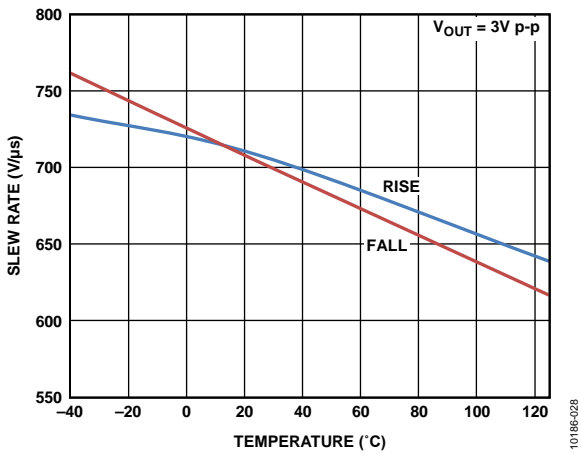

Figure 25. Slew Rate vs. Temperature

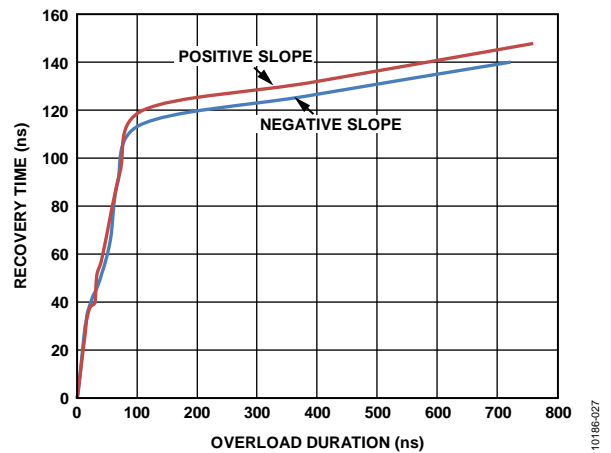

Figure 28. Output Overload Recovery Time vs. Overload Duration

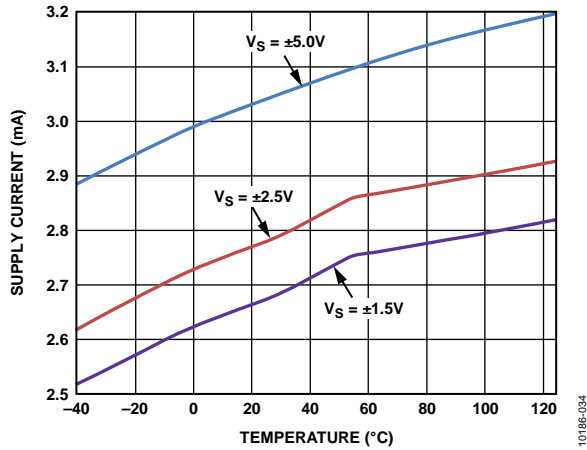

Figure 29. Supply Current vs. Temperature for Various Supplies

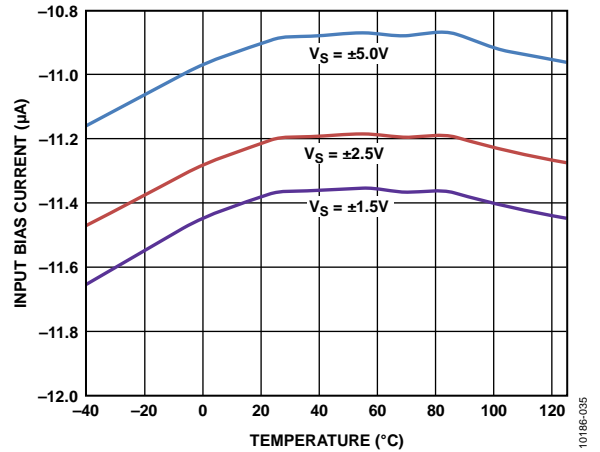

Figure 32. Input Bias Current vs. Temperature for Various Supplies

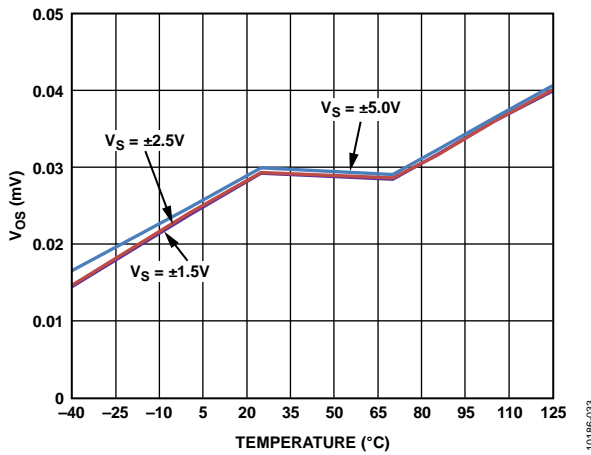

Figure 30. Input Offset Voltage vs. Temperature for Various Supplies

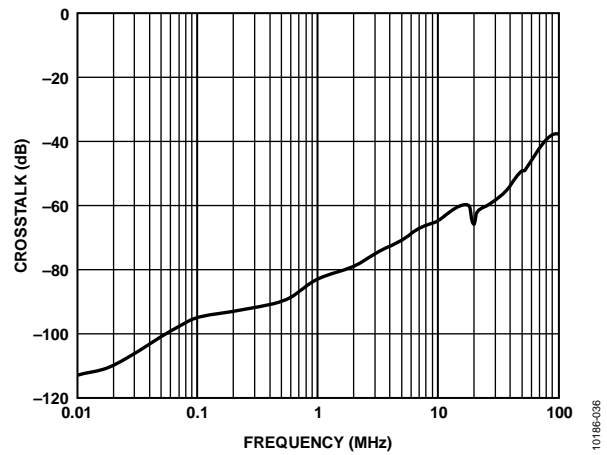

Figure 33. Crosstalk, OUT1 to OUT2

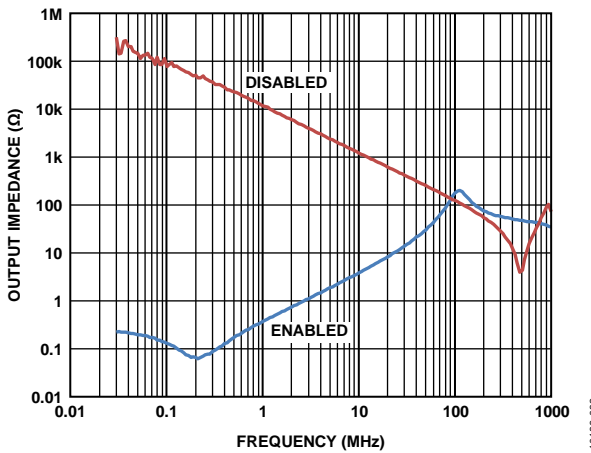

Figure 31. Output Impedance vs. Frequency

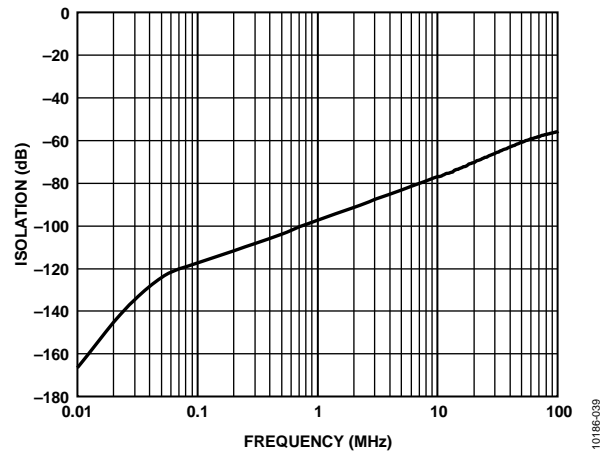

Figure 34. Forward Isolation vs. Frequency

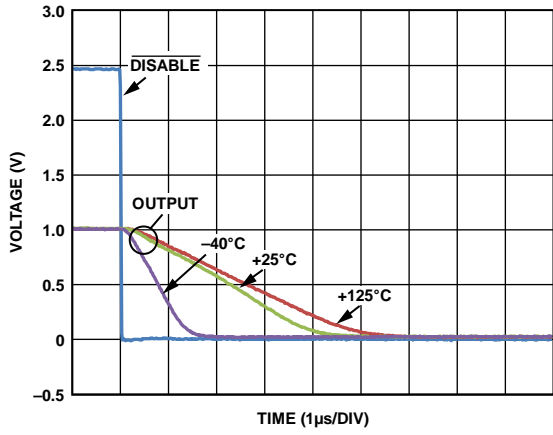

Figure 35. Output Turn-Off Time vs. Temperature

10186-038

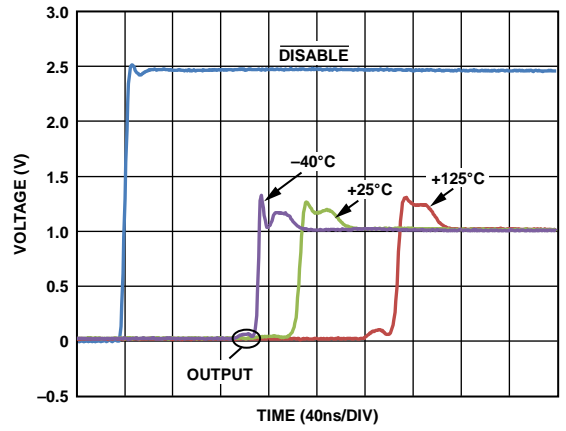

Figure 36. Output Turn-On Time vs. Temperature

10186-037



## THEORY OF OPERATION

### AMPLIFIER DESCRIPTION

The ADA4895-2 amplifier has an input noise of 1 nV/ $\sqrt{\text{Hz}}$  and consumes 2.8 mA from supply voltages of 3 V to 10 V. Using the Analog Devices XFCB3 process, the ADA4895-2 has a gain bandwidth product in excess of 1.5 GHz and is gain  $\geq 10$  stable, with an input structure that results in an extremely low input 1/f noise for a relatively high speed amplifier.

The rail-to-rail output stage is designed to drive the heavy feedback load required to achieve an overall low output referred noise. The low input noise and high bandwidth of the ADA4895-2 are achieved with minimal power penalty. For this reason, the maximum offset voltage of 350  $\mu\text{V}$  and voltage drift of 0.15  $\mu\text{V}/^\circ\text{C}$  make the ADA4895-2 an excellent choice, even when the low noise performance of the amplifier is not needed.

For any gain greater than 10, the closed-loop frequency response of a basic noninverting configuration can be approximated by

$$\text{Closed-Loop } -3 \text{ dB Frequency} = (\text{GBP}) \times \frac{R_G}{(R_F + R_G)}$$

For inverting gain configurations, the source impedance must be considered when sizing  $R_G$  to maintain the minimum stable gain. For gains lower than 10, see the Using the ADA4895-2 at a Gain  $< +10$  section, or use the ADA4897-2, which is a unity-gain stable amplifier with 230 MHz bandwidth.

### INPUT PROTECTION

The ADA4895-2 is fully protected from ESD events and can withstand human body model ESD events of 2.5 kV and charged-device model events of 1 kV with no measured performance degradation. The precision input is protected with an ESD network between the power supplies and diode clamps across the input device pair, as shown in Figure 37.

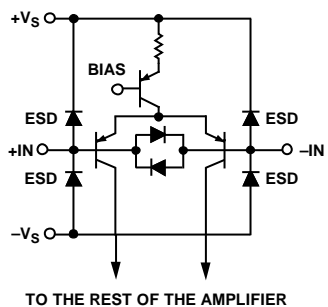

Figure 37. Input Stage and Protection Diodes

At differential voltages above approximately 0.7 V, the diode clamps begin to conduct. Too much current can cause damage due to excessive heating. If large differential voltages must be sustained across the input terminals, it is recommended that the current through the input clamps be limited to less than 10 mA. Series input resistors that are sized appropriately for the expected differential overvoltage provide the needed protection.

The ESD clamps begin to conduct at input voltages that are more than 0.7 V above the positive supply or more than 0.7 V below the negative supply. If an overvoltage condition is expected, it is recommended that the fault current be limited to less than 10 mA.

### DISABLE OPERATION

Figure 38 shows the ADA4895-2 power-down circuitry. If the DISABLEx pin is left unconnected, the base of the input PNP transistor is pulled high through the internal pull-up resistor to the positive supply and the part is turned on. Pulling the DISABLEx pin more than 2 V below the positive supply turns the part off, reducing the supply current to approximately 50  $\mu\text{A}$  for a 5 V voltage supply.

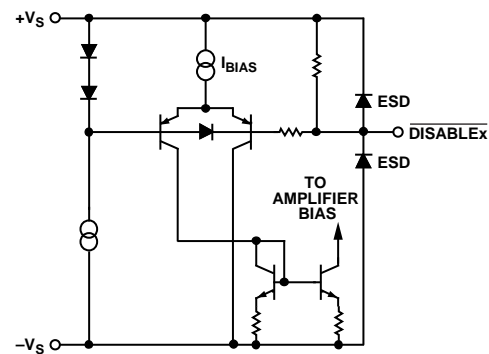

Figure 38. DISABLEx Circuit

The DISABLEx pin is protected by ESD clamps, as shown in Figure 38. Voltages beyond the power supplies cause these diodes to conduct. For protection of the DISABLEx pins, the voltage to these pins should not exceed 0.7 V beyond the supply voltage, or the input current should be restricted to less than 10 mA with a series resistor.

**DC ERRORS**

Figure 39 shows a typical connection diagram and the major dc error sources.

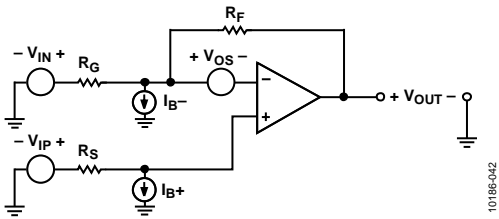

Figure 39. Typical Connection Diagram and DC Error Sources

The ideal transfer function (all error sources set to 0 and infinite dc gain) can be expressed as follows:

$$V_{OUT} = \left(1 + \frac{R_F}{R_G}\right) \times V_{IP} - \left(\frac{R_F}{R_G}\right) \times V_{IN} \quad (1)$$

This equation reduces to the familiar forms for noninverting and inverting op amp gain expressions, as follows:

For noninverting gain ( $V_{IN} = 0$  V),

$$V_{OUT} = \left(1 + \frac{R_F}{R_G}\right) \times V_{IP} \quad (2)$$

For inverting gain ( $V_{IP} = 0$  V),

$$V_{OUT} = \left(\frac{-R_F}{R_G}\right) \times V_{IN} \quad (3)$$

The total output voltage error is the sum of the errors due to the amplifier offset voltage and input currents. The output error due to the offset voltage can be estimated as follows:

$$V_{OUT\_ERROR} = \left( V_{OFFSET\_NOM} + \frac{V_{CM}}{CMRR} + \frac{V_P - V_{PNOM}}{PSRR} + \frac{V_{OUT}}{A} \right) \times \left(1 + \frac{R_F}{R_G}\right) \quad (4)$$

where:

$V_{OFFSET\_NOM}$  is the offset voltage at the specified supply voltage,

which is measured with the input and output at midsupply.

$V_{CM}$  is the common-mode voltage.

$CMRR$  is the common-mode rejection ratio.

$V_P$  is the power supply voltage.

$V_{PNOM}$  is the specified power supply voltage.

$PSRR$  is the power supply rejection ratio.

$A$  is the dc open-loop gain.

The output error due to the input currents can be estimated as follows:

$$V_{OUT\_ERROR} = (R_F || R_G) \times \left(1 + \frac{R_F}{R_G}\right) \times I_{B-} - R_S \times \left(1 + \frac{R_F}{R_G}\right) \times I_{B+} \quad (5)$$

**BIAS CURRENT CANCELLATION**

To cancel the output voltage error due to unmatched bias currents at the inputs, Resistors  $R_{BP}$  and  $R_{BN}$  can be used (see Figure 40).

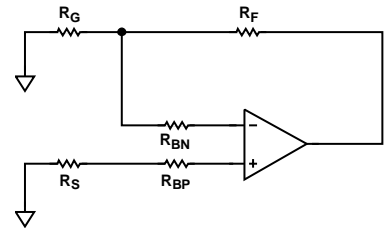

Figure 40. Using  $R_{BP}$  and  $R_{BN}$  to Cancel Bias Current Error

To compensate for the unmatched bias currents at the two inputs, set Resistors  $R_{BP}$  and  $R_{BN}$  as shown in Table 8.

**Table 8. Setting  $R_{BP}$  and  $R_{BN}$  to Cancel Bias Current Error**

| Value of $R_F    R_G$ | Value of $R_{BP}$ ( $\Omega$ ) | Value of $R_{BN}$ ( $\Omega$ ) |
|-----------------------|--------------------------------|--------------------------------|
| Greater Than $R_S$    | $R_F    R_G - R_S$             | 0                              |
| Less Than $R_S$       | 0                              | $R_S - R_F    R_G$             |

**NOISE CONSIDERATIONS**

Figure 41 illustrates the primary noise contributors for the typical gain configurations. The total rms output noise is the root mean square of all the contributions.

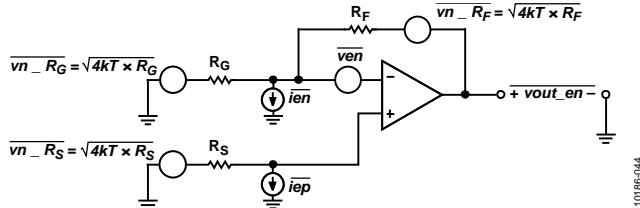

Figure 41. Noise Sources in Typical Gain Configurations

The output noise spectral density can be calculated as follows:

$$v_{out\_en} = \sqrt{4kTR_F + \left(1 + \frac{R_F}{R_G}\right)^2 \left[4kTR_S + i_{ep}^2 R_S^2 + \overline{v_{en}}^2\right] + \left(\frac{R_F}{R_G}\right)^2 4kTR_G + \overline{i_{en}}^2 R_F^2} \tag{6}$$

where:

*k* is Boltzmann’s constant.

*T* is the absolute temperature (degrees Kelvin).

*R<sub>F</sub>* and *R<sub>G</sub>* are the feedback network resistances, as shown in Figure 41.

*R<sub>S</sub>* is the source resistance, as shown in Figure 41.

*i<sub>ep</sub>* and *i<sub>en</sub>* represent the amplifier input current noise spectral density (pA/√Hz).

*v<sub>en</sub>* is the amplifier input voltage noise spectral density (nV/√Hz).

Source resistance noise, amplifier voltage noise (*v<sub>en</sub>*), and the voltage noise from the amplifier current noise (*i<sub>ep</sub>* × *R<sub>S</sub>*) are all subject to the noise gain term (1 + *R<sub>F</sub>*/*R<sub>G</sub>*). Note that with a 1 nV/√Hz input voltage noise and a 2.7 pA/√Hz input current noise, the noise contributions of the amplifier are relatively small for source resistances from approximately 50 Ω to 700 Ω.

Figure 42 shows the total RTI noise due to the amplifier vs. the source resistance. In addition, the value of the feedback resistors used affects the noise. It is recommended that the value of the feedback resistors be maintained between 250 Ω and 1 kΩ to keep the total noise low.

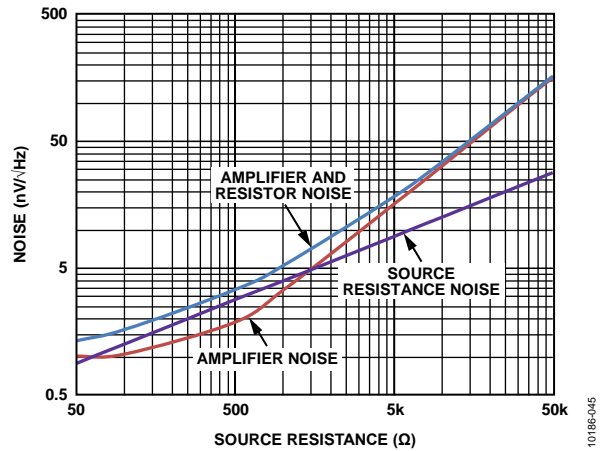

Figure 42. RTI Noise vs. Source Resistance

## APPLICATIONS INFORMATION

### USING THE ADA4895-2 AT A GAIN < +10

The ADA4895-2 is minimum gain 10 stable when used in normal gain configurations. However, the ADA4895-2 can be configured to work at lower gains down to a gain of +5. Figure 43 shows how to add a simple RC circuit ( $R_1 = 49.9 \Omega$  and  $C_1 = 60 \text{ pF}$ ) to allow the ADA4895-2 to operate at a gain of +5.

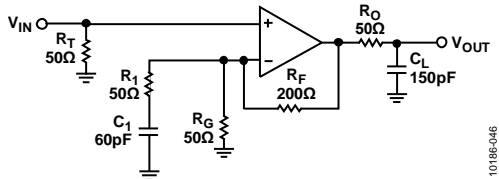

Figure 43. Configuring the ADA4895-2 for a Gain of +5 Stable

This circuit has a gain of 9 at high frequency and a gain of 5 at frequencies lower than the resonance frequency of 53 MHz ( $1/2\pi R_1 C_1$ ). With a noise gain of approximately 9 at high frequency, the total output noise increases unless an antialiasing filter is used to block the high frequency content.

Figure 44 shows the small and large signal frequency response of the circuit shown in Figure 43 into a 50 Ω analyzer ( $G = +5 \text{ V/V}$  or 14 dB). As shown in Figure 44, the circuit is very stable, and the peaking is a little over 2 dB. This configuration is scalable to accommodate any gain from 5 to 10, as shown in Table 9.

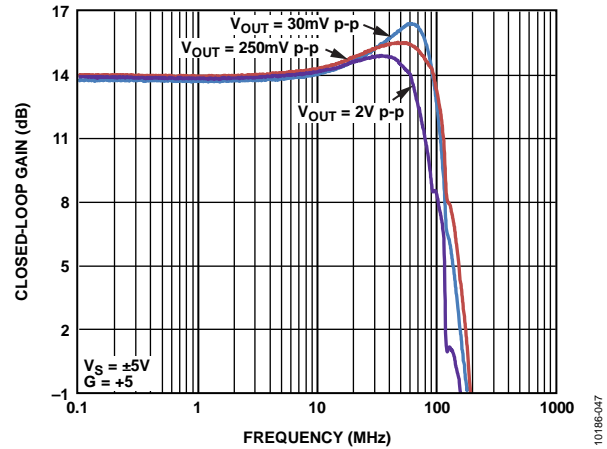

Figure 44. Frequency Response for  $G = +5$

Table 9. Component Values Used with the ADA4895-2 for Gain < +10

| Gain | $R_T (\Omega)$ | $R_1 (\Omega)$ | $C_1 (\text{pF})$ | $R_G (\Omega)$ | $R_F (\Omega)$ | $R_O (\Omega)$ | $C_L (\text{pF})$ |
|------|----------------|----------------|-------------------|----------------|----------------|----------------|-------------------|
| +5   | 49.9           | 49.9           | 60                | 49.9           | 200            | 49.9           | 150               |
| +6   | 49.9           | 66.5           | 45                | 40.2           | 200            | 49.9           | 150               |
| +7   | 49.9           | 110            | 27                | 37.4           | 226            | 49.9           | 150               |
| +8   | 49.9           | 205            | 15                | 32.4           | 226            | 49.9           | 120               |
| +9   | 49.9           | NA             | NA                | 30.9           | 249            | 49.9           | 100               |

### HIGH GAIN BANDWIDTH APPLICATION

The circuit in Figure 45 shows cascaded dual amplifier stages using the ADA4895-2. Each stage has a gain of +10 (+20 dB), making the output 100 times (+40 dB) the input. The total gain bandwidth product is approximately 9 GHz with the part operating on 6 mA of quiescent current (3 mA per amplifier).

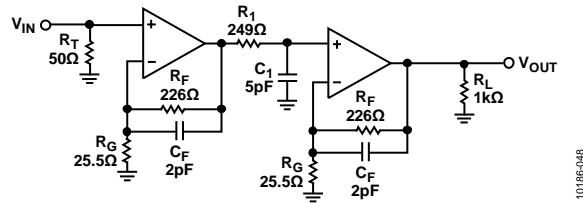

Figure 45. Cascaded Amplifier Stages for High Gain Applications ( $G = +100$ )

Figure 46 shows the large signal frequency response for two cases. The first case is with installed feedback capacitors ( $C_F = 2\text{ pF}$ ), and the second case is without these capacitors. Removing the 2 pF feedback capacitors from this circuit increases the bandwidth, but adds about 0.5 dB of peaking.

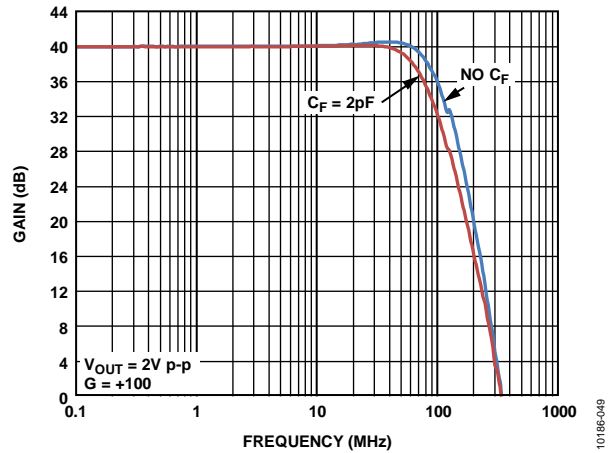

Figure 46. Large Signal Frequency Response,  $G = +100$ ,  $V_S = \pm 5\text{ V}$

To better balance the second stage and remove the current offset contribution, an  $R_1C_1$  circuit can be sized to correct for any mismatch between the source impedance and the feedback network impedance on the input amplifier. (In the example shown in Figure 45,  $R_1 = 249\ \Omega$  and  $C_1 = 5\text{ pF}$ .) The offset of each amplifier is within the same statistical range. As configured, the offset of the output amplifier is not statistically significant to the overall offset of the system.

Figure 46 was captured using a  $\pm 5\text{ V}$  supply; however, this circuit will also operate with supplies from  $\pm 1.5\text{ V}$  to  $\pm 5\text{ V}$  as long as the input and output headroom values are not violated.

**WIDEBAND PHOTOMULTIPLIER PREAMPLIFIER**

A decompensated amplifier can provide significantly greater speed in transimpedance applications than a unity-gain stable amplifier. The speed increases by the square root of the ratio of the two amplifiers' bandwidth; that is, a 1 GHz GBP amplifier is 10 times faster than a 10 MHz amplifier in the same transimpedance application if all other parameters are kept constant. Additionally, the input voltage noise normally dominates the total output rms noise because it is multiplied by the capacitive noise gain network.

$$\frac{(C_S + C_M + C_F + C_D)}{C_F}$$

In the case of the ADA4895-2, the input noise is low, but the capacitive noise gain network must be kept greater than 10 for stability reasons.

One disadvantage of using the ADA4895-2 in transimpedance applications is that the input current and input current noise can create large offsets and output voltage noise when coupled with an excessively high feedback resistance. Despite these two issues, the ADA4895-2 noise and gain bandwidth can provide a significant increase in performance within certain transimpedance ranges.

Figure 47 shows an I/V converter with an electrical model of a photomultiplier.

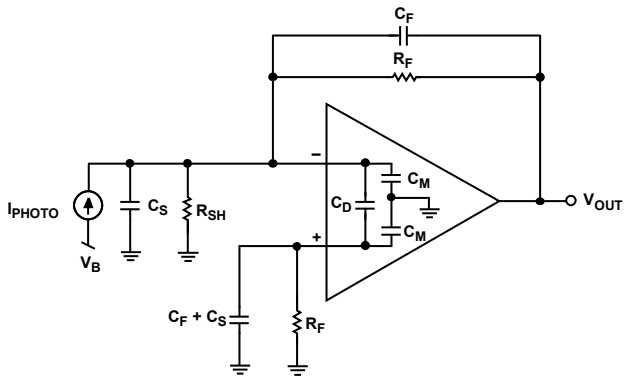

Figure 47. Wideband Photomultiplier Preamplifier

The basic transfer function is

$$V_{OUT} = \frac{I_{PHOTO} \times R_F}{1 + sC_F R_F}$$

where  $I_{PHOTO}$  is the output current of the photomultiplier, and the parallel combination of  $R_F$  and  $C_F$  sets the signal bandwidth.

The stable bandwidth attainable with this preamplifier is a function of  $R_F$ , the gain bandwidth product of the amplifier, and the total capacitance at the summing junction of the amplifier, including  $C_S$  and the amplifier input capacitance.

$R_F$  and the total capacitance produce a pole in the loop transmission of the amplifier that can result in peaking and instability. Adding  $C_F$  creates a zero in the loop transmission that compensates for the pole effect and reduces the signal bandwidth. It can be shown that the signal bandwidth resulting in a 45° phase margin ( $f_{(45)}$ ) is defined as follows:

$$f_{(45)} = \sqrt{\frac{GBP}{2\pi \times R_F \times C_S}}$$

where:

$GBP$  is the gain bandwidth product.

$R_F$  is the feedback resistance.

$C_S$  is the total capacitance at the amplifier summing junction (amplifier + photomultiplier + board parasitics).

The value of  $C_F$  that produces  $f_{(45)}$  is

$$C_F = \sqrt{\frac{C_S}{2\pi \times R_F \times GBP}}$$

The frequency response in this case shows approximately 2 dB of peaking and 15% overshoot. Doubling  $C_F$  and reducing the bandwidth by half results in a flat frequency response with approximately 5% transient overshoot.

The output noise over frequency for the preamplifier is shown in Figure 48.

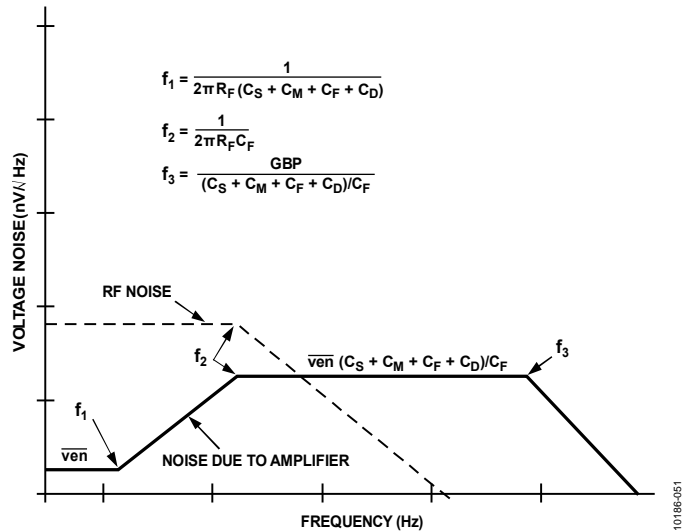

Figure 48. Photomultiplier Voltage Noise Contributions

**Table 10. RMS Noise Contributions of Photomultiplier Preamplifier**

| Contributor                   | Expression   |
|-------------------------------|--|
| $R_F$                         | $\sqrt{4kT \times R_F \times f_2 \times 1.57}$   |
| Amplifier $\overline{v_{en}}$ | $\frac{\overline{v_{en}}}{C_F} \times \frac{(C_S + C_M + C_F + C_D)}{C_F} \times \sqrt{f_3 \times 1.57}$ |
| Amplifier $\overline{i_{en}}$ | $\overline{i_{en}} \times R_F \times \sqrt{f_2 \times 1.57}$   |

## LAYOUT CONSIDERATIONS

To ensure optimal performance, careful and deliberate attention must be paid to the board layout, signal routing, power supply bypassing, and grounding.

### **Ground Plane**

It is important to avoid ground in the areas under and around the input and output of the [ADA4895-2](#). Stray capacitance created between the ground plane and the input and output pads of a device is detrimental to high speed amplifier performance. Stray capacitance at the inverting input, along with the amplifier input capacitance, lowers the phase margin and can cause instability. Stray capacitance at the output creates a pole in the feedback loop, which can reduce phase margin and can cause the circuit to become unstable.

### **Power Supply Bypassing**

Power supply bypassing is a critical aspect in the performance of the [ADA4895-2](#). A parallel connection of capacitors from each power supply pin to ground works best. Smaller value capacitor electrolytics offer better high frequency response, whereas larger value capacitor electrolytics offer better low frequency performance.

Paralleling different values and sizes of capacitors helps to ensure that the power supply pins are provided with low ac impedance across a wide band of frequencies. This is important for minimizing the coupling of noise into the amplifier—especially when the amplifier PSRR begins to roll off—because the bypass capacitors can help lessen the degradation in PSRR performance.

Place the smallest value capacitor on the same side of the board as the amplifier and as close as possible to the amplifier power supply pins. Connect the ground end of the capacitor directly to the ground plane.

It is recommended that a 0.1  $\mu\text{F}$  ceramic capacitor with a 0508 case size be used. The 0508 case size offers low series inductance and excellent high frequency performance. Place a 10  $\mu\text{F}$  electrolytic capacitor in parallel with the 0.1  $\mu\text{F}$  capacitor. Depending on the circuit parameters, some enhancement to performance can be realized by adding additional capacitors. Each circuit is different and should be analyzed individually for optimal performance.

OUTLINE DIMENSIONS

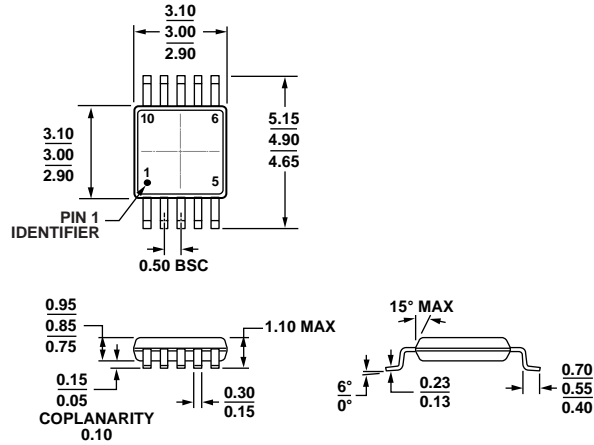

COMPLIANT TO JEDEC STANDARDS MO-187-BA  
 Figure 49. 10-Lead Mini Small Outline Package [MSOP] (RM-10)  
 Dimensions shown in millimeters

081709-A

ORDERING GUIDE

| Model <sup>1</sup> | Temperature Range | Package Description                       | Package Option | Ordering Quantity | Branding |
|--------------------|-------------------|---|----------------|-------------------|----------|
| ADA4895-2ARMZ      | -40°C to +125°C   | 10-Lead Mini Small Outline Package [MSOP] | RM-10          | 50                | H35      |
| ADA4895-2ARMZ-R7   | -40°C to +125°C   | 10-Lead Mini Small Outline Package [MSOP] | RM-10          | 1,000             | H35      |
| ADA4895-2ARMZ-RL   | -40°C to +125°C   | 10-Lead Mini Small Outline Package [MSOP] | RM-10          | 3,000             | H35      |
| ADA4895-2ARM-EBZ   |                   | Evaluation Board                          |                |                   |          |

<sup>1</sup> Z = RoHS Compliant Part.