

## CDSER4148-HF

RoHS Device  
Halogen Free

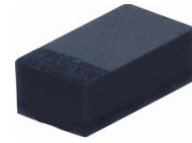

### Features

- High Speed.
- Designed for mounting on small surface.
- Extremely thin/leadless package.
- High mounting capability, strong surge withstand, high reliability.
- Use in sensitive electronics protection against voltage transients induced by inductive load switching and lighting on ICs, MOSFET, signal lines of sensor units for consumer, computer, industrial, automotive and telecommunication.

### Mechanical data

- Case: 0503/SOD-723F standard package, molded plastic.
- Terminals: Gold plated, solderable per MIL-STD-750, method 2026.
- Polarity: Indicated by cathode band.
- Mounting position: Any
- Weight: 0.002 gram(approx.).

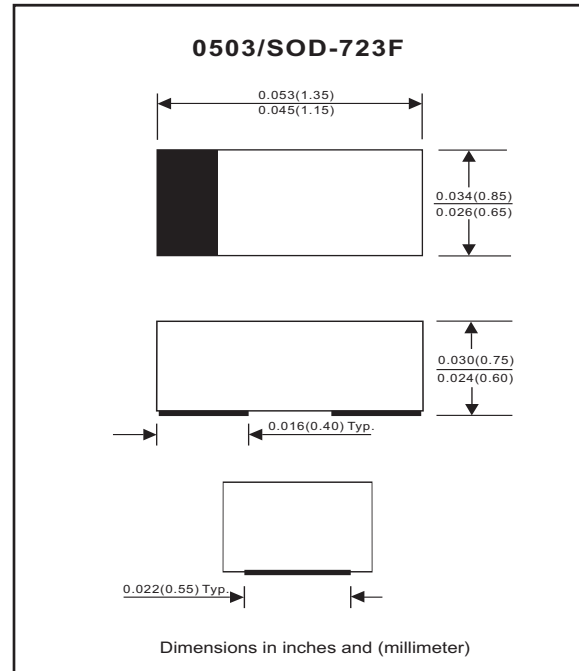

### Maximum Rating (at TA=25°C unless otherwise noted)

Parameter	Conditions	Symbol	Min	Typ	Max	Unit
Repetitive peak reverse voltage		V <sub>RRM</sub>			100	V
Reverse voltage		V <sub>R</sub>			75	V
Average forward current		I <sub>O</sub>			150	mA
Forward current, surge peak	T <sub>P</sub> = 1μS T <sub>P</sub> = 1mS	I <sub>FSM</sub>		4 1		A
Repetitive peak forward current		I <sub>FRM</sub>			300	mA
Power Dissipation		P <sub>D</sub>			150	mW
Storage temperature		T <sub>STG</sub>	-40		+125	°C
Junction temperature		T <sub>J</sub>			+125	°C

### Electrical Characteristics (at TA=25°C unless otherwise noted)

Parameter	Conditions	Symbol	Min	Typ	Max	Unit
Forward voltage	I <sub>F</sub> = 50 mA DC	V <sub>F</sub>			1.0	V
Reverse current	V <sub>R</sub> = 20 V V <sub>R</sub> = 75 V	I <sub>R</sub>			25 2.5	nA uA
Capacitance between terminals	f = 1 MHz, and 0VDC reverse voltage	C <sub>T</sub>			4	pF
Reverse recovery time	I <sub>F</sub> = I <sub>R</sub> = 10 mA, R <sub>L</sub> = 100 ohms, I <sub>rr</sub> = 1 mA	T <sub>rr</sub>			4	nS

## RATING AND CHARACTERISTIC CURVES (CDSER4148-HF)

Fig. 1 - Forward characteristics

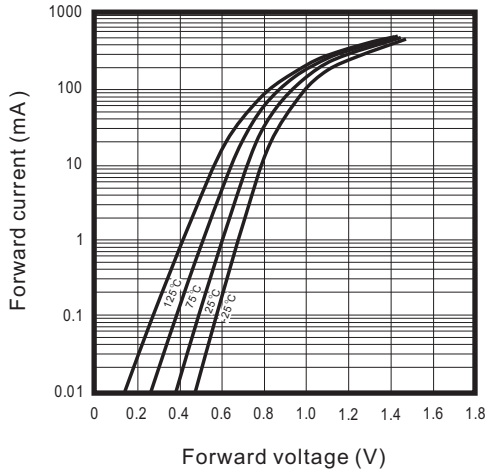

Fig. 2 - Reverse characteristics

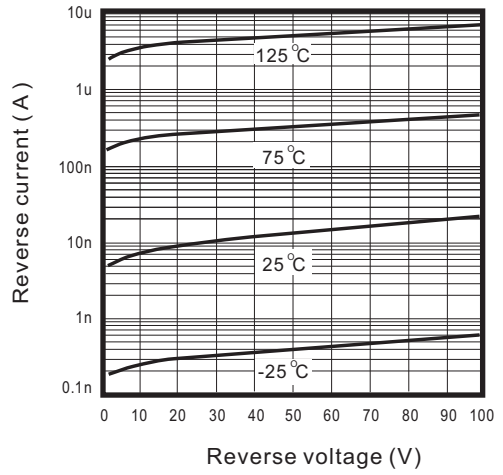

Fig. 3 - Capacitance between terminals characteristics

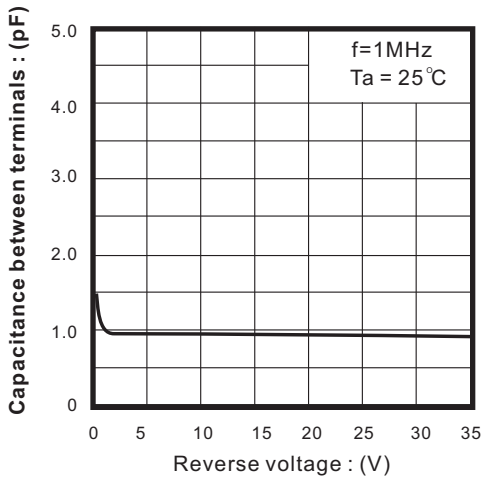
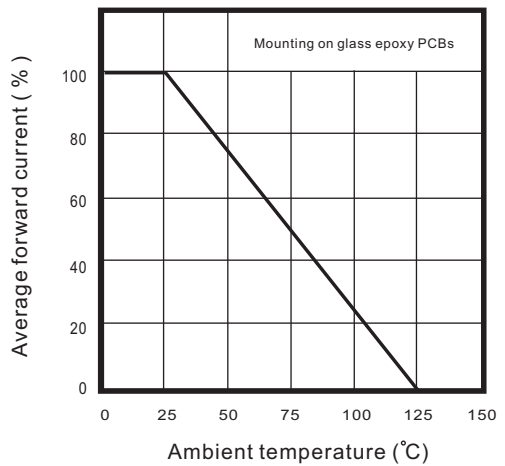
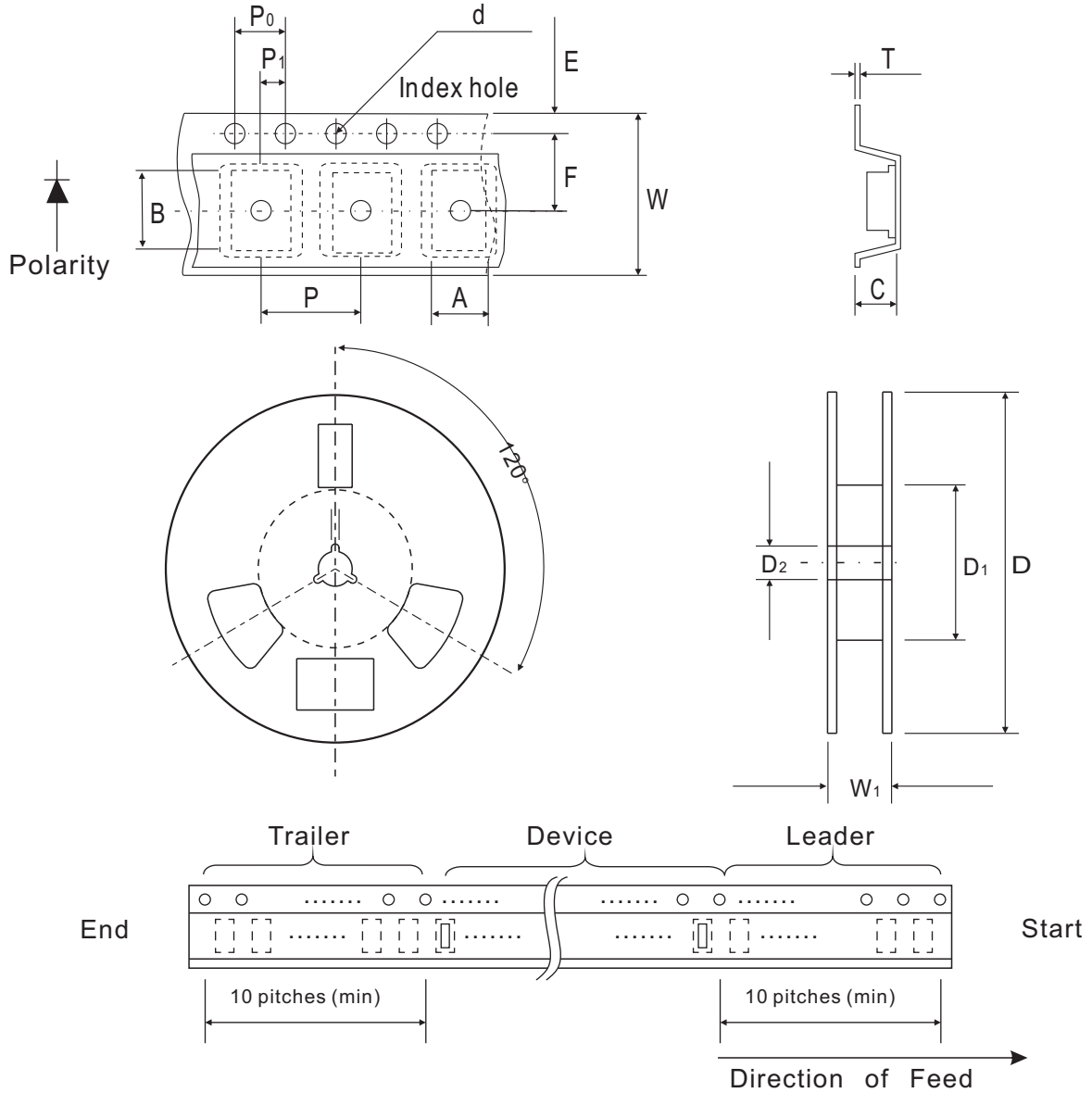

Fig. 4 - Current derating curve



## Reel Taping Specification



0503 (SOD-723F)	SYMBOL	A	B	C	d	D	D <sub>1</sub>	D <sub>2</sub>
	(mm)	0.90 ± 0.10	1.46 ± 0.10	0.80 ± 0.10	1.55 ± 0.05	178 ± 1	60.0 MIN.	13.0 ± 0.20
	(inch)	0.035 ± 0.004	0.057 ± 0.004	0.031 ± 0.004	0.061 ± 0.002	7.008 ± 0.04	2.362 MIN.	0.512 ± 0.008

0503 (SOD-723F)	SYMBOL	E	F	P	P <sub>0</sub>	P <sub>1</sub>	T	W	W <sub>1</sub>
	(mm)	1.75 ± 0.10	3.50 ± 0.05	4.00 ± 0.10	4.00 ± 0.10	2.00 ± 0.10	0.22 ± 0.05	8.00 ± 0.20	13.5 MAX.
	(inch)	0.069 ± 0.004	0.138 ± 0.002	0.157 ± 0.004	0.157 ± 0.004	0.079 ± 0.004	0.008 ± 0.002	0.315 ± 0.008	0.531 MAX.

## Marking Code

Part Number	Marking Code
CDSER4148-HF	S3



## Suggested PAD Layout

SIZE	0503/SOD-723F	
	(mm)	(inch)
A	0.85	0.033
B	0.55	0.022
C	0.85	0.033
D	1.40	0.055
E	0.30	0.012

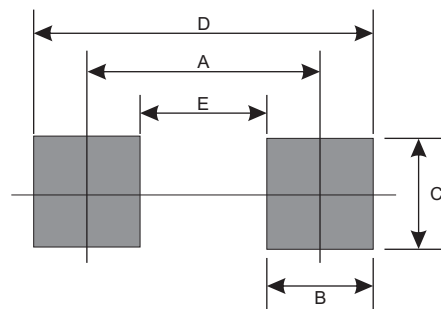

## Standard Package

Case Type	Qty per Reel	Reel Size
	(Pcs)	(inch)
0503/SOD-723F	4000	7