

## Ultra High Precision Foil Wraparound Surface Mount Chip Resistor with Extended Pads for High Power/High Temperature Applications up to +225°C, Load Life Stability of 0.05% ,TCR to ± 1ppm/°C

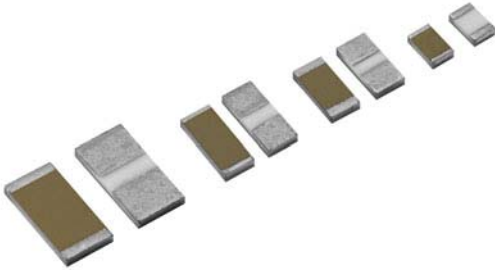

### INTRODUCTION

Vishay Foil Resistors (VFR) introduces a new line of Ultra Precision Bulk Metal® Z1-Foil technology: wraparound surface mount chip resistors with extended pads for high temperature up to + 225 °C<sup>(1)</sup> (working power: to 330mW at +200 °C).

The new extended pad designs also exhibit better heat dissipation, thus enabling higher power usage (Working Power: to 1200mW at + 70°C <sup>(1)</sup>). The FRSH has a full wraparound termination that ensures safe handling during the manufacturing process, as well as providing stability during multiple thermal cyclings.

The FRSH is available in any value within the specified resistance range. VFR's application engineering department is available to advise and make recommendations. For non-standard technical requirements and special applications, please contact [foil@vishaypg.com](mailto:foil@vishaypg.com).

TABLE 1 - TOLERANCE AND TCR VS. RESISTANCE VALUE <sup>(1)(2)</sup> (- 55 °C to + 200 °C, + 25 °C Ref.)		
RESISTANCE VALUE (Ω)	TOLERANCE (%)	TCR Typical (ppm/°C)
250 to 125K	± 0.01	±2.5
100 to < 250	± 0.02	
50 to < 100	± 0.05	
25 to < 50	± 0.1	
10 to < 25	± 0.25	

#### Note

- <sup>(1)</sup> Performances obtained with ceramic PCB.  
<sup>(2)</sup> For tighter performances and non-standard values up to 150 kΩ, please contact VFR's application engineering department by sending an e-mail to the address in the footer below.

### FEATURES

- Temperature coefficient of resistance (TCR):  
 ±1 ppm/°C typical (- 55 °C to + 125 °C, + 25 °C ref.)  
 ±2.5 ppm/°C typical (- 55 °C to + 200 °C, + 25 °C ref.)
- Resistance range: 10 Ω to 125 kΩ (for higher and lower values, please contact VFR's application engineering department)
- Resistance tolerance: to ± 0.01 %
- Working power<sup>(1)</sup>: to 1200mW at + 70 °C;  
 to 330mW at + 200 °C
- Long term stability: to ± 0.05 % at + 225 °C for 2000h, no power
- Load life stability: to ± 0.05 % at + 200 °C for 2000h, at working power
- Vishay Foil resistors are not restricted to standard values; specific "as required" values can be supplied at no extra cost or delivery (e.g. 1K2345 vs. 1K)
- Thermal stabilization time < 1 s (nominal value achieved within 10 ppm of steady state value)
- Electrostatic discharge (ESD) at least to 25 kV
- Non inductive, non capacitive design
- Rise time: 1 ns effectively no ringing
- Current noise: 0.010 μV (RMS)/Volt of applied voltage (< - 40 dB)
- Voltage coefficient: < 0.1 ppm/V
- Non inductive: < 0.08 μH
- Non hot spot design
- Terminal finishes available:  
 High temperature solder
- Matched sets are available on request
- Prototype quantities available in just 5 working days or sooner. For more information, please contact [foil@vishaypg.com](mailto:foil@vishaypg.com)

FIGURE 1 - POWER DERATING CURVE

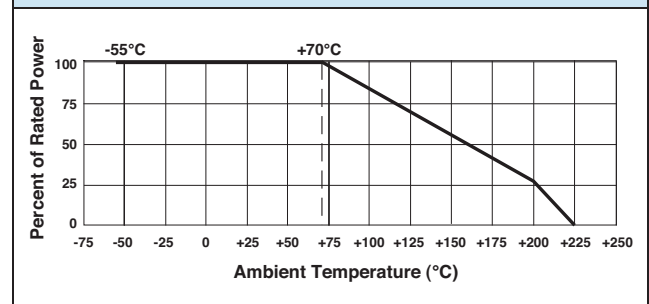

### HIGH TEMPERATURE PRODUCTS

Resistors are the passive building blocks of an electrical circuit. They may be used for dropping the voltage, buffering the surge when the circuit is turned on, providing feedback in a monitoring loop, sensing current flow, etc. When the application requires stability over time and load, initial accuracy, minimal change with temperature for more than 200 °C, resistance to moisture and a number of other characteristics that will be described below, only the new generation of Vishay Foil Resistors have the attributes needed for such application. Over the past few months, there has been considerable growth in the demand for precise, stable and reliable resistors that can operate in harsh environments and especially at high temperatures to 220 °C. Many analog circuits for industrial, military, aerospace, medical, down-hole, oil well and automotive applications require passive components such as resistors to have a minimal drift from their initial values when operating above + 175 °C and in humid environments. In these applications, the most important factor is the temperature dependence and the end of life tolerance (which is part of the stability) and to a lesser extent, the initial tolerance.

The new Vishay Foil resistors provide stabilities well under the maximum allowable drift required by customers' specifications through thousands of hours of operation under harsh conditions, such as the extreme temperatures and radiation-rich environments of down-hole oil-well logging applications, in the frigid arctic, under the sea or in deep space. All Bulk Metal<sup>®</sup> Foil resistors receive stabilization processing, such as repetitive short term power overloads, to assure reliable service through the unpredictable stresses of extreme operation. Compared to Bulk Metal<sup>®</sup> Foil, thick and thin film resistor elements are produced with a non-controllable material. Heat or mechanical stresses on the resistive elements cause the particles forming the film to expand. However, after these stresses are alleviated, the particles in the film matrix do not return to the exact original position. That degenerates their overall stability.

Vishay Foil Resistors' Ultra High Precision Bulk Metal<sup>®</sup> Foil technology includes many types of resistors with a variety of standard configurations that can withstand unconventional environmental conditions above and below the earth's surface using special post manufacturing operations specially developed for this purpose. The stability of a resistor depends primarily on its history of exposures to high temperature. Stability is affected by:

1. Changes in the ambient temperature and heat from adjacent components (defined by the Temperature Coefficient of Resistance, or TCR)
2. Destabilizing thermal shock of suddenly-applied power (defined by the Power Coefficient of Resistance, or PCR)
3. Long-term exposure to applied power (load-life stability)
4. Repetitive stresses from being switched on and off

In very high-precision resistors that need to operate in an environment with temperatures above + 175 °C, these effects must be taken into account to achieve high stability with changes in load (Joule Effect) and ambient temperature.

The Bulk Metal<sup>®</sup> Foil Resistors' new Z1-Foil technology provides an order of magnitude reduction in the Bulk Metal<sup>®</sup> Foil element's sensitivity to temperature changes — both external and internal – with emphasis on long term stability in high temperature environments.

In order to take full advantage of the low TCR and long term stability improvement, it is necessary to take into account the differences in the resistor's response to each of the above-mentioned effects. As described below, new products have been developed to successfully deal with these factors. For high temperature applications where stability and total error budget is the main concern, the new generation of Vishay Foil resistors offers the best resilience against time at elevated temperature.

The new Vishay Foil technology allows us to produce customer-oriented products designed to satisfy unique and specific technical requirements. In addition to the special chip stabilization under extreme environment conditions in the production line, we offer additional specially oriented post manufacturing operations (PMO) for high temperature applications that require an even higher degree of reliability and stability.

Electrostatic Discharge (ESD) is another potential problem that can cause unpredictable failure in high temperature applications that increase the sensitivity of the resistors to ESD.

ESD damage to electronic devices can occur at any point in the device's life cycle, from manufacturing to field service. A resistor that is exposed to an ESD event may fail immediately or may experience a latent defect. With latent defects, premature failure can occur after the resistor is already functioning in the finished product after an unpredictable length of service. Bulk Metal<sup>®</sup> Foil resistors are capable of withstanding electrostatic discharges at least to 25 kV without degradation.

VFR's Application Engineering department is always available to assist with any special requirements you might have. If you are not sure which resistor best suits your needs, please do not hesitate to contact them for more information: [Foil@vishaypg.com](mailto:Foil@vishaypg.com)

**FIGURE 2 - TRIMMING TO VALUES**  
(Conceptual Illustration)

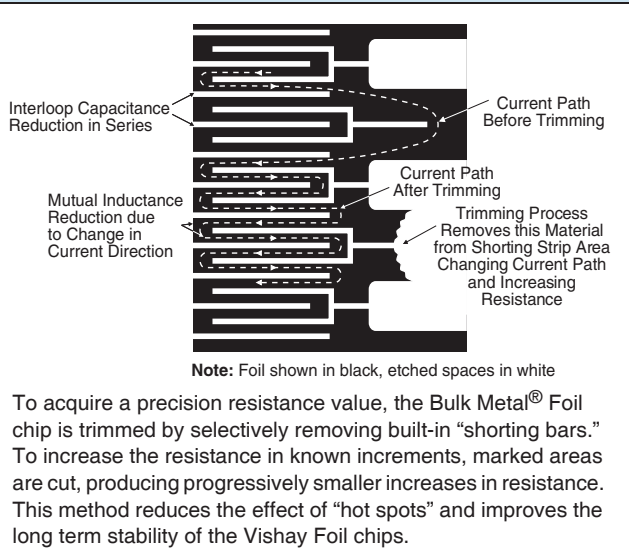

**TABLE 4 - SPECIFICATIONS<sup>(1)</sup>**

CHIP SIZE	RATED POWER (mW) at + 70°C	WORKING POWER (mW) at + 200 °C*	RESISTANCE RANGE (Ω)
0603	120	33	100 to 4K
0805	300	83	10 to 8K
1206	500	140	10 to 25K
1506	600	167	10 to 30K
2010	800	220	10 to 70K
2512	1200	330	10 to 125K

**Note**  
\* Maximum working voltage for a given resistance value is calculated using  $V = \sqrt{P \times R}$ .

**TABLE 2- DIMENSIONS AND LAND PATTERN in Inches (Millimeters)**

CHIP SIZE	L ± 0.005 (0.13)	W ± 0.005 (0.13)	THICKNESS MAXIMUM	D ± 0.005 (0.13)	Z	G	X
0603	0.063 (1.60)	0.032(0.81)	0.025 (0.64)	0.011 (0.28)	0.102 (2.59)	0.031 (0.78)	0.031 (0.78)
0805	0.080 (2.03)	0.050 (1.27)	0.025 (0.64)	0.015 (0.38)	0.122 (3.10)	0.028 (0.71)	0.050 (1.27)
1206	0.126 (3.20)	0.062 (1.57)	0.025 (0.64)	0.035 (0.89)	0.175 (4.45)	0.029 (0.74)	0.071 (1.80)
1506	0.150 (3.81)	0.062 (1.57)	0.025 (0.64)	0.047 (1.20)	0.199 (5.05)	0.029 (0.74)	0.071 (1.80)
2010	0.198 (5.03)	0.097 (2.46)	0.025 (0.64)	0.071 (1.82)	0.247 (6.27)	0.029 (0.74)	0.103 (2.62)
2512	0.249 (6.32)	0.127 (3.23)	0.025 (0.64)	0.095 (2.43)	0.291 (7.39)	0.029 (0.74)	0.127 (3.23)

\* For 0603 and 0805 land pattern dimensions are per IPC-782

**TABLE 3 - COMPARATIVE PERFORMANCES<sup>(2)</sup> - THIN FILM VS. BULK METAL® Z1-FOIL TECHNOLOGY**

TEST OR CONDITIONS	ΔR LIMITS OF THIN FILM (TYPICAL)	ΔR LIMITS OF BULK METAL® Z1-FOIL TECHNOLOGY - FRSH SERIES <sup>(1)</sup> (TYPICAL)
Thermal Shock, 5 x (- 65 °C to + 200 °C)	± 0.1 %	± 0.05% (500 ppm)
Low Temperature Operation, - 65 °C, 45 min at Rated Power	± 0.1 %	± 0.0025% (25 ppm)
Moisture Resistance	± 0.1 %	± 0.003% (30 ppm)
Load Life Stability, + 200 °C for 2000 h at Working Power (see table 4)	± 0.5 %	± 0.05% (500 ppm)
Long term stability, + 225 °C for 2000h, no power.	± 0.5 %	± 0.05 % (500 ppm)

**Notes**

- (1) Performances obtained with ceramic PCB.
- (2) As shown + 0.01 Ω to allow for measurement errors at low values.

### FIGURE 3 - RECOMMENDED MOUNTING

**Notes**

- (1) IR and vapor phase reflow are recommended.
- (2) Avoid the use of cleaning agents which could attack epoxy resins, which form part of the resistor construction
- (3) Vacuum pick up is recommended for handling
- (4) In case of using soldering iron, measurement precautions should be taken to avoid damaging the resistor

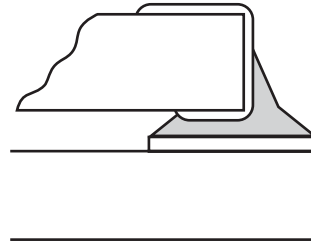

### PULSE TEST

**TEST DESCRIPTION**

All parts baked at +125°C for 1 hour and allowed to cool at room temperature for 1 hour, prior to testing. By using an electrolytic 0.01µF capacitor charged to 1200 VDC, a single pulse was performed on 30 units of 1206, 10KΩ of Surface Mount Vishay Foil resistor and Thin Film resistor. The unit was allowed time to cool down, after which the resistance measurement was taken and displayed in ppm deviation from the initial reading.

### FIGURE 4 - PULSE TEST DESCRIPTION

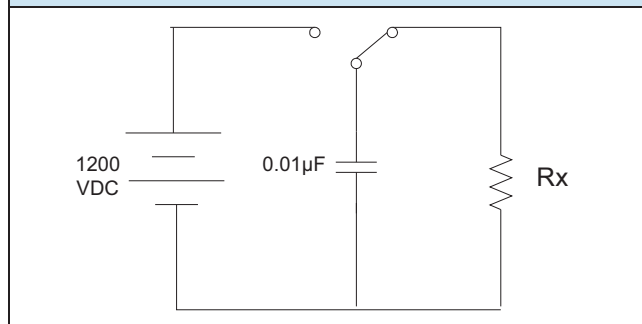

**TEST RESULTS**

### FIGURE 5 - PULSE TEST RESULTS AT 1200 VDC\*

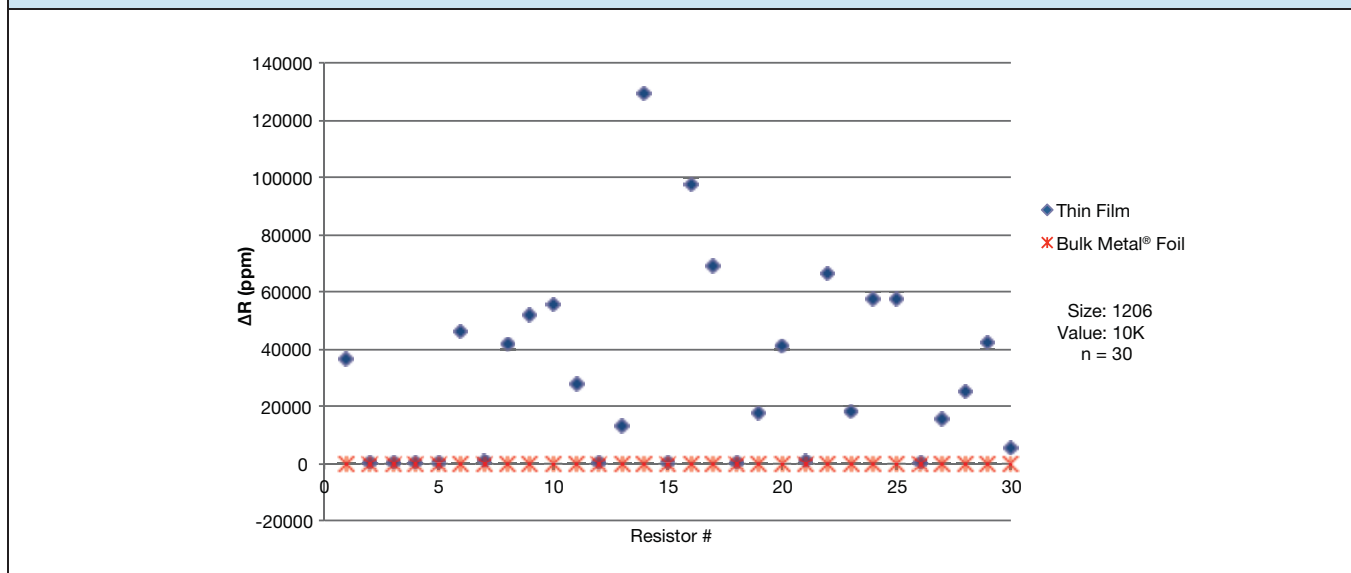

\*Note: Average of 30 units yielded deviation of 30,723 ppm of the thin film vs. -14 ppm for the Bulk Metal® Foil

## ELECTROSTATIC DISCHARGE (ESD)

ESD can be categorized into three types of damages

**Parametric Failure** - occurs when the ESD event alters one or more device parameters (resistance in the case of resistors), causing it to shift from its required tolerance. This failure does not directly pertain to functionality; thus a parametric failure may be present while the device is still functional.

**Catastrophic Damage** - occurs when the ESD event causes the device to immediately stop functioning. This may occur after one or a number of ESD events with diverse causes, such as human body discharge or the mere presence of an electrostatic field.

**Latent Damage** - occurs when the ESD event causes moderate damage to the device, which is not noticeable, as the device appears to be functioning correctly. However, the load life of the device has been dramatically reduced, and further degradation caused by operating stresses may cause the device to fail during service. Latent damage is the source for greatest concern, since it is very difficult to detect by re-measurement or by visual inspection, since damage may have occurred under the external coating.

### TEST DESCRIPTION

By using an electrolytic 500 pF capacitor charged up to 4500 V, pulses were performed on groups of 10 units of 1206, 10 kΩ of three different Surface Mount Chip Resistors technologies, with an initial voltage spike of 2500 V (Figure 6). The unit was allowed time to cool down, after which the resistance measurement was taken and displayed in ppm deviation from the initial reading. Readings were then taken in 500 V increments up to 4500 V. Table 5 shows the maximum drift in each group.

**New** - For live demonstration of ESD pulses, please visit our new video landing page: <http://www.vishaypg.com/foil-resistors/videos/>

### TEST RESULTS

**FIGURE 6 - ESD TEST DESCRIPTION**

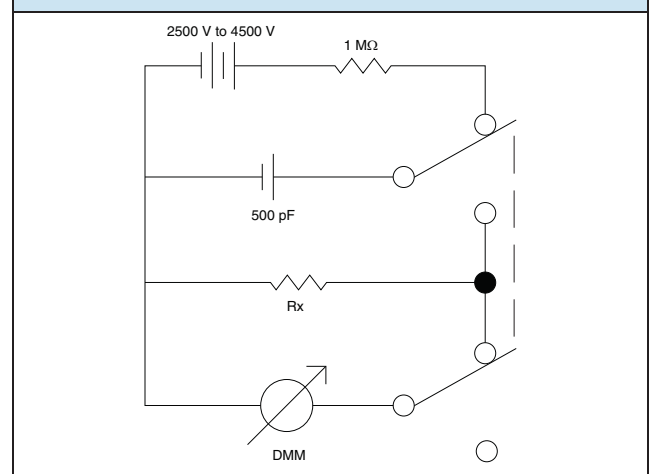
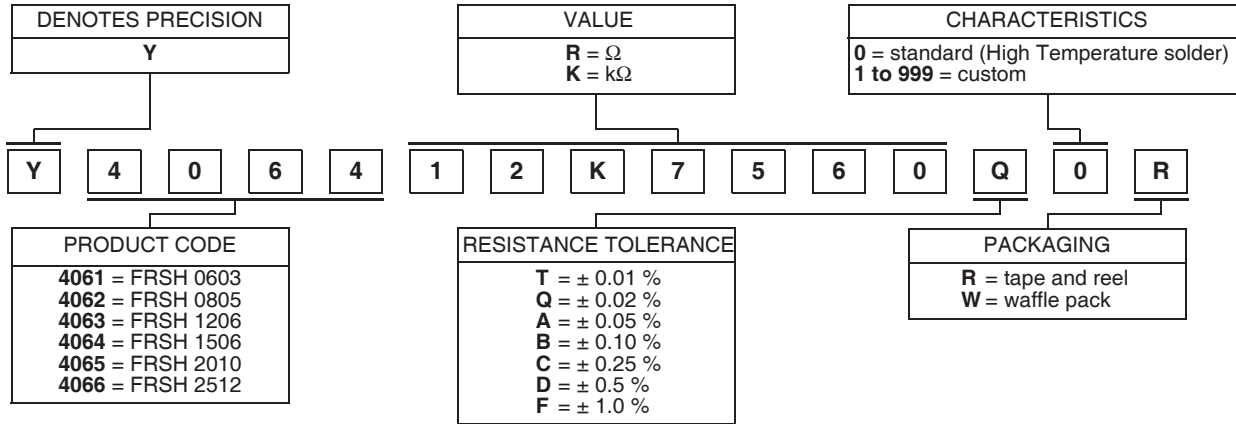

**TABLE 5 - ESD TEST RESULTS**

VOLTS	ΔR (%)		
	THICK FILM	THIN FILM	FOIL
2500	-2.7	97	<0.005
3000	-4.2	366	<0.005
3500	-6.2	>5000	<0.005
4000	-7.4	>5000	<0.005
4500	-8.6	OPEN	<0.005

**TABLE 6 - GLOBAL PART NUMBER INFORMATION (1)**

NEW GLOBAL PART NUMBER: Y406412K7560Q0R (preferred part number format)



FOR EXAMPLE: ABOVE GLOBAL ORDER Y4064 12K7560 Q 0 R:

TYPE: FRSH1506  
 VALUES: 12.7560  $k\Omega$   
 ABSOLUTE TOLERANCE: 0.02 %  
 TERMINATION: Standard  
 PACKAGING: tape and reel

HISTORICAL PART NUMBER: FRSH1506 12K756 TCR2.5 Q B T (will continue to be used)

<b>FRSH1506</b>	<b>12K756</b>	<b>TCR2.5</b>	<b>Q</b>	<b>B</b>	<b>T</b>
MODEL	RESISTANCE VALUE	TCR CHARACTERISTICS	TOLERANCE	TERMINATION	PACKAGING
FRSH 0603 FRSH 0805 FRSH 1206 FRSH 1506 FRSH 2010 FRSH 2512	12.756 $k\Omega$		T = $\pm 0.01\%$ Q = $\pm 0.02\%$ A = $\pm 0.05\%$ B = $\pm 0.10\%$ C = $\pm 0.25\%$ D = $\pm 0.5\%$ F = $\pm 1.0\%$	B = Standard	T = tape and reel W = waffle pack

**Note**

(1) For non-standard requests, please contact application engineering.

## Disclaimer

ALL PRODUCTS, PRODUCT SPECIFICATIONS AND DATA ARE SUBJECT TO CHANGE WITHOUT NOTICE.

Vishay Precision Group, Inc., its affiliates, agents, and employees, and all persons acting on its or their behalf (collectively, "Vishay Precision Group"), disclaim any and all liability for any errors, inaccuracies or incompleteness contained herein or in any other disclosure relating to any product.

The product specifications do not expand or otherwise modify Vishay Precision Group's terms and conditions of purchase, including but not limited to, the warranty expressed therein.

Vishay Precision Group makes no warranty, representation or guarantee other than as set forth in the terms and conditions of purchase. **To the maximum extent permitted by applicable law, Vishay Precision Group disclaims (i) any and all liability arising out of the application or use of any product, (ii) any and all liability, including without limitation special, consequential or incidental damages, and (iii) any and all implied warranties, including warranties of fitness for particular purpose, non-infringement and merchantability.**

Information provided in datasheets and/or specifications may vary from actual results in different applications and performance may vary over time. Statements regarding the suitability of products for certain types of applications are based on Vishay Precision Group's knowledge of typical requirements that are often placed on Vishay Precision Group products. It is the customer's responsibility to validate that a particular product with the properties described in the product specification is suitable for use in a particular application.

No license, express, implied, or otherwise, to any intellectual property rights is granted by this document, or by any conduct of Vishay Precision Group.

The products shown herein are not designed for use in life-saving or life-sustaining applications unless otherwise expressly indicated. Customers using or selling Vishay Precision Group products not expressly indicated for use in such applications do so entirely at their own risk and agree to fully indemnify Vishay Precision Group for any damages arising or resulting from such use or sale. Please contact authorized Vishay Precision Group personnel to obtain written terms and conditions regarding products designed for such applications.

Product names and markings noted herein may be trademarks of their respective owners.