

# Surface Mounting Chip LED

## Side View Type

Global Part No.	Conventional Part No.	Lighting Color
LNJ210C6RRA	LNJ210C6RRA	Red
LNJ210C6ARA	LNJ210C6ARA	Red
LNJ310M6URA	LNJ310M6URA	Green
LNJ410Q6YRA	LNJ410Q6YRA	Amber
LNJ810L6DRA	LNJ810L6DRA	Orange

### Absolute Maximum Ratings ( $T_a = 25^\circ\text{C}$ )

Lighting Color	$P_D$ (mW)	$I_F$ (mA)	$I_{FP}$ (mA)*	$V_R$ (V)	$T_{opr}$ ( $^\circ\text{C}$ )	$T_{stg}$ ( $^\circ\text{C}$ )
Red	60	20	60	4	-25 ~ +80	-30 ~ +85
Red	60	20	60	3	-25 ~ +80	-30 ~ +85
Green	60	20	60	4	-25 ~ +80	-30 ~ +85
Amber	60	20	60	4	-25 ~ +80	-30 ~ +85
Orange	60	20	60	3	-25 ~ +80	-30 ~ +85

\*Pulse width 1 msec. The condition of  $I_{FP}$  is duty 10%. Pulse width 1 msec

### Electro-Optical Characteristics ( $T_a = 25^\circ\text{C}$ )

Global Part No.	Lighting Color	Lens Color	$I_O$		$I_F$	$V_F$		$\lambda_p$	$\Delta\lambda$	$I_F$	$I_R$	
			Typ	Min		Typ	Max				Max	$V_R$
LNJ210C6RRA	Red	Clear	0.7	0.25	10	2.03	2.6	700	100	10	10	4
LNJ210C6ARA	Red	Clear	8.0	2.6	10	1.72	2.5	660	20	10	100	3
LNJ310M6URA	Green	Clear	8.0	3.0	10	2.03	2.6	565	30	10	10	4
LNJ410Q6YRA	Amber	Yellow Clear	2.5	0.8	10	2.0	2.6	590	30	10	10	4
LNJ810L6DRA	Orange	Red Clear	2.5	0.8	10	1.93	2.6	630	40	10	10	3
Unit	—	—	mcd	mcd	mA	V	V	nm	nm	mA	$\mu\text{A}$	V

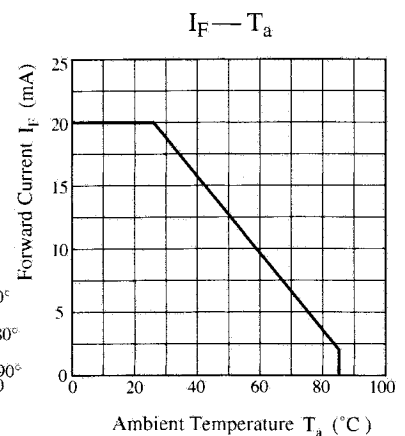
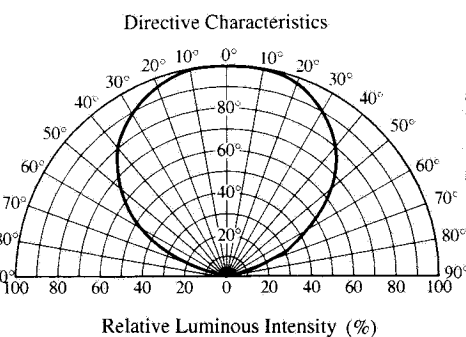
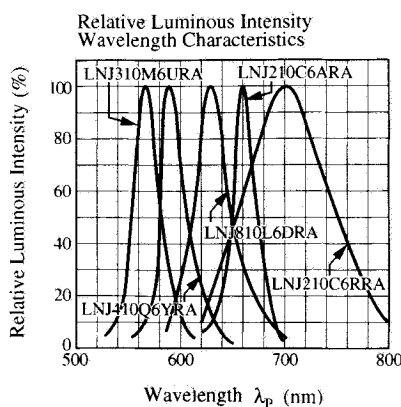
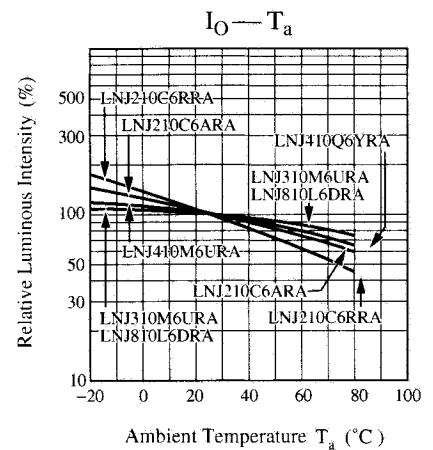
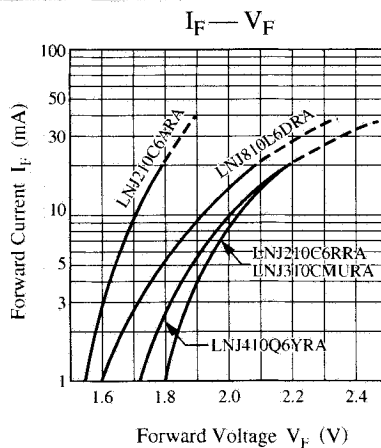
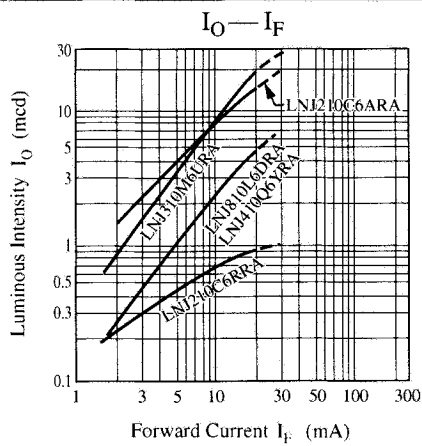
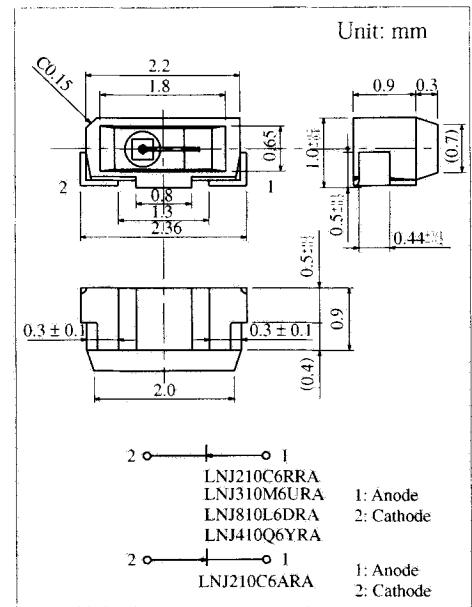

# Caution for Safety

 **DANGER**

## ■ This product contains Gallium Arsenide (GaAs).

GaAs powder and vapor are hazardous to human health if inhaled or ingested. Do not burn, destroy, cut, cleave off, or chemically dissolve the product. Follow related laws and ordinances for disposal. The product should be excluded from general industrial waste or household garbage.

### Request for your special attention and precautions in using the technical information and semiconductors described in this material

- (1) An export permit needs to be obtained from the competent authorities of the Japanese Government if any of the products or technical information described in this material and controlled under the "Foreign Exchange and Foreign Trade Law" is to be exported or taken out of Japan.
- (2) The technical information described in this material is limited to showing representative characteristics and applied circuits examples of the products. It neither warrants non-infringement of intellectual property right or any other rights owned by our company or a third party, nor grants any license.
- (3) We are not liable for the infringement of rights owned by a third party arising out of the use of the technical information as described in this material.
- (4) The products described in this material are intended to be used for standard applications or general electronic equipment (such as office equipment, communications equipment, measuring instruments and household appliances).  
Consult our sales staff in advance for information on the following applications:
  - Special applications (such as for airplanes, aerospace, automobiles, traffic control equipment, combustion equipment, life support systems and safety devices) in which exceptional quality and reliability are required, or if the failure or malfunction of the products may directly jeopardize life or harm the human body.
  - Any applications other than the standard applications intended.
- (5) The products and product specifications described in this material are subject to change without notice for modification and/or improvement. At the final stage of your design, purchasing, or use of the products, therefore, ask for the most up-to-date Product Standards in advance to make sure that the latest specifications satisfy your requirements.
- (6) When designing your equipment, comply with the guaranteed values, in particular those of maximum rating, the range of operating power supply voltage, and heat radiation characteristics. Otherwise, we will not be liable for any defect which may arise later in your equipment.  
Even when the products are used within the guaranteed values, take into the consideration of incidence of break down and failure mode, possible to occur to semiconductor products. Measures on the systems such as redundant design, arresting the spread of fire or preventing glitch are recommended in order to prevent physical injury, fire, social damages, for example, by using the products.
- (7) When using products for which damp-proof packing is required, observe the conditions (including shelf life and amount of time let standing of unsealed items) agreed upon when specification sheets are individually exchanged.
- (8) This material may be not reprinted or reproduced whether wholly or partially, without the prior written permission of Matsushita Electric Industrial Co., Ltd.