

Thyristor Module

$$V_{RRM} = 2 \times 800 \text{ V}$$

$$I_{TAV} = 27 \text{ A}$$

$$V_T = 1.27 \text{ V}$$

Phase leg

Part number

MCD26-08io8B

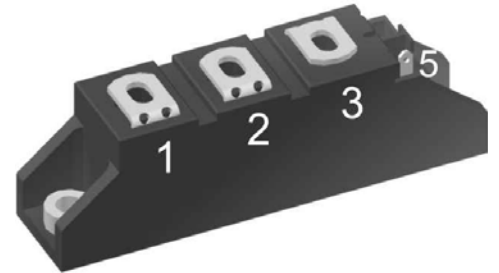

Backside: isolated

 E72873

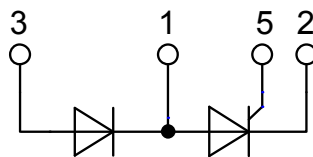

Features / Advantages:

- Thyristor for line frequency
- Planar passivated chip
- Long-term stability
- Direct Copper Bonded Al₂O₃-ceramic

Applications:

- Line rectifying 50/60 Hz
- Softstart AC motor control
- DC Motor control
- Power converter
- AC power control
- Lighting and temperature control

Package: TO-240AA

- Isolation Voltage: 3600V~
- Industry standard outline
- RoHS compliant
- Soldering pins for PCB mounting
- Base plate: DCB ceramic
- Reduced weight
- Advanced power cycling

Rectifier				Ratings			
Symbol	Definition	Conditions	min.	typ.	max.	Unit	
$V_{RSM/DSM}$	max. non-repetitive reverse/forward blocking voltage	$T_{VJ} = 25^{\circ}C$			900	V	
$V_{RRM/DRM}$	max. repetitive reverse/forward blocking voltage	$T_{VJ} = 25^{\circ}C$			800	V	
I_{RD}	reverse current, drain current	$V_{RD} = 800 V$	$T_{VJ} = 25^{\circ}C$		100	μA	
		$V_{RD} = 800 V$	$T_{VJ} = 125^{\circ}C$		3	mA	
V_T	forward voltage drop	$I_T = 40 A$	$T_{VJ} = 25^{\circ}C$		1.27	V	
					1.64	V	
		$I_T = 80 A$	$T_{VJ} = 125^{\circ}C$		1.27	V	
					1.65	V	
I_{TAV}	average forward current	$T_C = 85^{\circ}C$	$T_{VJ} = 125^{\circ}C$		27	A	
$I_{T(RMS)}$	RMS forward current	180° sine			50	A	
V_{T0}	threshold voltage	} for power loss calculation only	$T_{VJ} = 125^{\circ}C$		0.85	V	
r_T	slope resistance				11	m Ω	
R_{thJC}	thermal resistance junction to case				0.88	K/W	
R_{thCH}	thermal resistance case to heatsink			0.20		K/W	
P_{tot}	total power dissipation		$T_C = 25^{\circ}C$		115	W	
I_{TSM}	max. forward surge current	t = 10 ms; (50 Hz), sine	$T_{VJ} = 45^{\circ}C$	$V_R = 0 V$	520	A	
					t = 8,3 ms; (60 Hz), sine	560	A
		t = 10 ms; (50 Hz), sine	$T_{VJ} = 125^{\circ}C$	$V_R = 0 V$	440	A	
					t = 8,3 ms; (60 Hz), sine	475	A
I^2t	value for fusing	t = 10 ms; (50 Hz), sine	$T_{VJ} = 45^{\circ}C$	$V_R = 0 V$	1.35	kA ² s	
					t = 8,3 ms; (60 Hz), sine	1.31	kA ² s
		t = 10 ms; (50 Hz), sine	$T_{VJ} = 125^{\circ}C$	$V_R = 0 V$	970	A ² s	
					t = 8,3 ms; (60 Hz), sine	940	A ² s
C_J	junction capacitance	$V_R = 400 V$ f = 1 MHz	$T_{VJ} = 25^{\circ}C$		22	pF	
P_{GM}	max. gate power dissipation	$t_p = 30 \mu s$	$T_C = 125^{\circ}C$		10	W	
		$t_p = 300 \mu s$			5	W	
P_{GAV}	average gate power dissipation				0.5	W	
$(di/dt)_{cr}$	critical rate of rise of current	$T_{VJ} = 125^{\circ}C$; f = 50 Hz	repetitive, $I_T = 45 A$		150	A/ μs	
				$t_p = 200 \mu s$; $di_G/dt = 0.45 A/\mu s$;			
$(dv/dt)_{cr}$	critical rate of rise of voltage	$V_D = \frac{2}{3} V_{DRM}$	$T_{VJ} = 125^{\circ}C$	$I_G = 0.45 A$; $V_D = \frac{2}{3} V_{DRM}$	non-repet., $I_T = 27 A$	500	A/ μs
						$R_{GK} = \infty$; method 1 (linear voltage rise)	
V_{GT}	gate trigger voltage	$V_D = 6 V$	$T_{VJ} = 25^{\circ}C$		1.5	V	
			$T_{VJ} = -40^{\circ}C$		1.6	V	
I_{GT}	gate trigger current	$V_D = 6 V$	$T_{VJ} = 25^{\circ}C$		100	mA	
			$T_{VJ} = -40^{\circ}C$		200	mA	
V_{GD}	gate non-trigger voltage	$V_D = \frac{2}{3} V_{DRM}$	$T_{VJ} = 125^{\circ}C$		0.2	V	
I_{GD}	gate non-trigger current				10	mA	
I_L	latching current	$t_p = 10 \mu s$	$T_{VJ} = 25^{\circ}C$	$I_G = 0.45 A$; $di_G/dt = 0.45 A/\mu s$	450	mA	
I_H	holding current	$V_D = 6 V$ $R_{GK} = \infty$	$T_{VJ} = 25^{\circ}C$		200	mA	
t_{gd}	gate controlled delay time	$V_D = \frac{1}{2} V_{DRM}$	$T_{VJ} = 25^{\circ}C$	$I_G = 0.45 A$; $di_G/dt = 0.45 A/\mu s$	2	μs	
t_q	turn-off time	$V_R = 100 V$; $I_T = 20 A$; $V_D = \frac{2}{3} V_{DRM}$	$T_{VJ} = 125^{\circ}C$		150	μs	
		$di/dt = 10 A/\mu s$; $dv/dt = 20 V/\mu s$; $t_p = 200 \mu s$					

Package TO-240AA				Ratings		
Symbol	Definition	Conditions	min.	typ.	max.	Unit
I_{RMS}	RMS current	per terminal			200	A
T_{stg}	storage temperature		-40		125	°C
T_{VJ}	virtual junction temperature		-40		125	°C
Weight				90		g
M_D	mounting torque		2.5		4	Nm
M_T	terminal torque		2.5		4	Nm
$d_{Spp/App}$	creepage distance on surface striking distance through air	terminal to terminal	13.0	9.7		mm
$d_{Spb/Apb}$		terminal to backside	16.0	16.0		mm
V_{ISOL}	isolation voltage	t = 1 second		3600		V
		t = 1 minute	50/60 Hz, RMS; $I_{ISOL} \leq 1$ mA	3000		V

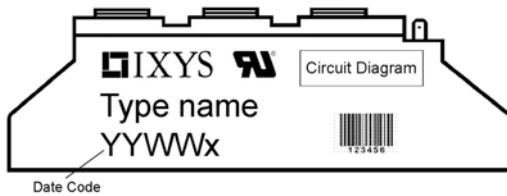

Ordering	Part Number	Marking on Product	Delivery Mode	Quantity	Code No.
Standard	MCD26-08io8B	MCD26-08io8B	Box	6	453242

Similar Part	Package	Voltage class
MCMA35PD1200TB	TO-240AA-1B	1200
MCMA50PD1200TB	TO-240AA-1B	1200

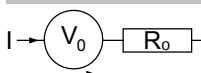
Equivalent Circuits for Simulation
** on die level*
 $T_{VJ} = 125\text{ °C}$

Thyristor

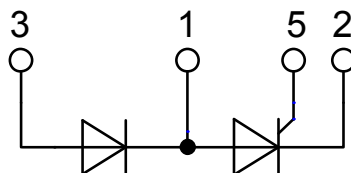
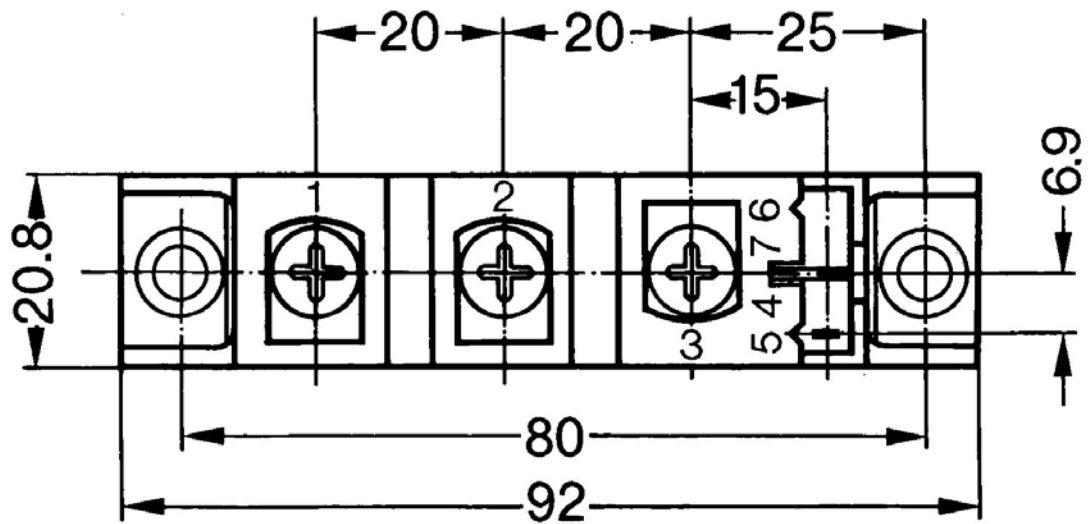
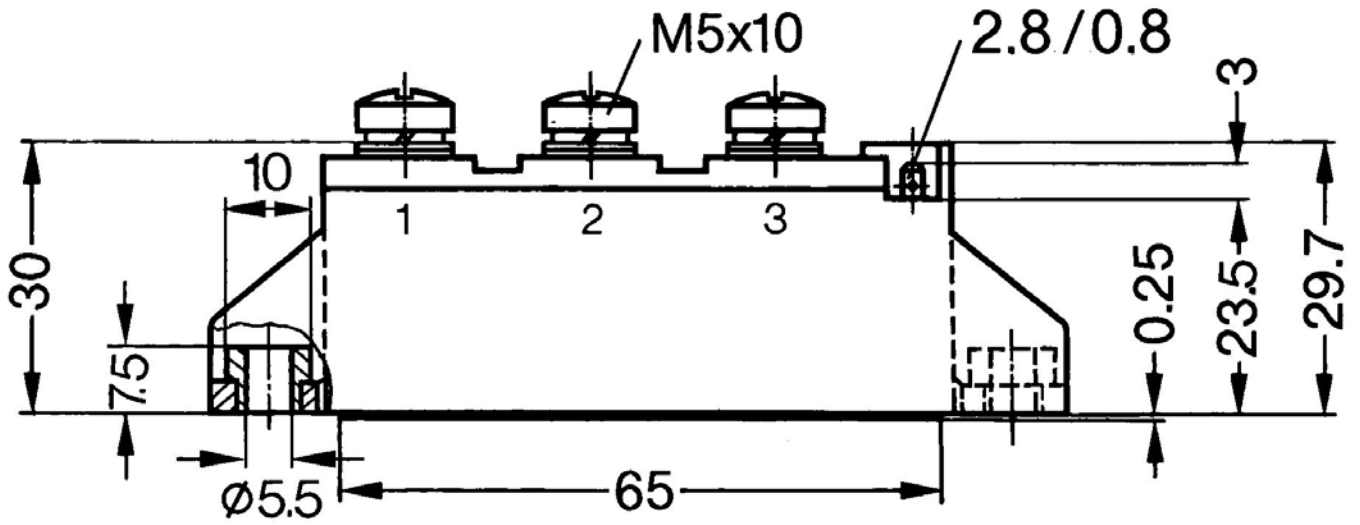
$V_{0\ max}$	threshold voltage	0.85	V
$R_{0\ max}$	slope resistance *	9.8	mΩ



Thyristor

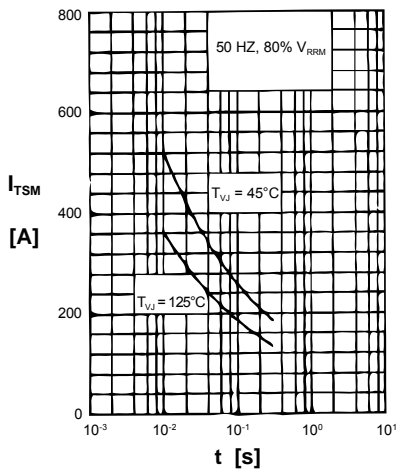

Fig. 1 Surge overload current
 I_{TSM} : Crest value, t : duration

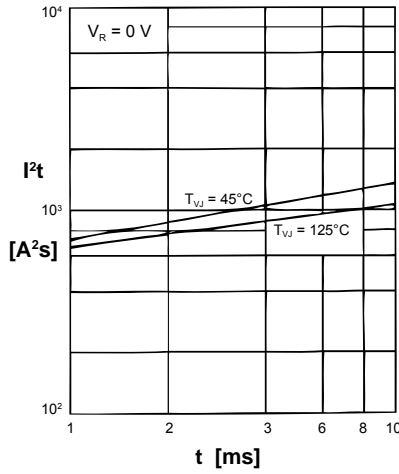

Fig. 2 I^2t versus time (1-10 ms)

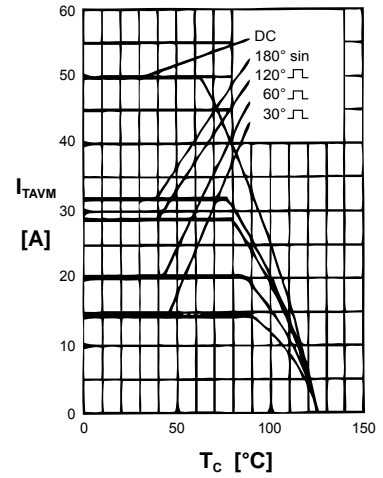

Fig. 3 Max. forward current at case temperature

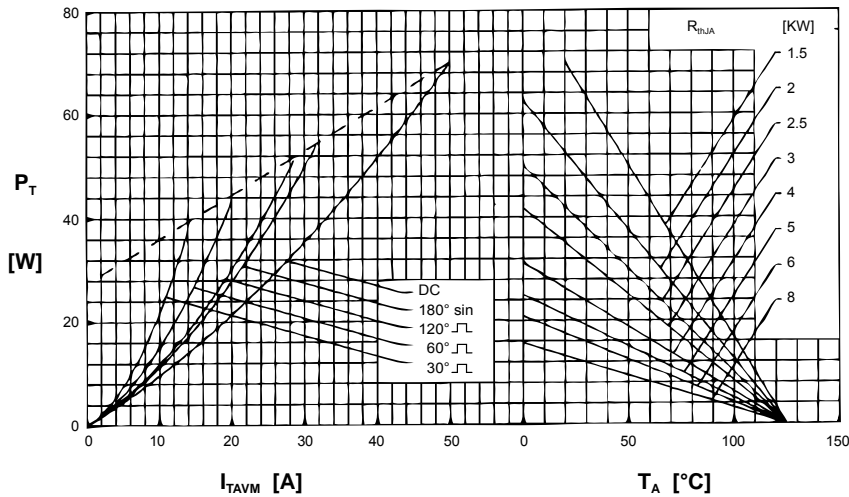

Fig. 4 Power dissipation versus onstate current & ambient temp. (per thyristor)

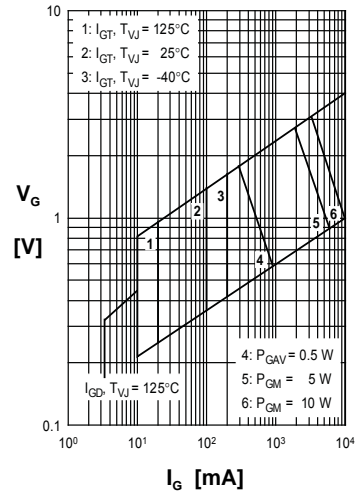

Fig. 5 Gate trigger charact.

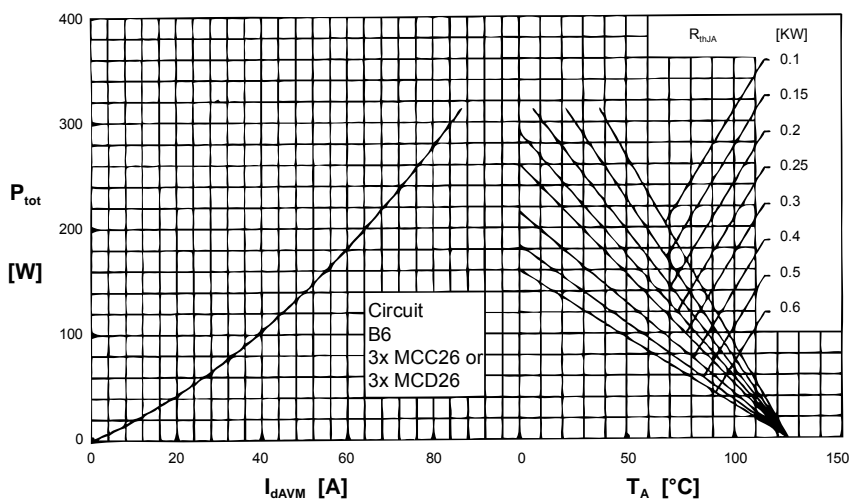

Fig. 6 Three phase rectifier bridge: Power dissipation versus direct output current and ambient temperature

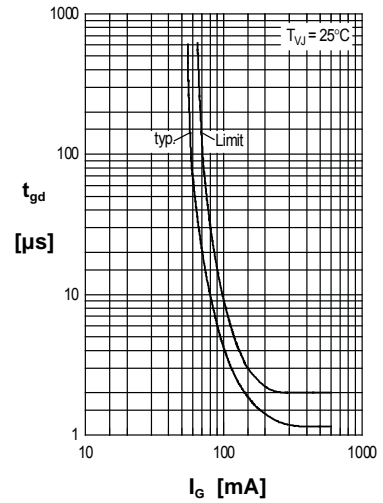

Fig. 7 Gate trigger delay time

Rectifier

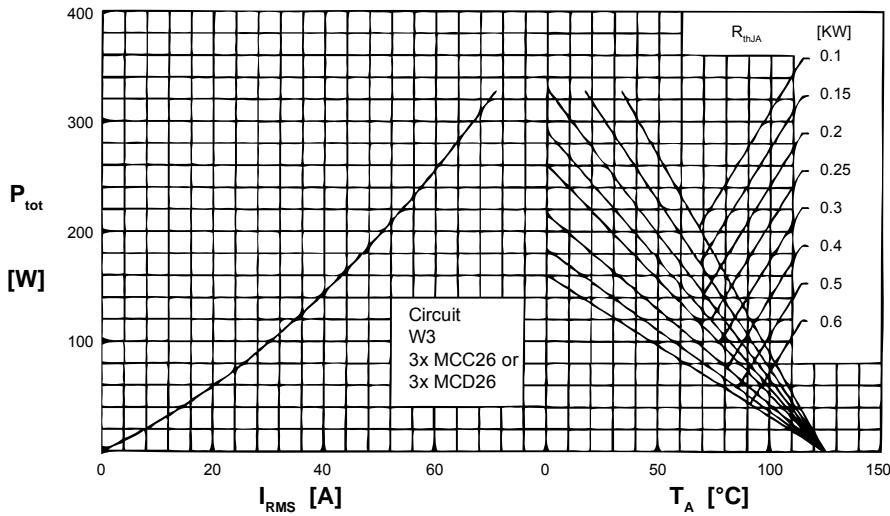

Fig. 8 Three phase AC-controller: Power dissipation vs. RMS output current and ambient temperature

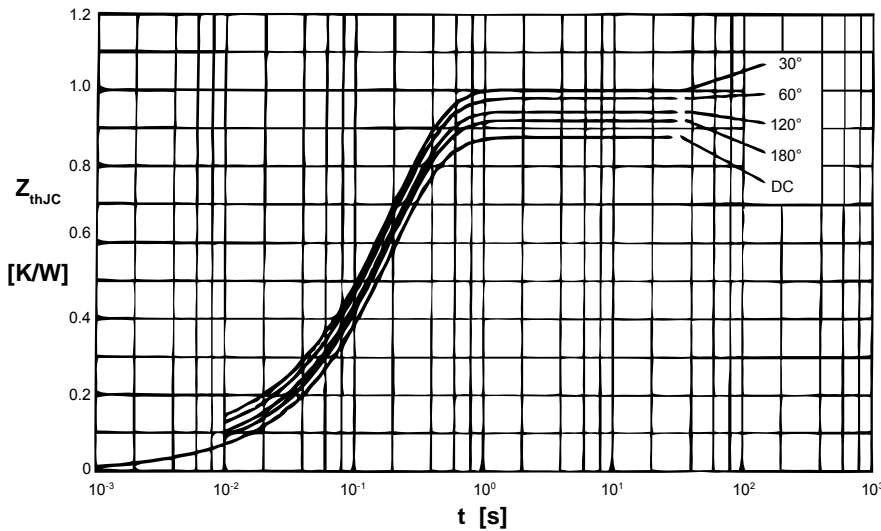

Fig. 9 Transient thermal impedance junction to case (per thyristor)

R_{thJC} for various conduction angles d :

d	R_{thJC} [K/W]
DC	0.88
180°	0.92
120°	0.95
60°	0.98
30°	1.01

Constants for Z_{thJC} calculation:

i	R_{thi} [K/W]	t_i [s]
1	0.019	0.0031
2	0.029	0.0216
3	0.832	0.1910

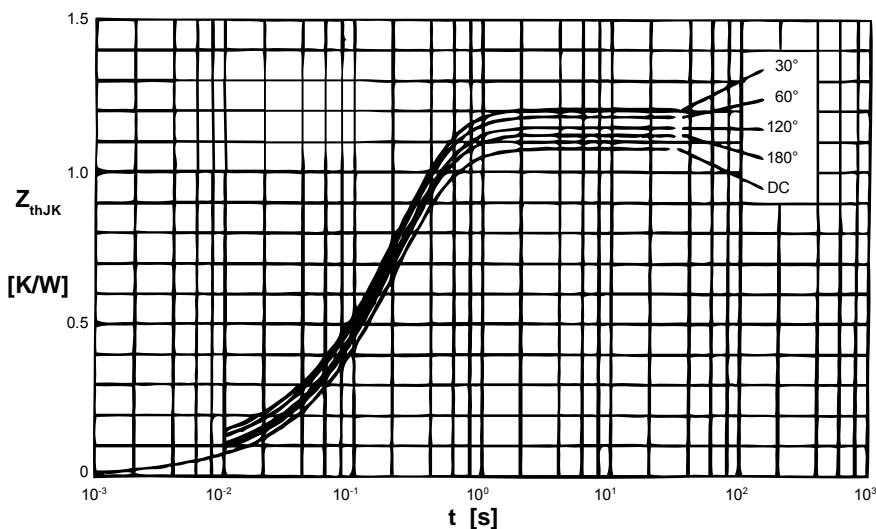

Fig. 10 Transient thermal impedance junction to heatsink (per thyristor)

R_{thJK} for various conduction angles d :

d	R_{thJK} [K/W]
DC	1.08
180°	1.12
120°	1.15
60°	1.18
30°	1.21

Constants for Z_{thJK} calculation:

i	R_{thi} [K/W]	t_i [s]
1	0.019	0.0031
2	0.029	0.0216
3	0.832	0.1910
4	0.200	0.4500