

Thyristor Module

$$V_{RRM} = 2 \times 1200 \text{ V}$$

$$I_{TAV} = 49 \text{ A}$$

$$V_T = 1.34 \text{ V}$$

Phase leg

Part number

MCD44-12io8B

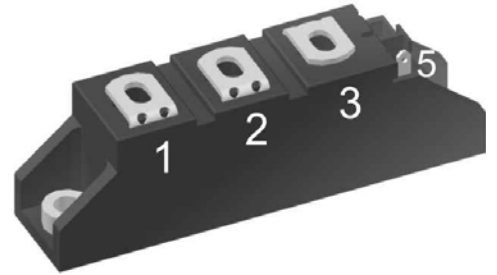

Backside: isolated

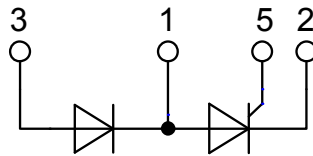
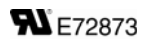

Features / Advantages:

- Thyristor for line frequency
- Planar passivated chip
- Long-term stability
- Direct Copper Bonded Al₂O₃-ceramic

Applications:

- Line rectifying 50/60 Hz
- Softstart AC motor control
- DC Motor control
- Power converter
- AC power control
- Lighting and temperature control

Package: TO-240AA

- Isolation Voltage: 3600V~
- Industry standard outline
- RoHS compliant
- Soldering pins for PCB mounting
- Base plate: DCB ceramic
- Reduced weight
- Advanced power cycling

Rectifier				Ratings			
Symbol	Definition	Conditions	min.	typ.	max.	Unit	
$V_{RSM/DSM}$	max. non-repetitive reverse/forward blocking voltage	$T_{VJ} = 25^{\circ}C$			1300	V	
$V_{RRM/DRM}$	max. repetitive reverse/forward blocking voltage	$T_{VJ} = 25^{\circ}C$			1200	V	
I_{RD}	reverse current, drain current	$V_{RD} = 1200 V$	$T_{VJ} = 25^{\circ}C$		100	μA	
		$V_{RD} = 1200 V$	$T_{VJ} = 125^{\circ}C$		5	mA	
V_T	forward voltage drop	$I_T = 100 A$	$T_{VJ} = 25^{\circ}C$		1.34	V	
		$I_T = 200 A$			1.75	V	
		$I_T = 100 A$	$T_{VJ} = 125^{\circ}C$		1.34	V	
		$I_T = 200 A$			1.80	V	
I_{TAV}	average forward current	$T_C = 85^{\circ}C$	$T_{VJ} = 125^{\circ}C$		49	A	
$I_{T(RMS)}$	RMS forward current	180° sine			77	A	
V_{T0}	threshold voltage	} for power loss calculation only	$T_{VJ} = 125^{\circ}C$		0.85	V	
r_T	slope resistance				5.3	m Ω	
R_{thJC}	thermal resistance junction to case				0.53	K/W	
R_{thCH}	thermal resistance case to heatsink			0.20		K/W	
P_{tot}	total power dissipation		$T_C = 25^{\circ}C$		180	W	
I_{TSM}	max. forward surge current	$t = 10 \text{ ms}; (50 \text{ Hz}), \text{ sine}$	$T_{VJ} = 45^{\circ}C$		1.15	kA	
		$t = 8,3 \text{ ms}; (60 \text{ Hz}), \text{ sine}$	$V_R = 0 V$		1.24	kA	
		$t = 10 \text{ ms}; (50 \text{ Hz}), \text{ sine}$	$T_{VJ} = 125^{\circ}C$		980	A	
		$t = 8,3 \text{ ms}; (60 \text{ Hz}), \text{ sine}$	$V_R = 0 V$		1.06	kA	
I^2t	value for fusing	$t = 10 \text{ ms}; (50 \text{ Hz}), \text{ sine}$	$T_{VJ} = 45^{\circ}C$		6.62	kA ² s	
		$t = 8,3 \text{ ms}; (60 \text{ Hz}), \text{ sine}$	$V_R = 0 V$		6.40	kA ² s	
		$t = 10 \text{ ms}; (50 \text{ Hz}), \text{ sine}$	$T_{VJ} = 125^{\circ}C$		4.80	kA ² s	
		$t = 8,3 \text{ ms}; (60 \text{ Hz}), \text{ sine}$	$V_R = 0 V$		4.63	kA ² s	
C_J	junction capacitance	$V_R = 400 V \quad f = 1 \text{ MHz}$	$T_{VJ} = 25^{\circ}C$		54	pF	
P_{GM}	max. gate power dissipation	$t_p = 30 \mu s$	$T_C = 125^{\circ}C$		10	W	
		$t_p = 300 \mu s$			5	W	
P_{GAV}	average gate power dissipation				0.5	W	
$(di/dt)_{cr}$	critical rate of rise of current	$T_{VJ} = 125^{\circ}C; f = 50 \text{ Hz}$	repetitive, $I_T = 150 A$		150	A/ μs	
		$t_p = 200 \mu s; di_G/dt = 0.45 A/\mu s;$ $I_G = 0.45 A; V_D = \frac{2}{3} V_{DRM}$	non-repet., $I_T = 49 A$		500	A/ μs	
$(dv/dt)_{cr}$	critical rate of rise of voltage	$V_D = \frac{2}{3} V_{DRM}$ $R_{GK} = \infty; \text{ method 1 (linear voltage rise)}$	$T_{VJ} = 125^{\circ}C$		1000	V/ μs	
V_{GT}	gate trigger voltage	$V_D = 6 V$	$T_{VJ} = 25^{\circ}C$		1.5	V	
			$T_{VJ} = -40^{\circ}C$		1.6	V	
I_{GT}	gate trigger current	$V_D = 6 V$	$T_{VJ} = 25^{\circ}C$		100	mA	
			$T_{VJ} = -40^{\circ}C$		200	mA	
V_{GD}	gate non-trigger voltage	$V_D = \frac{2}{3} V_{DRM}$	$T_{VJ} = 125^{\circ}C$		0.2	V	
I_{GD}	gate non-trigger current				10	mA	
I_L	latching current	$t_p = 10 \mu s$	$T_{VJ} = 25^{\circ}C$		450	mA	
		$I_G = 0.45 A; di_G/dt = 0.45 A/\mu s$					
I_H	holding current	$V_D = 6 V \quad R_{GK} = \infty$	$T_{VJ} = 25^{\circ}C$		200	mA	
t_{gd}	gate controlled delay time	$V_D = \frac{1}{2} V_{DRM}$	$T_{VJ} = 25^{\circ}C$		2	μs	
		$I_G = 0.45 A; di_G/dt = 0.45 A/\mu s$					
t_q	turn-off time	$V_R = 100 V; I_T = 120 A; V_D = \frac{2}{3} V_{DRM}$ $di/dt = 10 A/\mu s; dv/dt = 20 V/\mu s; t_p = 200 \mu s$	$T_{VJ} = 125^{\circ}C$		150	μs	

Package TO-240AA				Ratings		
Symbol	Definition	Conditions	min.	typ.	max.	Unit
I_{RMS}	RMS current	per terminal			200	A
T_{stg}	storage temperature		-40		125	°C
T_{VJ}	virtual junction temperature		-40		125	°C
Weight				90		g
M_D	mounting torque		2.5		4	Nm
M_T	terminal torque		2.5		4	Nm
$d_{Spp/App}$	creepage distance on surface striking distance through air	terminal to terminal	13.0	9.7		mm
$d_{Spb/Apb}$		terminal to backside	16.0	16.0		mm
V_{ISOL}	isolation voltage	t = 1 second		3600		V
		t = 1 minute	50/60 Hz, RMS; $I_{ISOL} \leq 1$ mA	3000		V

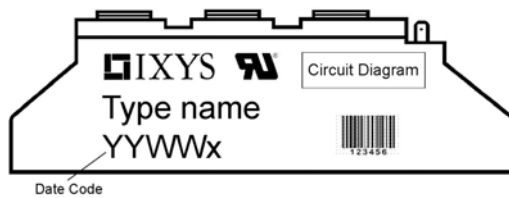

Ordering	Part Number	Marking on Product	Delivery Mode	Quantity	Code No.
Standard	MCD44-12io8B	MCD44-12io8B	Box	3	457639

Similar Part	Package	Voltage class
MCMA50PD1200TB	TO-240AA-1B	1200
MCMA65PD1200TB	TO-240AA-1B	1200

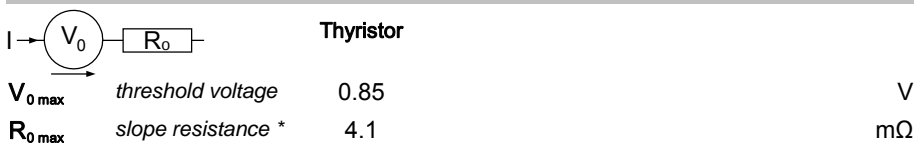
Equivalent Circuits for Simulation * on die level $T_{VJ} = 125^\circ\text{C}$

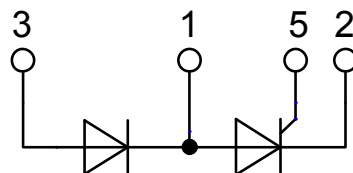
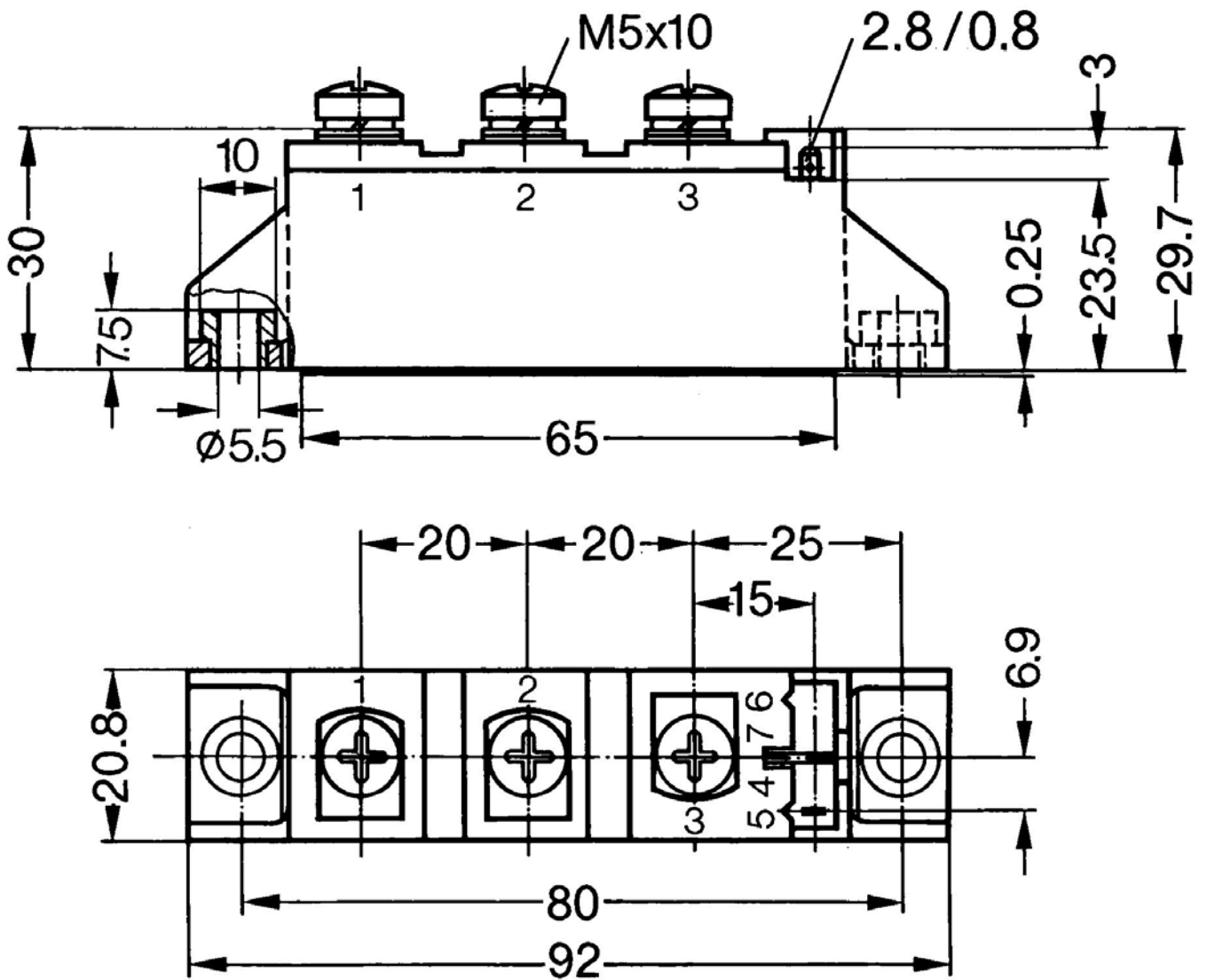

Thyristor

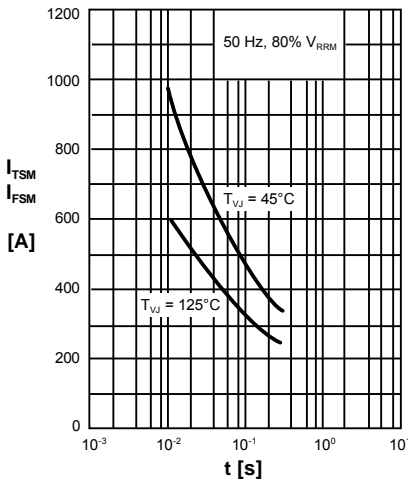

Fig. 1 Surge overload current
 I_{TSM} , I_{FSM} : Crest value, t : duration

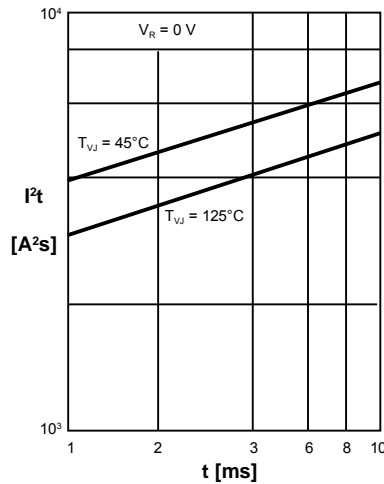

Fig. 2 I^2t versus time (1-10 ms)

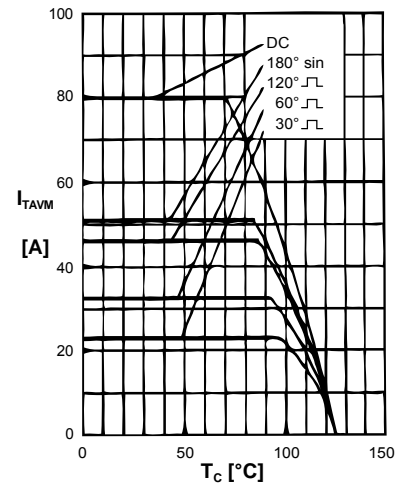

Fig. 3 Maximum forward current at case temperature

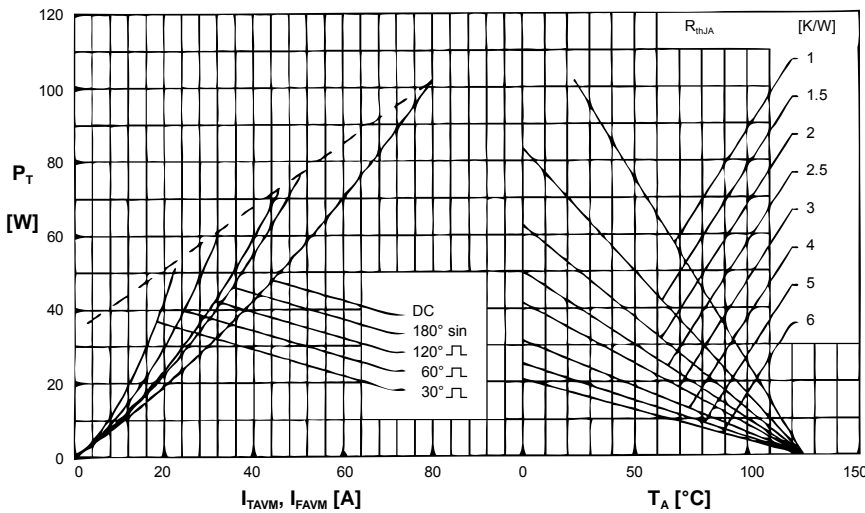

Fig. 4 Power dissipation vs. onstate current and ambient temperature (per thyristor/diode)

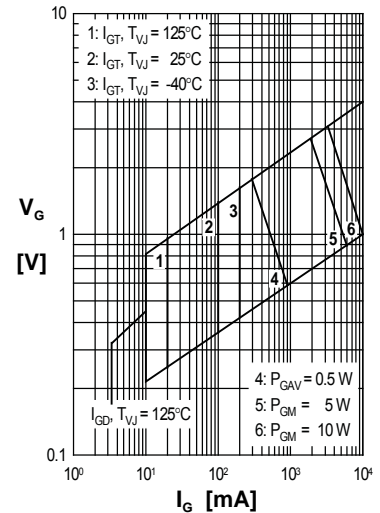

Fig. 5 Gate trigger characteristics

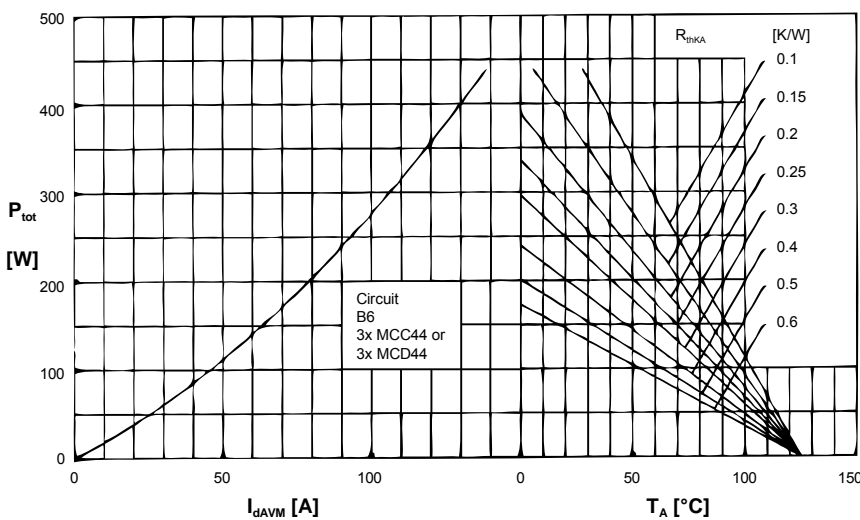

Fig. 6 Three phase rectifier bridge: Power dissipation versus direct output current and ambient temperature

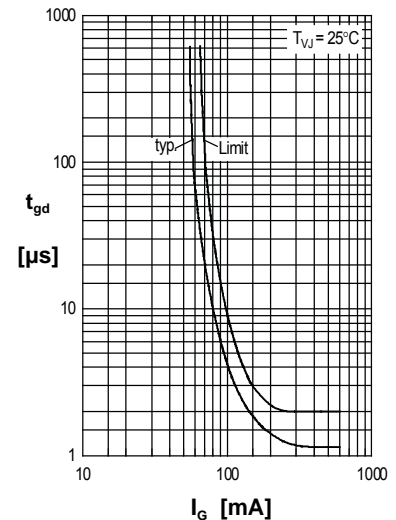

Fig. 7 Gate trigger delay time

Rectifier

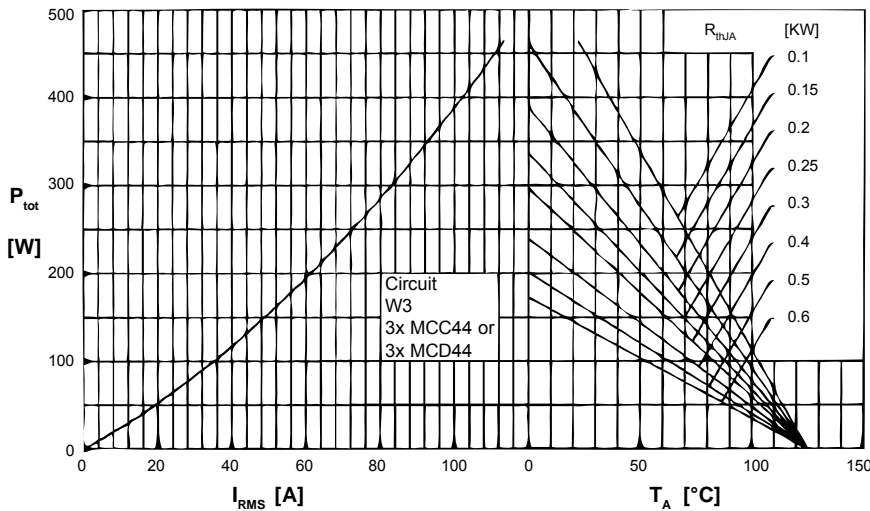

Fig. 8 Three phase AC-controller: Power dissipation versus RMS output current and ambient temperature

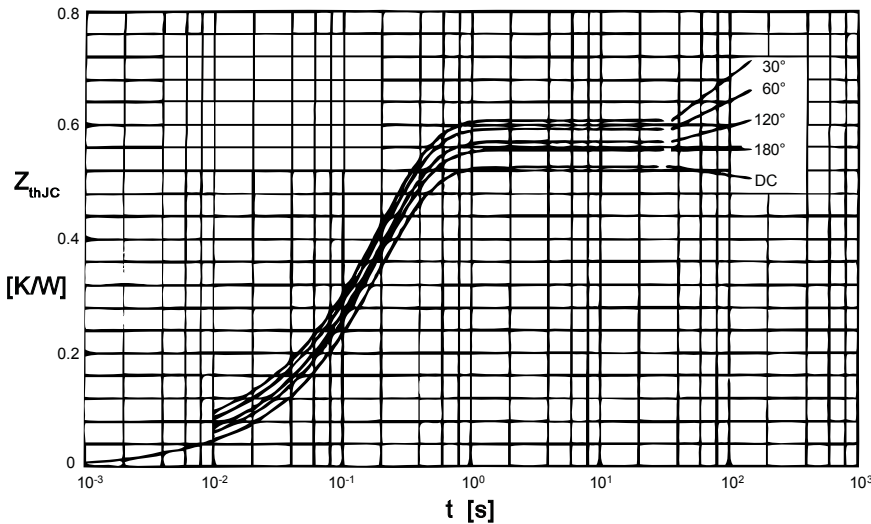

Fig. 9 Transient thermal impedance junction to case (per thyristor)

R_{thJC} for various conduction angles d:

d	R_{thJC} [KW]
DC	0.53
180°	0.55
120°	0.58
60°	0.60
30°	0.62

Constants for Z_{thJC} calculation:

i	R_{thi} [KW]	t_i [s]
1	0.015	0.0035
2	0.026	0.0200
3	0.489	0.1950

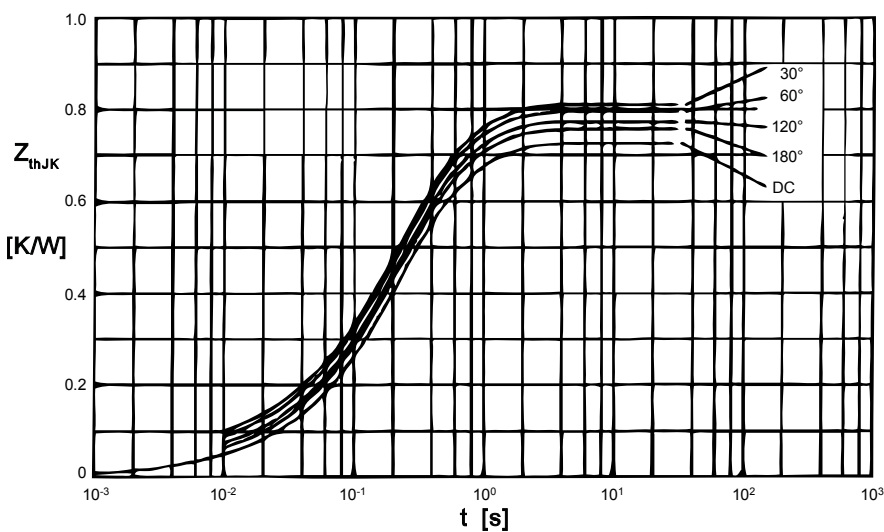

Fig. 10 Transient thermal impedance junction to heatsink (per thyristor)

R_{thJK} for various conduction angles d:

d	R_{thJK} [KW]
DC	0.73
180°	0.75
120°	0.78
60°	0.80
30°	0.82

Constants for Z_{thJK} calculation:

i	R_{thi} [KW]	t_i [s]
1	0.015	0.0035
2	0.026	0.0200
3	0.489	0.0195
4	0.200	0.6800