Si114x MULTI-FUNCTION KIT USER'S GUIDE

1. Kit Contents

The Si114x Multi-Function Kit contains the following items:

- Si114x Multi-Function Board
- Si114x-MFB Quick Start Guide
- 2 USB Cables

2. Introduction

The Si114x-MFB is intended as an evaluation and development platform for the Si1141, Si1142, and Si1143 infrared proximity and ambient light sensors. The board has two sides which are separate systems that only share communications and debug connections to the PC. The active side is chosen using the hardware switch S1, shown in Figure 1. When the switch is in the upward position, the Top-Side is the active side while the Bottom-Side is active when S1 is in the downward position. As shown on the left side of Figure 1, the main components of the top side of the Si114x multi-function board (Si114x-MFB) are the Si1143 sensor (U4), the C8051F931 microcontroller (U1), and the infrared emitters (DS2 through DS4). On this PCB, the infrared emitters used are OSRAM part number SFH 4056. These emitters have a power rating of 40 mW and a half-angle of 22 degrees. As shown on the right side of Figure 1, the main components of the bottom side of the Si114x-MFB are the Si1143 sensor (U6), the C8051F931 microcontroller (U5), and the infrared emitter DS5. This emitter is OSRAM part number SFH 4650 and has a power rating of 45 mW and a half-angle of 15 degrees. Other emitters with different characteristics may also be used, depending on the specific application requirements.

The default firmware for the top-side of the board is a thumb-scroll implementation that measures the infrared light energy detected by the Si1143 while each of three infrared emitters are independently activated. The infrared light from these emitters will be reflected back to the Si1143 by a thumb that is swiped in proximity to the sensor. The firmware is able to detect different gestures using the infrared sensor, as described in Table 1 on page 6. The nine LEDs DS8-DS16 will change state to indicate what gesture was recognized. The Si1143's ambient light sensor (ALS) is also monitored by the firmware. The default firmware is intended to be used in conjunction with the Si114x Performance Analysis Tool to provide user feedback.

The default firmware on the bottom-side of the board is a long-range implementation that measures the infrared light energy detected by the Si1143 while a single infrared emitter is activated. All three of the Si1143's LED drivers are connected to the one emitter to allow multiple drivers to activate the emitter at the same time in order to send more current through the emitter than one driver can provide. Driving more current through the emitters can help achieve longer ranges of detection because the infrared LEDs emit more light with more current. The default firmware only uses one driver at the default pulse width to drive the LED. The five LEDs DS17-DS21 will change state to indicate how much infrared light feedback is being measured. The Si1143's ambient light sensor (ALS) is also monitored by the firmware. The default firmware is intended to be used in conjunction with the Si114x Performance Analysis Tool to provide user feedback.

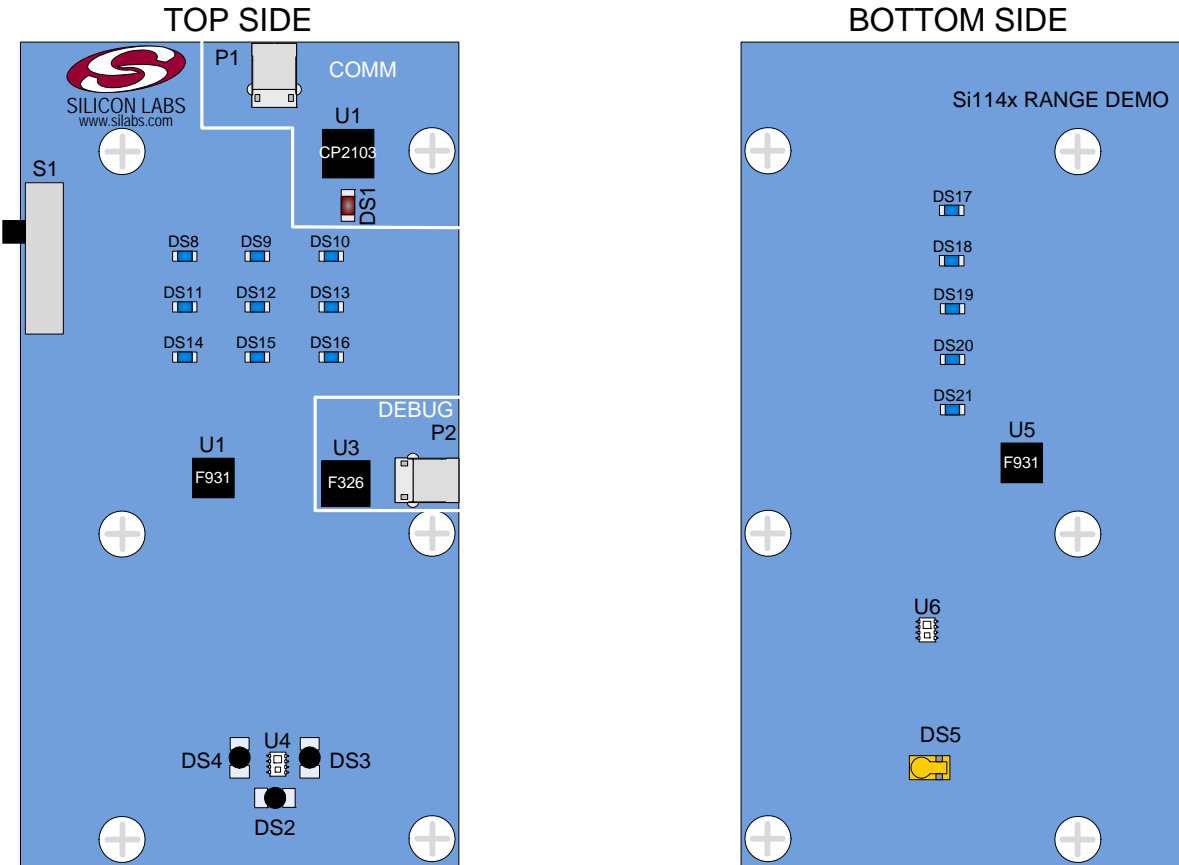

Figure 1. Si1143 Evaluation Board

3. Software Overview

There are several optional software packages available to support the Si114x Multi-Function Kit. The Si114x Performance Analysis Tool can be used for initial evaluation to collect data from the board over the USB interface and display it graphically. For users ready to develop their own software, the Si114x Programmer's Toolkit API enables rapid development of Si114x software in a PC environment using the Si114x Multi-Function Kit. The Si114x Programmer's Toolkit contains example source code that allows developers to get started quickly and then tailor their code to their needs. In addition, the Silicon Labs Integrated Development Environment (IDE) provides a means of developing code for the C8051F931 and uses the USB DEBUG connection on the board to program the MCU and perform in-system debugging. All of the supporting software can be downloaded from the web at the URL <http://www.silabs.com/products/sensors/pages/optical-sensor-software.aspx>.

3.1. Using the Si114x-MFB with the Performance Analysis Tool

The Si114x Multi-Function Board is supported by the Si114x Performance Analysis Tool. The Performance Analysis Tool allows users to see real-time infrared proximity and ambient light measurements from the Si1143 in a graphical form. The communications interface to the Si114x Multi-Function Board is provided over the USB connection.

To use the Performance Analysis Tool with the Si114x Multi-Function Board:

1. Connect the Si114x Multi-Function Board to the PC using a cable plugged into the COMM USB port.
2. Launch the Performance Analysis Tool from the "Start" menu.
3. Select the board from the "Devices" menu (typically either COM3 or COM4 depending on your system).
4. Select the channels you wish to display on the picture of the slider board that appears. The individual channels available are described in "3.1.1. Channel Selection".
5. Click the green "Acquisition" arrow to begin collecting data

Figure 2 shows an example of the Performance Analysis Tool output when connected to the Si114x Multi-Function Board. To generate the graph, a thumb was moved above the thumb-scroll side of the board. The selected traces shown are the raw data measurements for the amount of Infrared light being reflected onto the part. The pink trace represents the proximity measurements from infrared emitter DS3; the green trace represents the measurements from infrared emitter DS4, and the yellow trace represents the measurements from infrared emitter DS2.

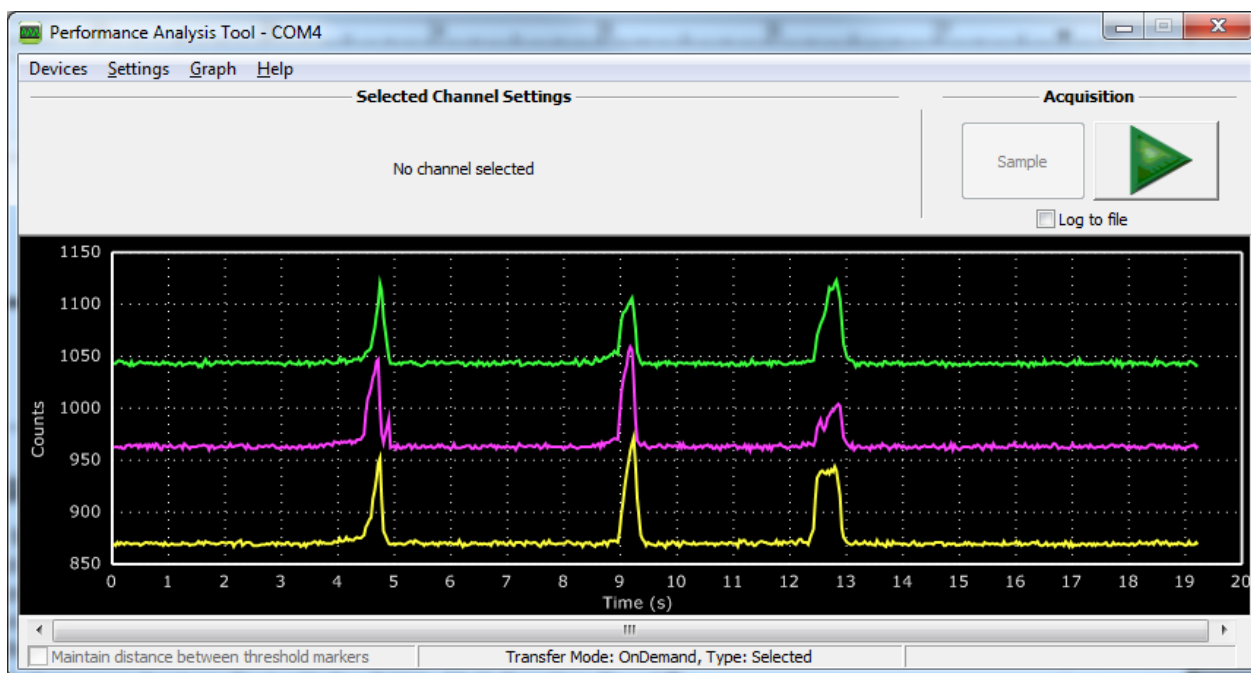

Figure 2. Performance Analysis Tool Main Window

Si114x-MFB

3.1.1. Channel Selection

Selecting which channels to display is done by checking the appropriate boxes on the Board Representation window, shown in Figure 3, and the Generic Data window, shown in Figure 4. There are two different groups of measurements available from the example firmware: raw data channels and generic data channels.

3.1.1.1. Raw Data Channels

The raw data measurements can be seen by selecting the channels from the Board Representation window, shown in Figure 3. The two types of raw data measurements are ambient light and infrared proximity.

1. Raw ambient light measurements. The ambient light channels are Channel 0 (red) and Channel 1 (blue). Channel 0 displays measurements of the ambient visible light while Channel 1 displays measurements of the ambient infrared light.
2. Raw infrared proximity measurements. The infrared proximity channels are Channel 2 (pink) readings using DS3, Channel 3 (green) readings using DS4, and Channel 4 (yellow) readings using DS2. Channels 3 and 4 will not be available for the Bottom-Side since it is a single LED implementation. The output is proportional to the amount of infrared light being reflected onto the part by an object above the board. These outputs are 16-bit unsigned values.

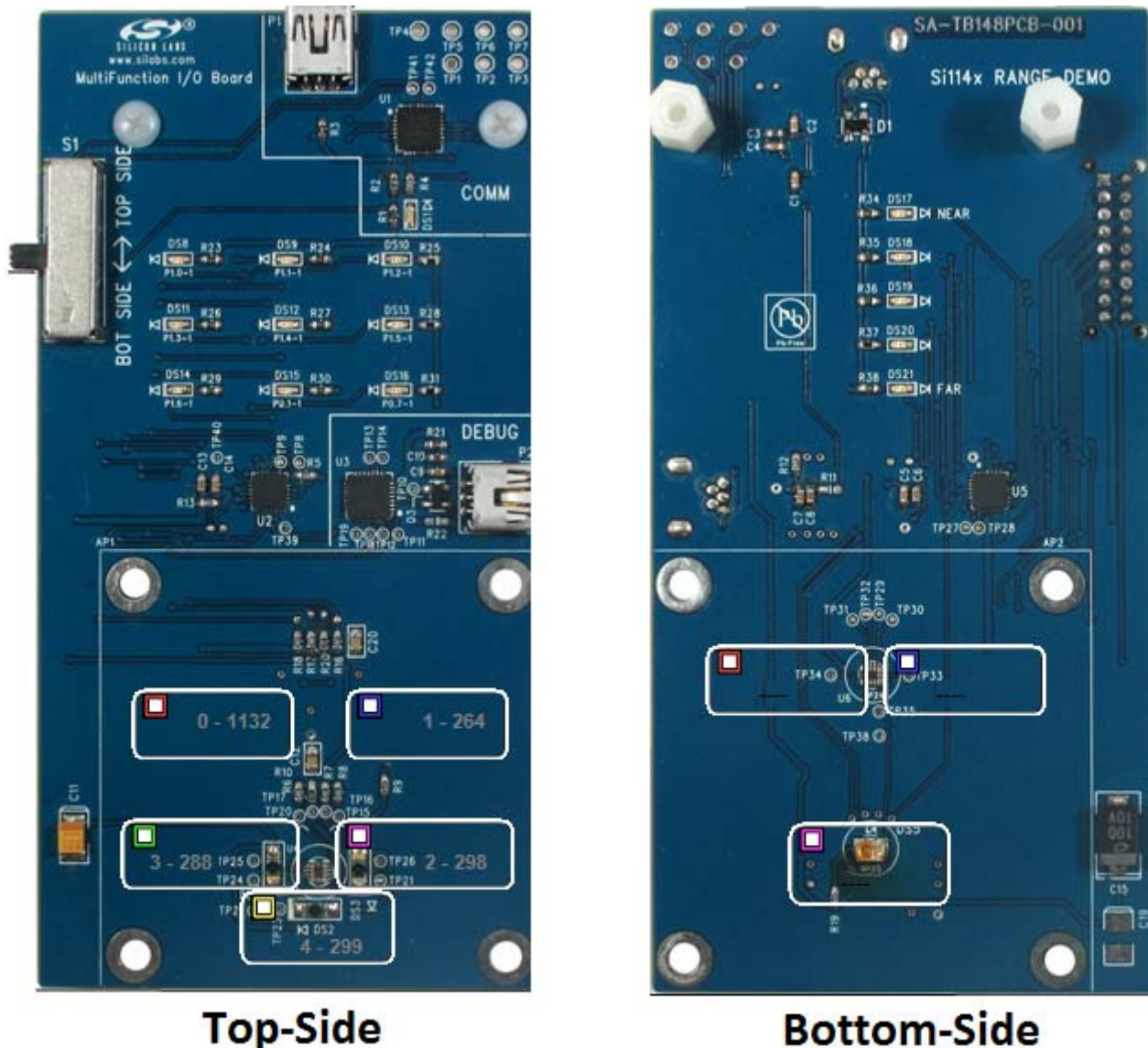

Figure 3. Raw Data Channel Selection

3.1.1.2. Generic Data Channels

The generic data channels contain any data generated by the host MCU. These 16-bit channels can be anything from simple debug channels to calculated position values. See Table 2 or Table 3 for an explanation of all the channels shown in Figure 4.



Figure 4. Generic Data Channel Selection

3.1.2. Gesture Sensing

In addition to infrared and ambient light measurements, the example firmware for the top side contains algorithms for gesture recognition. When connected to the board with the Performance Analysis Tool, a group window will appear, as shown in Figure 5. When a gesture is recognized by firmware, the gesture name and parameter information will be added to the top of the 3D Gesture group. Five gestures are supported by the example code. The parameters for each gesture are listed in Table 1.

To use the thumb-scroll gestures with high accuracy, the user must be sure to swipe the thumb by starting outside of the orange box on the overlay and swiping across the box and exiting the orange box on the opposite side. The thumb should be laid flat such that the thumb creates the most surface area on the glass. For a Tap gesture, the thumb should enter and exit as straight as possible along the axis which is normal to the surface of the overlay. If a Tap is attempted and the thumb exits at an off-angle, the Tap might be identified as a swipe.

The speed of the swipe can be determined by the Duration value in the Group Window below. The user should be weary that very fast swipes have a higher chance of being recognized incorrectly, and very slow swipes might not be recognized as a gesture because the firmware caps the duration at 255 counts. Each count represents 1.6 ms.

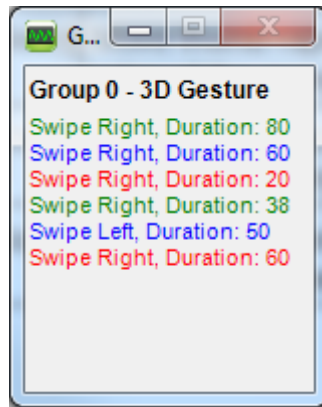

Figure 5. Performance Analysis Tool Group Window

Table 1. Recognized Gestures

Gesture Name	Parameter	Parameter Range	Description of Action
Swipe Left	Duration	1 255 (Fast to Slow)	Move thumb from the right edge to the left edge of the orange square on the overlay.
Swipe Right	Duration	1 255 (Fast to Slow)	Move thumb from the left edge to the right edge of the orange square on the overlay.
Swipe Up	Duration	1 255 (Fast to Slow)	Move thumb from the bottom edge to the top edge of the orange square on the overlay.
Swipe Down	Duration	1 255 (Fast to Slow)	Move thumb from the top edge to the bottom edge of the orange square on the overlay.
Tap	Duration	1 255 (Fast to Slow)	Move thumb from high above the overlay onto the center of the orange square and retract.

3.2. Si114x Programmer's Toolkit

3.2.1. Software API

The Si114x Programmer's Toolkit API enables rapid development of Si114x software in a PC environment using the Si114x Multi-Function Kit. By emulating an I²C interface over USB, the Si114x Programmer's Toolkit API allows source code to be developed on a PC and then migrated quickly and easily to an MCU environment once target hardware is available. Either commercially-available or free PC-based C compilers can be used for software development with the Si114x Programmer's Toolkit API.

The Si114x Programmer's Toolkit API also includes the Si114x Waveform Viewer Application. This tool runs in conjunction with user applications to display and debug the measurements taken from the Si114x Multi-Function Kit.

Note: The Performance Analysis Tool, Si114x Programmer's Toolkit and IDE cannot connect to the Si114x Multi-Function Kit at the same time. Be certain to disconnect from the board in one software package before trying to connect in the other.

3.2.2. Command Line Utilities

For evaluation of the Si114x Multi-Function Kit without the need to develop and compile source code, a flexible set of command line utilities is also provided with the Si114x Programmer's Toolkit. These utilities can be used to configure and read samples from the Si114x Multi-Function Kit. For automated configuration and scripting, the command line utilities can be embedded into .bat files.

3.2.3. Sample Source Code

For faster application development, the Si114x Programmer's Toolkit contains example source code for the Si114x Multi-Function Kit and for each of the command line utilities. Developers can get started quickly by using the Si114x example source code and then tailoring it to their needs.

3.2.4. Downloading the Si114x Programmer's Toolkit

The Si114x Programmer's Toolkit and associated documentation is available from the web at the following URL:

<http://www.silabs.com/products/sensors/pages/optical-sensor-software.aspx>.

3.3. Silicon Laboratories IDE

The Silicon Laboratories IDE integrates a source-code editor, a source-level debugger, and an in-system flash programmer. This tool can be used to develop and debug code for the C8051F931 MCUs which are included on the Si114x Multi-Function Board. The use of several third-party compilers and assemblers is supported by the IDE.

3.3.1. IDE System Requirements

The Silicon Laboratories IDE requirements:

- Pentium-class host PC running Microsoft Windows 2000 or newer.
- Two available USB ports.

3.3.2. Third Party Toolsets

The Silicon Laboratories IDE has native support for many 8051 compilers. The full list of natively supported tools is as follows:

- Keil
- IAR
- Raisonance
- Tasking
- SDCC

3.3.3. Downloading the Example Firmware Image

Source code that has been developed and compiled for the C8051F931 MCU on the Si114x Multi-Function Board may be downloaded to the board using the Silicon Laboratories IDE. Follow the instructions below to update or fresh the .HEX image in the Si114x Multi-Function Board.

1. Connect the Si114x Multi-Function Board to the PC through both USB ports on the board. The connector labeled COMM will provide power to the board while the connector labeled DEBUG will allow programming.
2. Launch the Silicon Labs IDE, and click on *Options->Connection Options*.
3. Select "USB Debug Adapter", and then select the board from the list (it should show up as "TS" followed by a serial number).
4. Select "C2" as the debug interface, and press "OK".
5. Connect to the board by pressing the "Connect" icon or by using the keyboard shortcut, Alt+C.
6. Click on the "Download" icon, or use the keyboard shortcut Alt+D.
7. In the download dialog window, click "Browse".
8. Change to Files of Type "Intel Hex (*.hex)" and then browse to select the file.
9. Click "Open" then "Download".
10. To run the new image, either press "Run" or "Disconnect" in the IDE.

Table 2. Generic Data Channels—Top-Side Thumb-Scroll Application

Name	Label	Type	Description
G0	Mid 1	Midpoint Timestamps	The firmware records the timestamps for the entry and exit times of your thumb across each LED. Then a midpoint is calculated between these points, and the timing between these midpoints is used to determine gestures.
G1	Mid 2		
G2	Mid 3		
G3	MdAvg	Midpoint Average	If all three midpoints are very close to the average of all three, then a tap gesture is detected.
G4	N/A	Unused channels	The unused channels are not in use by software, but they are available in firmware to use as needed.
G5	N/A		
G6	iLED1	LED Drive Current Levels	Each LED driver has a specific LED drive current setting for it. These values are given in units of mA.
G7	iLED2		
G8	iLED3		
G9	VIS	AutoRanging Ambient Outputs	AutoRanging will automatically change the modes of the photodiodes to avoid saturation. When changing modes, the raw data output changes levels, but AutoRanging will scale the raw data so that all measurements are on the same scale. The output from this channel is the processed value which can be used without knowledge of the photodiode modes.
G10	IR		
G11	PS1	AutoRanging PS Outputs	These channels are the AutoRanging PS output from the device. Raw data measurements are processed by the AutoRanging firmware to make all the readings across different modes have the same magnitude. Since the device switches modes to compensate for ambient light, the raw data will show jumps when changing modes. These outputs will not display the jumps because the firmware is stitching the raw outputs together.
G12	PS2		
G13	PS3		
G14	VIS s	State of Ambient Visible System	These channels help indicate what mode the sensor is in during each of their respective measurements. The four possible modes are as follows: Low Light, High Sensitivity, High Signal, and Sunlight. These modes are numbered from zero to three. For more information about each mode, please consult the data sheet.
G15	IR st	State of Ambient IR System	
G16	PS st	State of PS System	
G17	PS1bl	PS Baseline Levels	AutoRanging uses baselining to determine the no-detect threshold for readings. Any readings below the values shown on these channels will be considered no-detect readings. Any values higher than this baseline will be shown in the AutoRanging PS Outputs above.
G18	PS2bl		
G19	PS3bl		
G20	N/A	Unused by PAT	These channels are reserved for use by the Si1140 Control Panel.
G21	N/A		

Table 3. Generic Data Channels—Bottom-Side Ranging Demo

Name	Label	Type	Description
G0	Avg	Average of PS1	The average of PS1 is more stable and allows for smaller thresholds for long-range detection.
G1	Thr	Detection Threshold	A detect is triggered when the Avg exceeds the Thr.
G2	iLED1	LED Drive Current Level	The LED driver has a specific LED drive current setting for it. This value is given in units of mA.
G3	VIS	AutoRanging Ambient Outputs	AutoRanging will automatically change the modes of the photodiodes to avoid saturation. When changing modes, the raw data output changes levels, but AutoRanging will scale the raw data so that all measurements are on the same scale. The output from this channel is the processed value which can be used without knowledge of the photodiode modes.
G4	IR		
G5	PS1	AutoRanging PS Output	This channel is the AutoRanging PS output from the device. This output helps compensate for the affects of high changes in ambient light levels.
G6	VISst	State of Ambient Visible System	These channels help indicate what mode the sensor is in during each of their respective measurements. The four possible modes are as follows: Low Light, High Sensitivity, High Signal, and Sunlight. These modes are numbered from zero to three. For more information about each mode, please consult the data sheet.
G7	IRst	State of Ambient IR System	
G8	PSst	State of PS System	
G9	PS1bl	PS Baseline Levels	
G10	BLVal	Baseline Value	The Bottom-Side Ranging algorithm has its own baselining algorithm that baselines on the Avg (G0) channel. This channel is the current value that the baseline is set to.
G11	BLcnt	Baseline Counter	The baselining algorithm picks a rolling maximum value from Avg (G0) and tests to see if that value can be used as the new baseline. This is the Baseline Test Value. If the Avg does not stray too far away from the BLtst value for 40 samples in a row, this BLtst value will become the new Baseline Value. The sample counter is on G11 as the Baseline Counter value.
G12	BLtst	Baseline Test Value	
G13	N/A	Unused by PAT	These channels are reserved for use by the Si1140 Control Panel.
G14	N/A		

4. Schematic

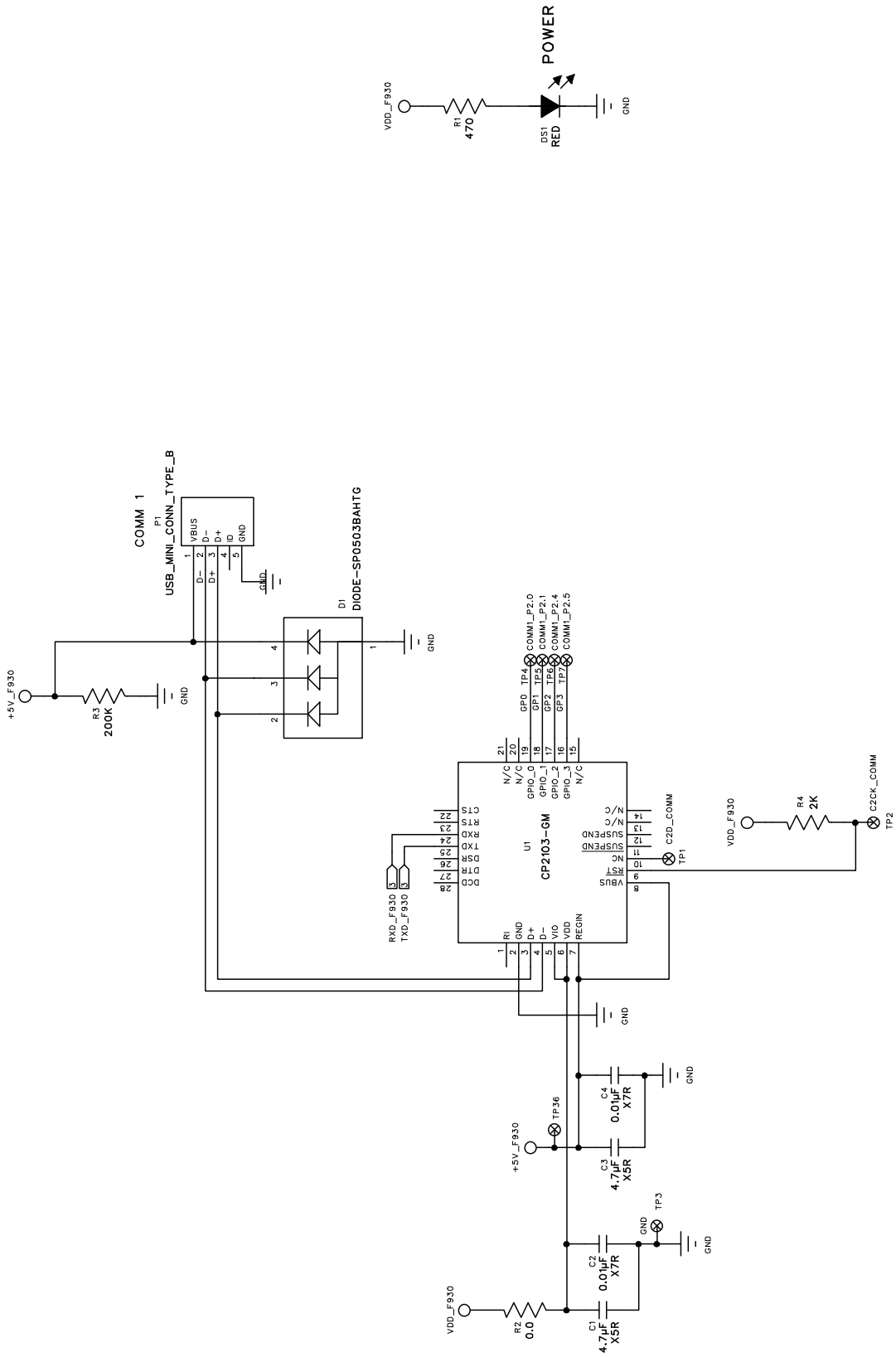

Figure 6. Si1143 Evaluation Board Schematic (1 of 3)

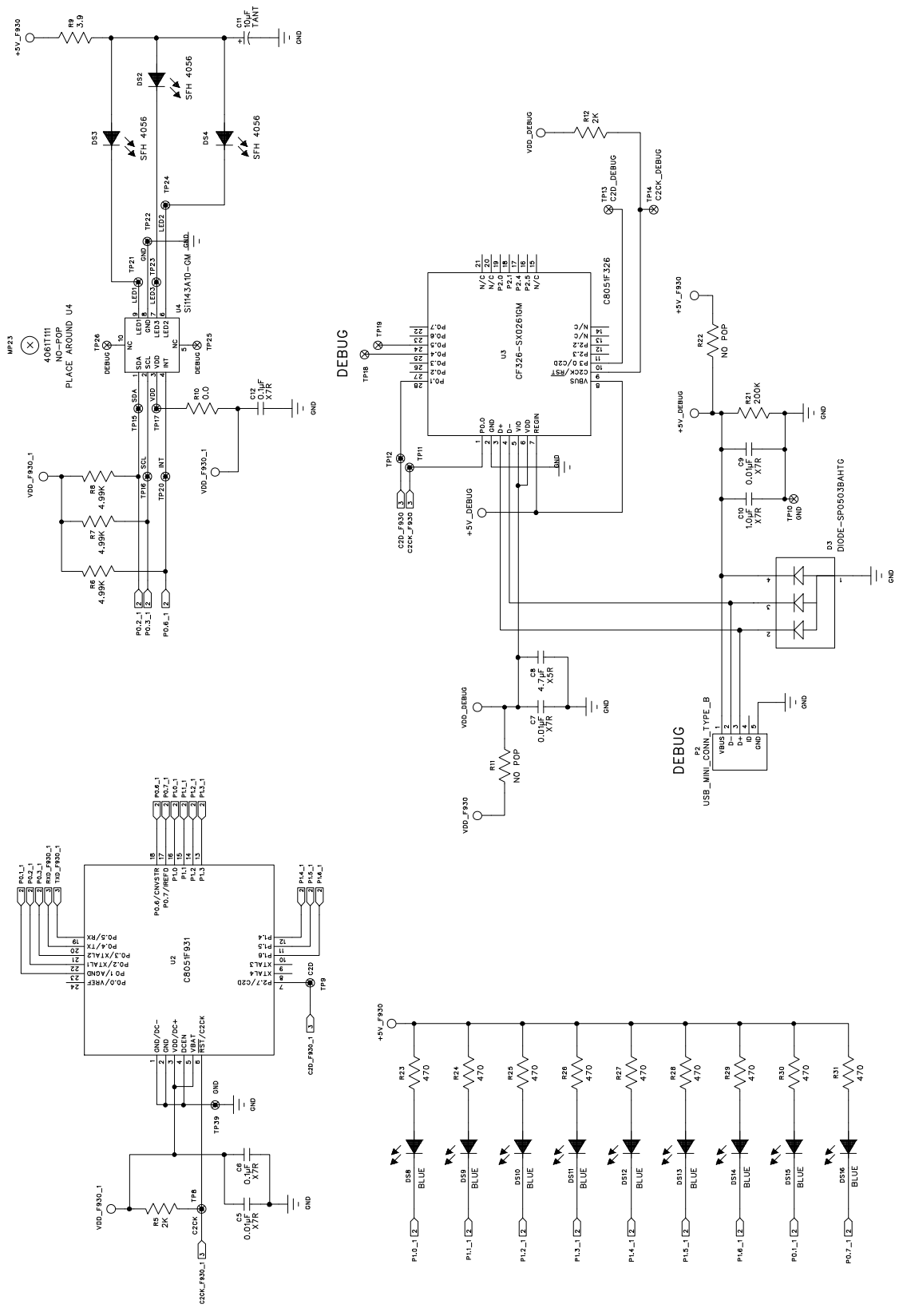

Figure 7. Si1143 Evaluation Board Schematic (2 of 3)

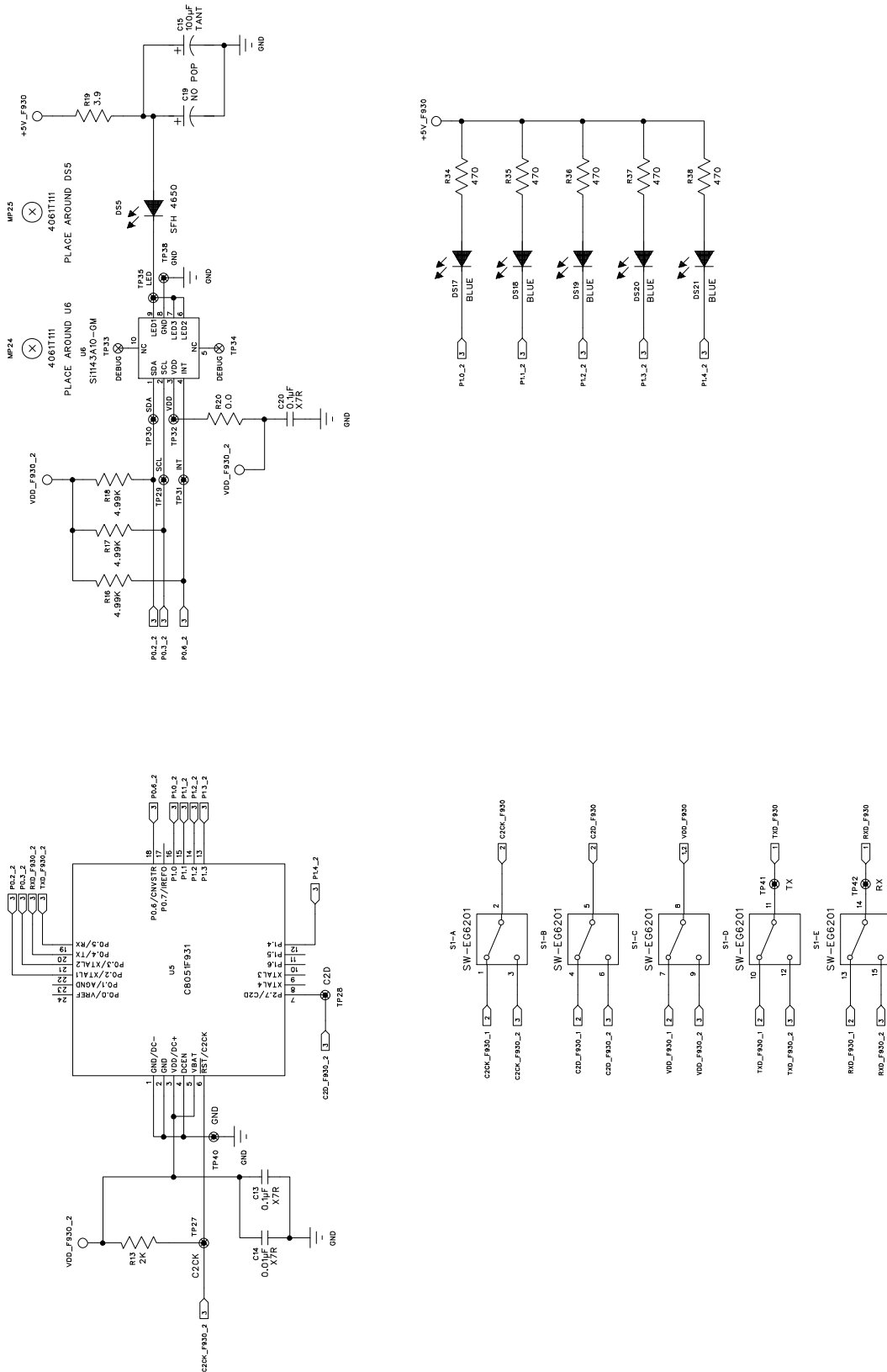

Figure 8. Si1143 Evaluation Board Schematic (3 of 3)

DOCUMENT CHANGE LIST

Revision 0.1 to Revision 0.2

- Replaced QuickSense Studio references and instructions with Si114x Programmer's Toolkit.

NOTES:

CONTACT INFORMATION

Silicon Laboratories Inc.
400 West Cesar Chavez
Austin, TX 78701
Tel: 1+(512) 416-8500
Fax: 1+(512) 416-9669
Toll Free: 1+(877) 444-3032

Please visit the Silicon Labs Technical Support web page:
<https://www.silabs.com/support/pages/contacttechnicalsupport.aspx>
and register to submit a technical support request.

Patent Notice

Silicon Labs invests in research and development to help our customers differentiate in the market with innovative low-power, small size, analog-intensive mixed-signal solutions. Silicon Labs' extensive patent portfolio is a testament to our unique approach and world-class engineering team.

The information in this document is believed to be accurate in all respects at the time of publication but is subject to change without notice. Silicon Laboratories assumes no responsibility for errors and omissions, and disclaims responsibility for any consequences resulting from the use of information included herein. Additionally, Silicon Laboratories assumes no responsibility for the functioning of undescribed features or parameters. Silicon Laboratories reserves the right to make changes without further notice. Silicon Laboratories makes no warranty, representation or guarantee regarding the suitability of its products for any particular purpose, nor does Silicon Laboratories assume any liability arising out of the application or use of any product or circuit, and specifically disclaims any and all liability, including without limitation consequential or incidental damages. Silicon Laboratories products are not designed, intended, or authorized for use in applications intended to support or sustain life, or for any other application in which the failure of the Silicon Laboratories product could create a situation where personal injury or death may occur. Should Buyer purchase or use Silicon Laboratories products for any such unintended or unauthorized application, Buyer shall indemnify and hold Silicon Laboratories harmless against all claims and damages.

Silicon Laboratories and Silicon Labs are trademarks of Silicon Laboratories Inc.
Other products or brandnames mentioned herein are trademarks or registered trademarks of their respective holders.