

# Cree® XLamp® XP-E2 LEDs

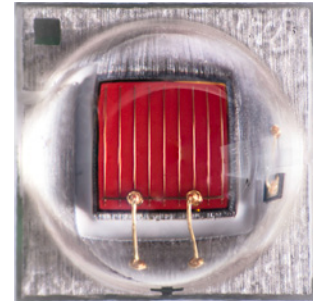
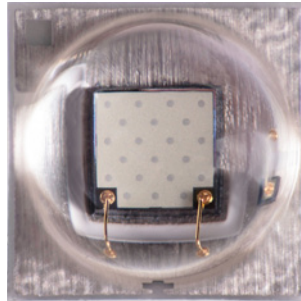
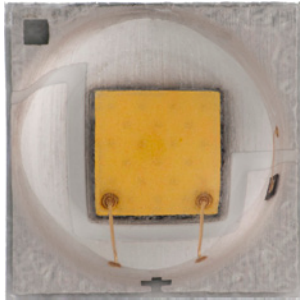

## PRODUCT DESCRIPTION

The XLamp XP-E2 LED builds on the unprecedented performance of the original XP-E by increasing lumen output up to 20% while providing a single die LED point source for precise optical control. The XP-E2 LED shares the same footprint as the original XP-E, providing a seamless upgrade path to more lumens and/or greater efficiency while shortening the design cycle for existing XP customers.

XLamp XP-E2 LEDs are the ideal choice for lighting applications where high light output and maximum efficacy are required, such as LED retrofit lamps, outdoor, portable, indoor directional, emergency vehicle or architectural.

## FEATURES

- Available in white, outdoor white, 80-CRI, 85-CRI, 90-CRI white, royal blue, blue, green, amber, red-orange & red
- ANSI-compatible chromaticity bins
- White binned at 85 °C
- Maximum drive current: 1 A
- Low thermal resistance: as low as 5 °C/W
- Wide viewing angle: 110°-135°
- Unlimited floor life at ≤ 30 °C/85% RH
- Reflow solderable - JEDEC J-STD-020C compatible
- Electrically neutral thermal path
- UL-recognized component (E349212)

## TABLE OF CONTENTS

Characteristics .....	2
Flux Characteristics - White .....	3
Flux Characteristics - Color .....	4
Relative Spectral Power Distribution.....	6
Relative Flux vs. Junction Temperature .....	7
Electrical Characteristics .....	8
Relative Flux vs. Current .....	9
Relative Chromaticity vs. Current and Temperature .....	10
Typical Spatial Distribution.....	11
Thermal Design.....	12
Reflow Soldering Characteristics .	13
Notes.....	14
Mechanical Dimensions.....	15
Tape and Reel .....	16
Packaging.....	17



**CHARACTERISTICS**

Characteristics	Unit	Minimum	Typical	Maximum
Thermal resistance, junction to solder point - white, royal blue, blue	°C/W		9	
Thermal resistance, junction to solder point - green	°C/W		15	
Thermal resistance, junction to solder point - amber	°C/W		7	
Thermal resistance, junction to solder point - red-orange, red	°C/W		5	
Viewing angle (FWHM) - white	degrees		110	
Viewing angle (FWHM) - royal blue, blue, green	degrees		135	
Viewing angle (FWHM) - amber, red-orange, red	degrees		130	
Temperature coefficient of voltage - white	mV/°C		-2.3	
Temperature coefficient of voltage - royal blue, blue	mV/°C		-3.3	
Temperature coefficient of voltage - green	mV/°C		-3.8	
Temperature coefficient of voltage - amber, red-orange, red	mV/°C		-1.8	
ESD withstand voltage (HBM per Mil-Std-883D)- white, royal blue, blue, green	V			8000
ESD classification (HBM per Mil-Std-883D) - amber, red-orange, red			Class 2	
DC forward current	mA			1000
Reverse voltage	V			5
Forward voltage (@ 350 mA, 85 °C) - white	V		2.9	3.25
Forward voltage (@ 700 mA, 85 °C) - white			3.05	
Forward voltage (@ 1000 mA, 85 °C) - white			3.15	
Forward voltage (@ 350 mA, 25 °C) - royal blue, blue	V		3.1	3.5
Forward voltage (@ 350 mA, 25 °C) - green	V		3.2	3.6
Forward voltage (@ 350 mA, 25 °C) - amber, red-orange, red	V		2.2	2.6
Forward voltage (@ 1000 mA, 25 °C) - royal blue, blue	V		3.4	
Forward voltage (@ 1000 mA, 25 °C) - green	V		3.7	
Forward voltage (@ 1000 mA, 25 °C) - amber, red-orange, red	V		2.65	
LED junction temperature	°C			150

**FLUX CHARACTERISTICS (T<sub>j</sub> = 85 °C) - WHITE**

The following table provides several base order codes for XLamp XP-E2 LEDs. It is important to note that the base order codes listed here are a subset of the total available order codes for the product family. For more order codes, as well as a complete description of the order-code nomenclature, please consult the XLamp XP Family Binning and Labeling document.

Color	CCT Range		Base Order Codes Min. Luminous Flux (lm) @ 350 mA			Calculated Minimum Luminous Flux (lm)** @ 85 °C		Order Code
	Min.	Max.	Group	Flux (lm) @ 85 °C	Flux (lm) @ 25 °C*	700 mA	1.0 A	
Cool White	5000 K	10,000 K	Q4	100	116	171	218	XPEBWT-L1-0000-00C51
			Q5	107	124	183	233	XPEBWT-L1-0000-00D51
			R2	114	132	195	249	XPEBWT-L1-0000-00E51
			R3	122	142	209	266	XPEBWT-L1-0000-00F51
Outdoor White	4000 K	5300 K	Q4	100	116	171	218	XPEBWT-01-0000-00CC2
			Q5	107	124	183	233	XPEBWT-01-0000-00DC2
			R2	114	132	195	249	XPEBWT-01-0000-00EC2
			R3	122	142	209	266	XPEBWT-01-0000-00FC2
Neutral White	3700 K	5300 K	Q4	100	116	171	218	XPEBWT-L1-0000-00CE4
			Q5	107	124	183	233	XPEBWT-L1-0000-00DE4
			R2	114	132	195	249	XPEBWT-L1-0000-00EE4
80-CRI White	2200 K	4300 K	Q2	87.4	101	150	191	XPEBWT-H1-0000-00AE7
			Q3	93.9	109	161	205	XPEBWT-H1-0000-00BE7
Warm White	2200 K	3700 K	Q2	87.4	101	150	191	XPEBWT-L1-0000-00AE7
			Q3	93.9	109	161	205	XPEBWT-L1-0000-00BE7
			Q4	100	116	171	218	XPEBWT-L1-0000-00CE7
85-CRI White	2600 K	3200 K	P2	67.2	78.0	115	147	XPEBWT-P1-0000-007E7
			P3	73.9	85.7	127	161	XPEBWT-P1-0000-008E7
			P4	80.6	93.5	138	176	XPEBWT-P1-0000-009E7
			Q2	87.4	101	150	191	XPEBWT-P1-0000-00AE7
90-CRI White	2600 K	3200 K	P2	67.2	78.0	115	147	XPEBWT-U1-0000-007E7
			P3	73.9	85.7	127	161	XPEBWT-U1-0000-008E7
			P4	80.6	93.5	138	176	XPEBWT-U1-0000-009E7

**Notes:**

- Cree maintains a tolerance of ± 7% on flux and power measurements, ±0.005 on chromaticity (CCx, CCy) measurements and ±2 on CRI measurements.
- Typical CRI for Cool White (5000 K – 10,000 K CCT) is 70.
- Typical CRI for Neutral White (3700 K – 5300 K CCT) is 75.
- Typical CRI for Outdoor White (4000 K - 5300 K CCT) is 70.
- Typical CRI for Warm White (2200 K – 3700 K CCT) is 80.
- Minimum CRI for 80-CRI White is 80.
- Minimum CRI for 85-CRI White is 85.
- Minimum CRI for 90-CRI White is 90.
- \* Flux values @ 25 °C are calculated and for reference only.
- \*\* Calculated flux values at 700 mA and 1 A are for reference only.

## FLUX CHARACTERISTICS (T<sub>j</sub> = 25 °C) - COLOR

The following table provides several base order codes for XLamp XP-E2 color LEDs. It is important to note that the base order codes listed here are a subset of the total available order codes for the product family. For more order codes, as well as a complete description of the order-code nomenclature, please consult the XLamp XP Family Binning and Labeling document.

Color	Minimum Radiant Flux @ 350 mA		Dominant Wavelength Range				Order Codes,
	Group	Flux (mW)	Min.		Max.		
			Group	DWL (nm)	Group	DWL (nm)	
Royal Blue	30	450	D3	450	D5	465	XPEBRY-L1-0000-00J01
	31	475	D3	450	D5	465	XPEBRY-L1-0000-00K01
	32	500	D3	450	D5	465	XPEBRY-L1-0000-00L01
	33	525	D3	450	D5	465	XPEBRY-L1-0000-00M01
	34	550	D3	450	D5	465	XPEBRY-L1-0000-00N01
	35	575	D3	450	D5	465	XPEBRY-L1-0000-00P01

Color	Dominant Wavelength Range				Base Order Codes Min. Luminous Flux (lm) @ 350 mA		Order Code
	Min.		Max.		Group	Flux (lm)	
	Group	DWL (nm)	Group	DWL (nm)			
Blue	B3	465	B6	485	K2	30.6	XPEBBL-L1-0000-00Y01
					K3	35.2	XPEBBL-L1-0000-00Z01
					M2	39.8	XPEBBL-L1-0000-00201
					M3	45.7	XPEBBL-L1-0000-00301

Color	Dominant Wavelength Range				Base Order Codes Min. Luminous Flux (lm) @ 350 mA		Order Code
	Min.		Max.		Group	Flux (lm)	
	Group	DWL (nm)	Group	DWL (nm)			
Green	G2	520	G4	535	Q2	87.4	XPEBGR-L1-0000-00A01
					Q3	93.9	XPEBGR-L1-0000-00B01
					Q4	100	XPEBGR-L1-0000-00C01
					Q5	107	XPEBGR-L1-0000-00D01
					R2	114	XPEBGR-L1-0000-00E01
					R3	122	XPEBGR-L1-0000-00F01

Note: Cree maintains a tolerance of  $\pm 7\%$  on flux and power measurements and  $\pm 1$  nm on dominant wavelength measurements.

**FLUX CHARACTERISTICS (T<sub>j</sub> = 25 °C) - COLOR (CONTINUED)**

Color	Dominant Wavelength Range				Base Order Codes Min. Luminous Flux (lm) @ 350 mA		Order Code
	Min.		Max.		Group	Flux (lm)	
	Group	DWL (nm)	Group	DWL (nm)			
Amber	A2	585	A3	595	N4	62.0	XPEBAM-L1-0000-00601
					P2	67.2	XPEBAM-L1-0000-00701
					P3	73.9	XPEBAM-L1-0000-00801
					P4	80.6	XPEBAM-L1-0000-00901

Color	Dominant Wavelength Range				Base Order Codes Min. Luminous Flux (lm) @ 350 mA		Order Code
	Min.		Max.		Group	Flux (lm)	
	Group	DWL (nm)	Group	DWL (nm)			
Red-Orange	O3	610	O4	620	P2	67.2	XPEBRO-L1-0000-00701
					P3	73.9	XPEBRO-L1-0000-00801
					P4	80.6	XPEBRO-L1-0000-00901
					Q2	87.4	XPEBRO-L1-0000-00A01
					Q3	93.9	XPEBRO-L1-0000-00B01

Color	Dominant Wavelength Range				Base Order Codes Min. Luminous Flux (lm) @ 350 mA		Order Code
	Min.		Max.		Group	Flux (lm)	
	Group	DWL (nm)	Group	DWL (nm)			
Red	R2	620	R3	630	N3	56.8	XPEBRD-L1-0000-00501
					N4	62.0	XPEBRD-L1-0000-00601
					P2	67.2	XPEBRD-L1-0000-00701
					P3	73.9	XPEBRD-L1-0000-00801

Note: Cree maintains a tolerance of ± 7% on flux and power measurements and ± 1 nm on dominant wavelength measurements.

**RELATIVE SPECTRAL POWER DISTRIBUTION**

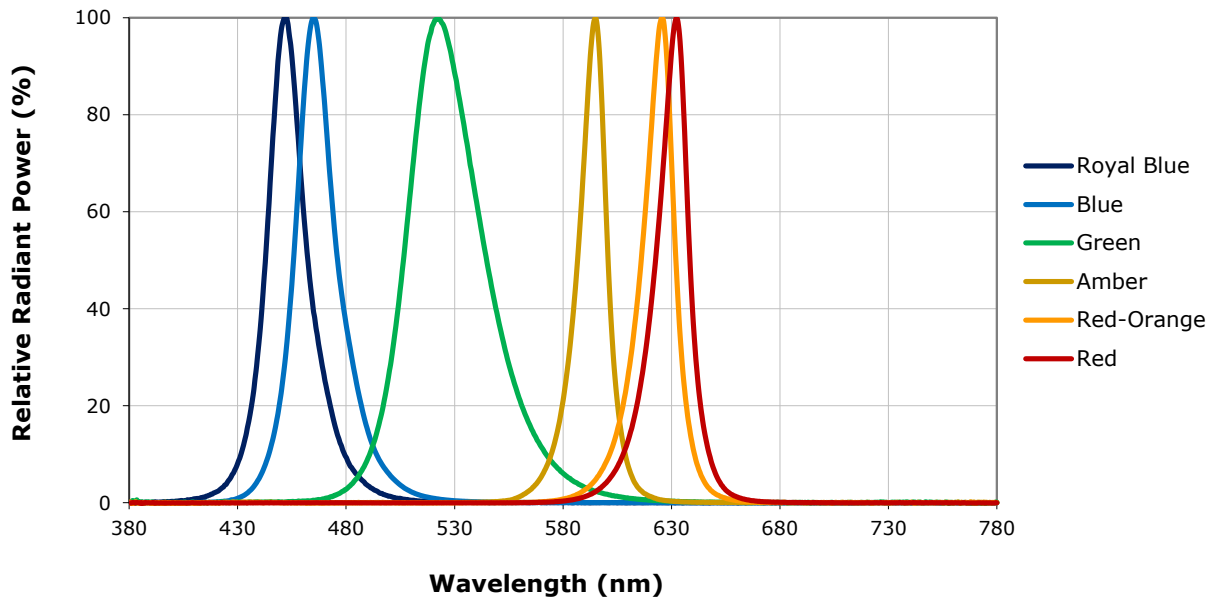
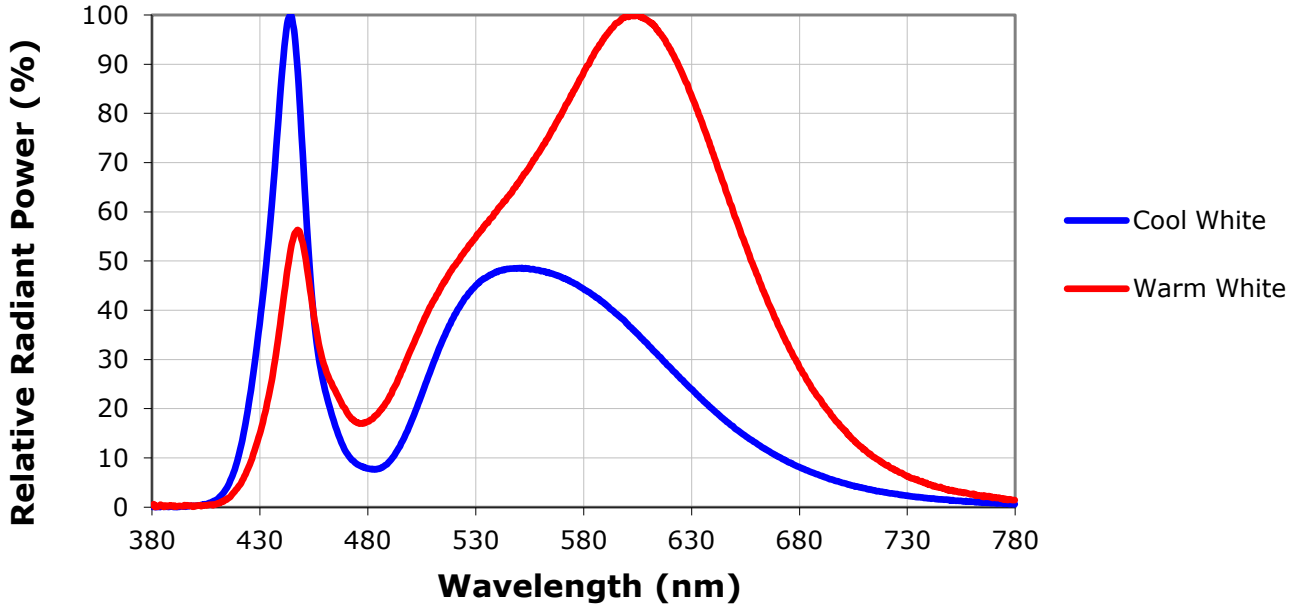

**RELATIVE FLUX VS. JUNCTION TEMPERATURE ( $I_F = 350$  mA)**

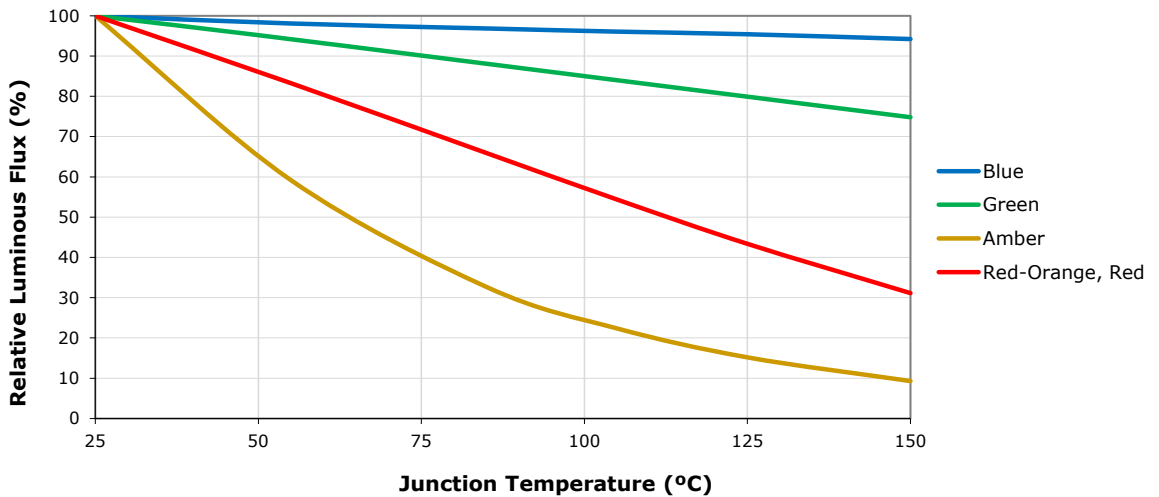
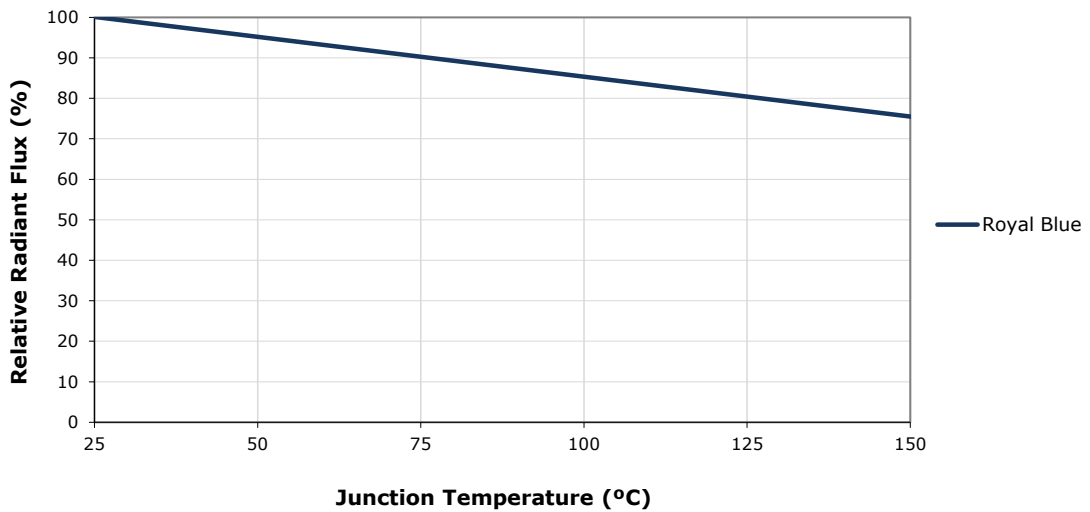
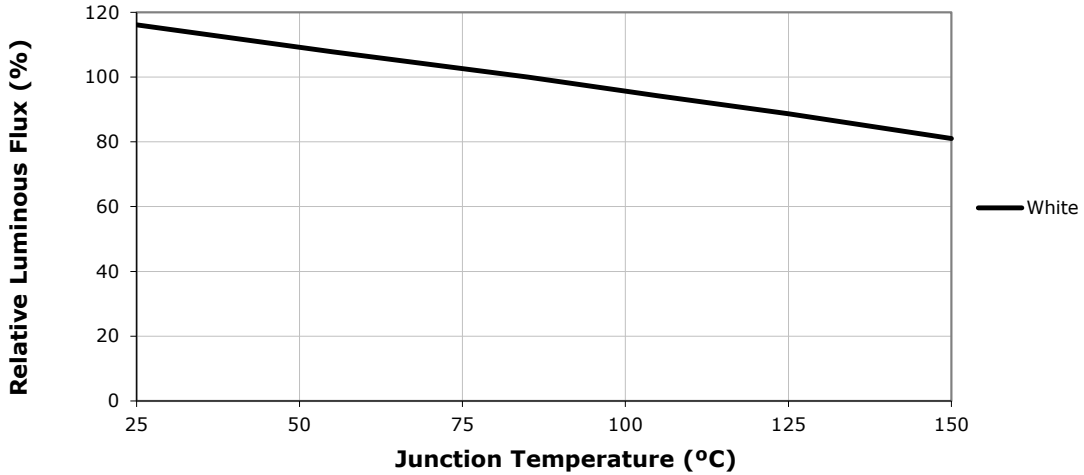

**ELECTRICAL CHARACTERISTICS ( $T_j = 85\text{ }^\circ\text{C}$ )**

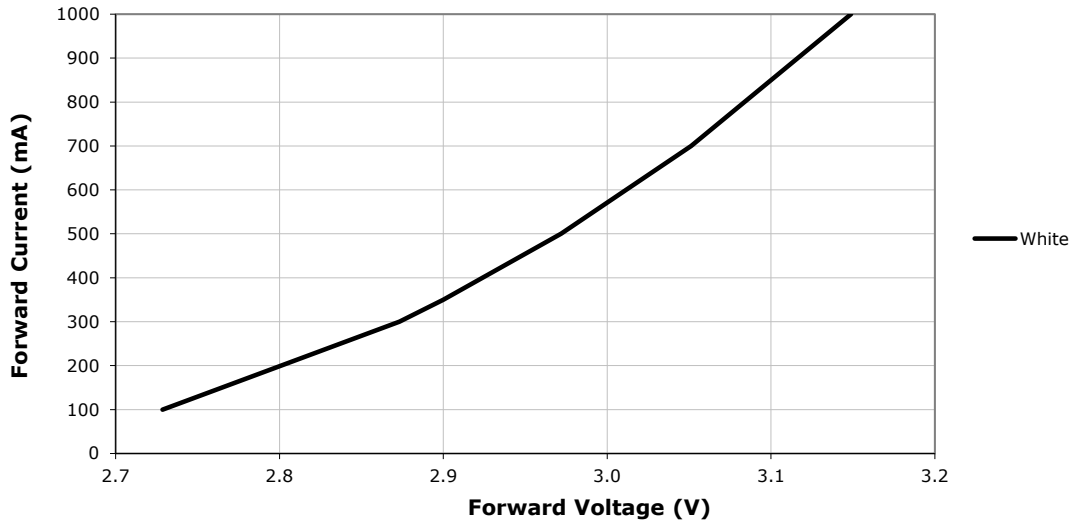

**ELECTRICAL CHARACTERISTICS ( $T_j = 25\text{ }^\circ\text{C}$ )**

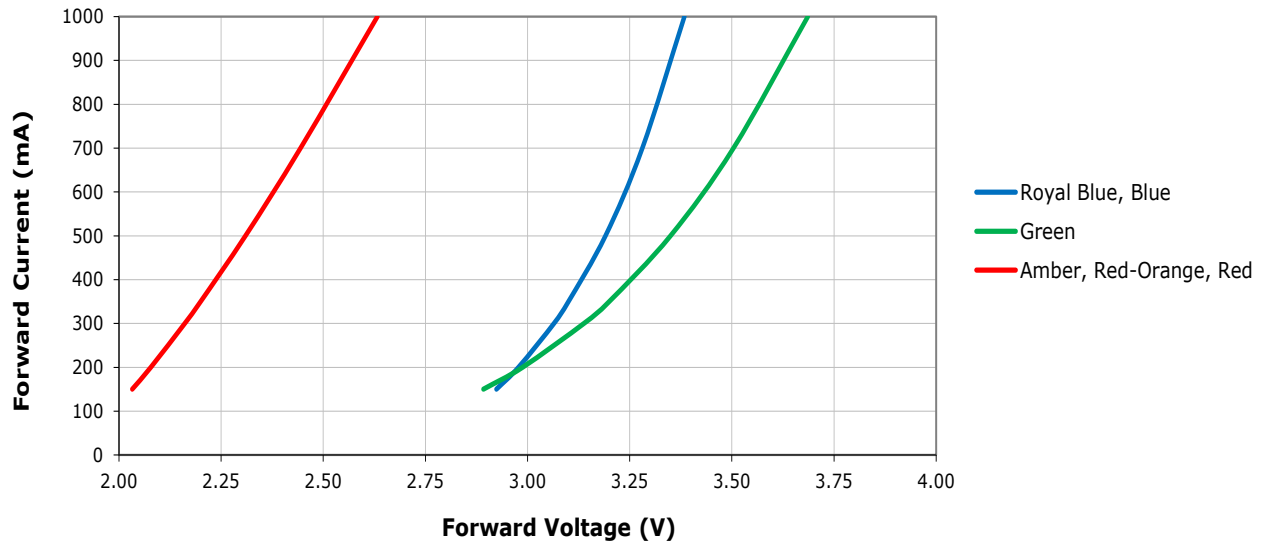



**RELATIVE FLUX VS. CURRENT ( $T_j = 85\text{ }^\circ\text{C}$ )**

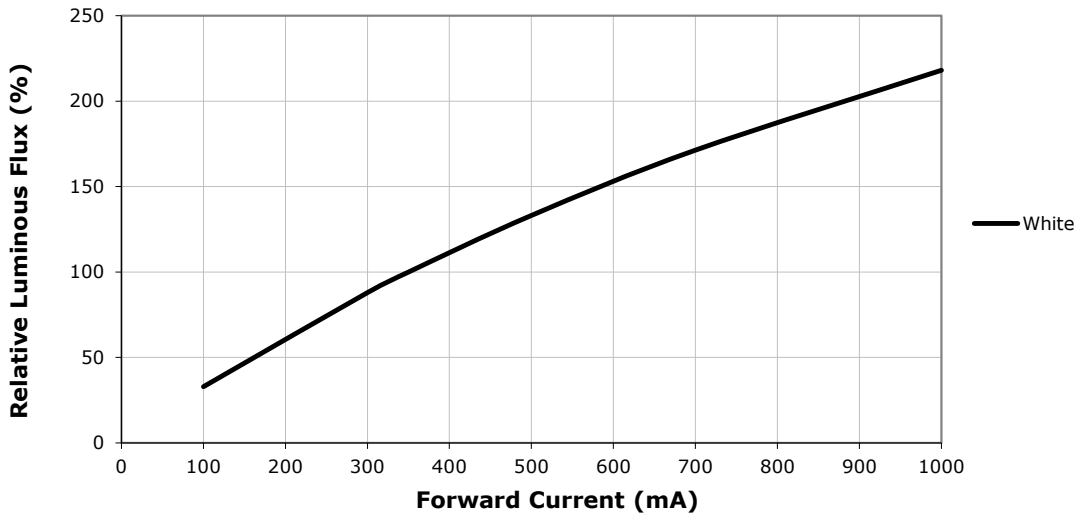

**RELATIVE FLUX VS. CURRENT ( $T_j = 25\text{ }^\circ\text{C}$ )**

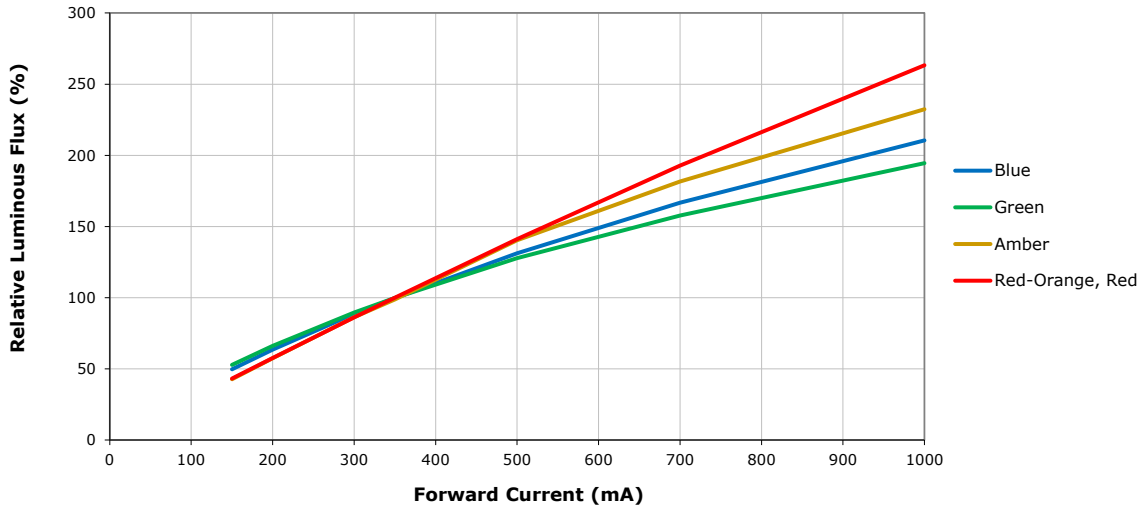
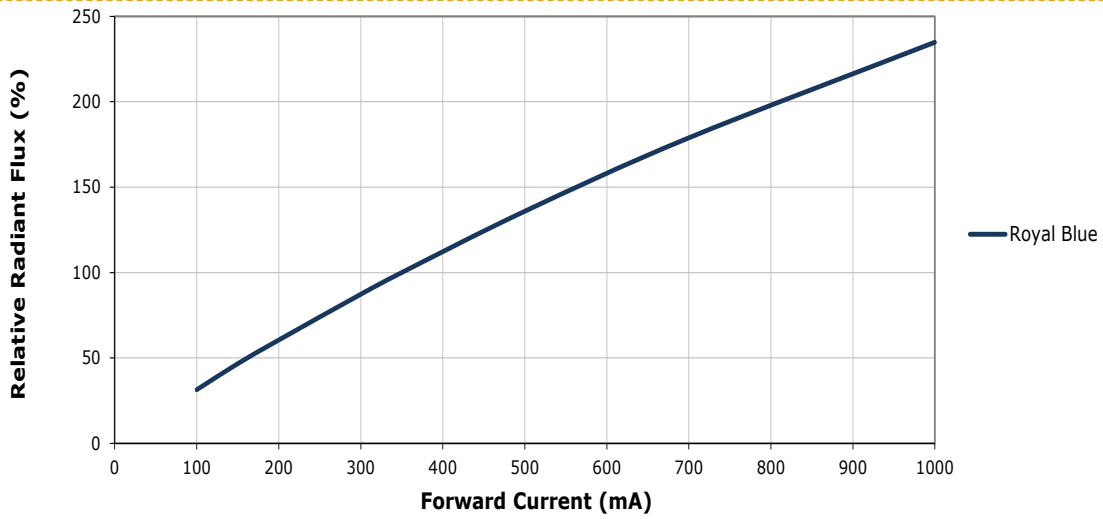

**RELATIVE CHROMATICITY VS. CURRENT AND TEMPERATURE - WARM WHITE\***

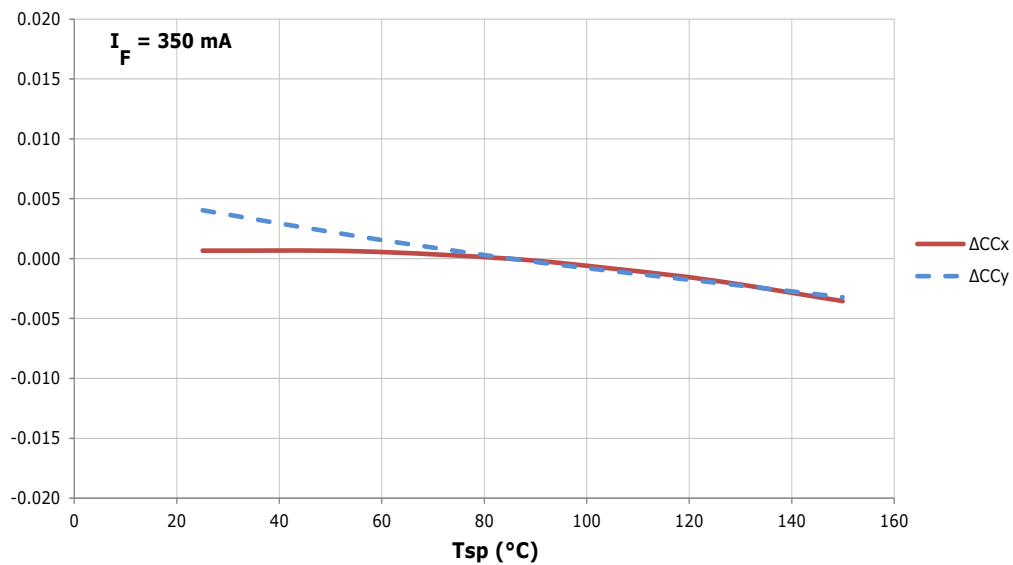
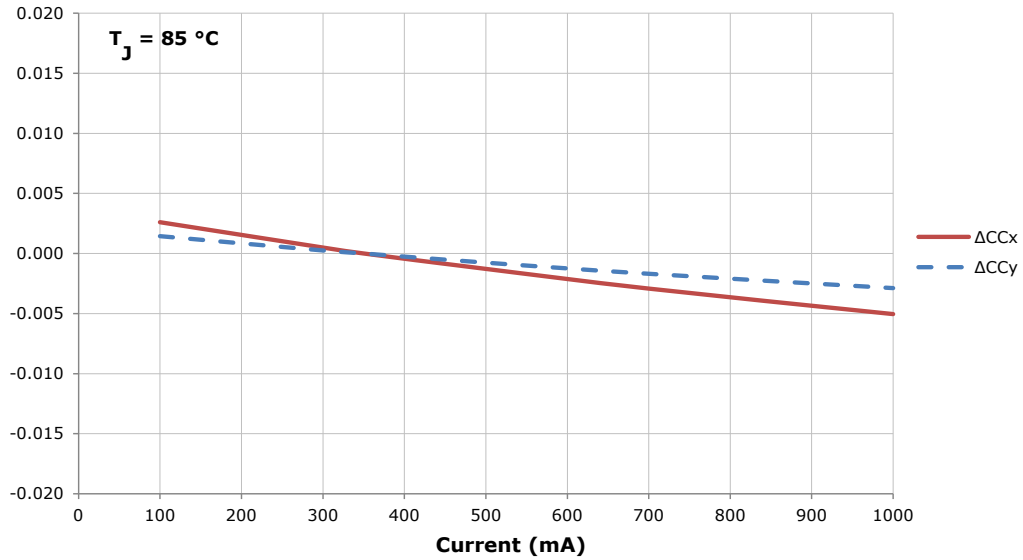

\* Warm White XLamp XP-E2 LEDs have a typical CRI of 80.

**TYPICAL SPATIAL DISTRIBUTION**

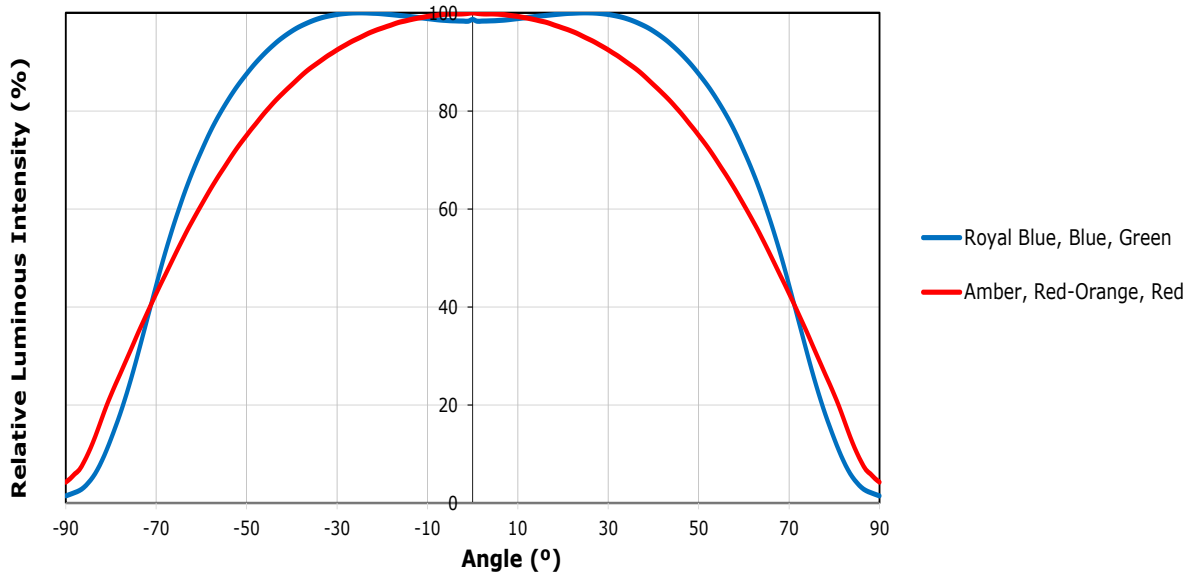
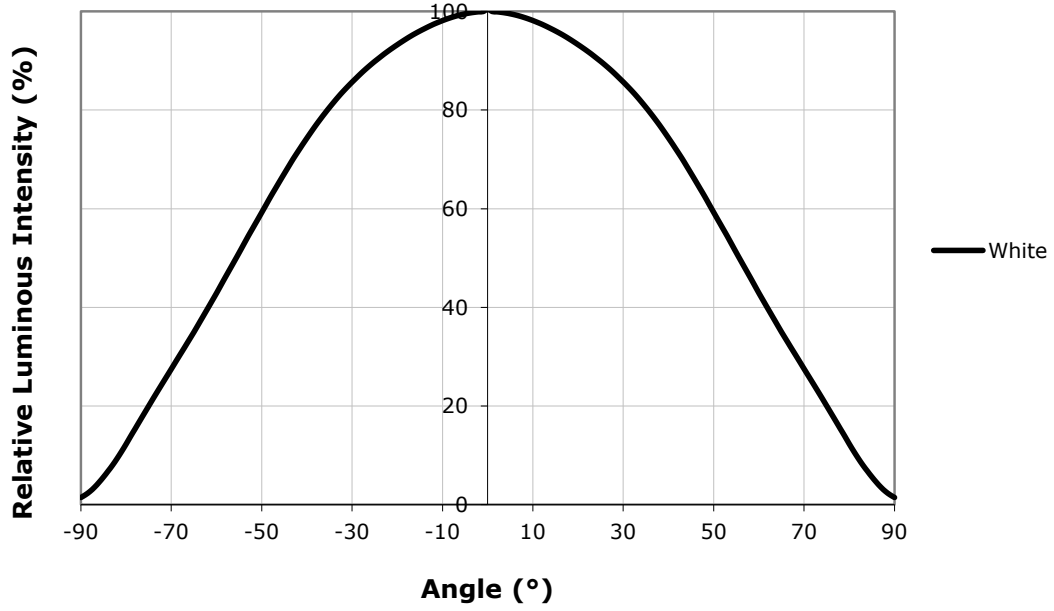

**THERMAL DESIGN**

The maximum forward current is determined by the thermal resistance between the LED junction and ambient. It is crucial for the end product to be designed in a manner that minimizes the thermal resistance from the solder point to ambient in order to optimize lamp life and optical characteristics.

**White**

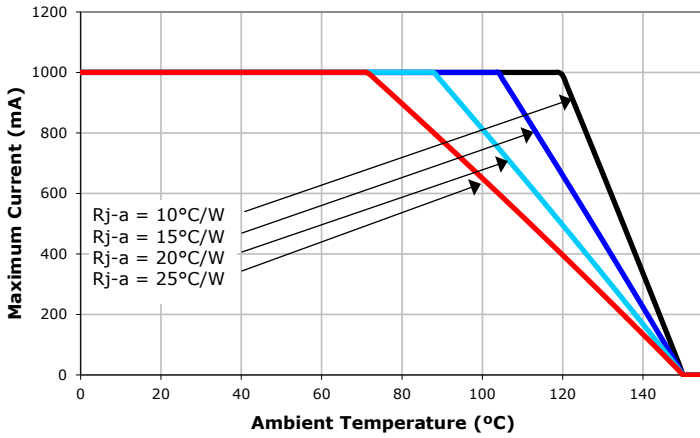

**Royal Blue, Blue**

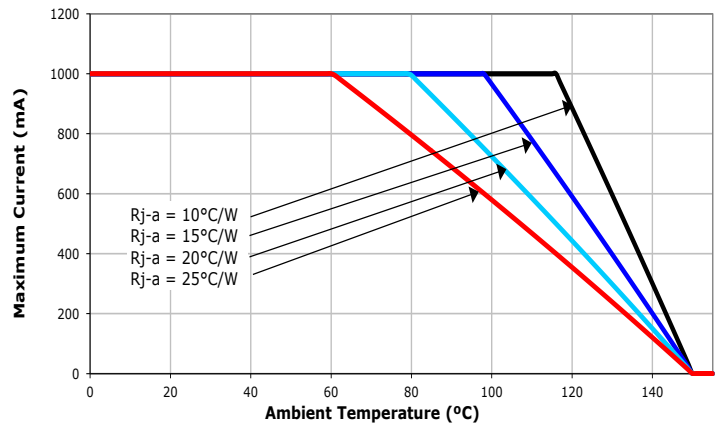

**Green**

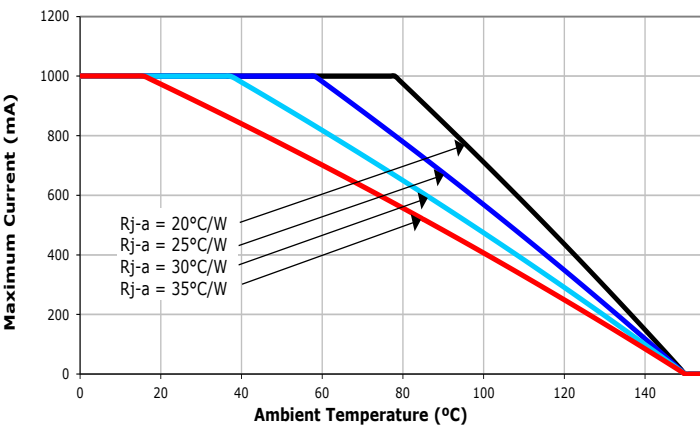

**Amber, Red-Orange, Red**

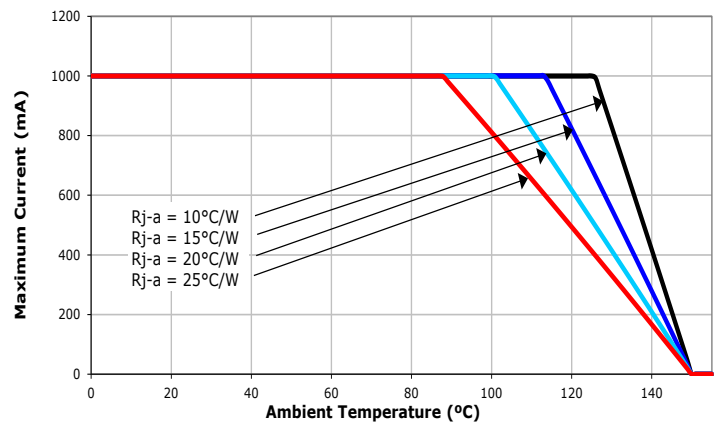

## REFLOW SOLDERING CHARACTERISTICS

In testing, Cree has found XLamp XP-E2 LEDs to be compatible with JEDEC J-STD-020C, using the parameters listed below. As a general guideline, Cree recommends that users follow the recommended soldering profile provided by the manufacturer of solder paste used.

Note that this general guideline may not apply to all PCB designs and configurations of reflow soldering equipment.

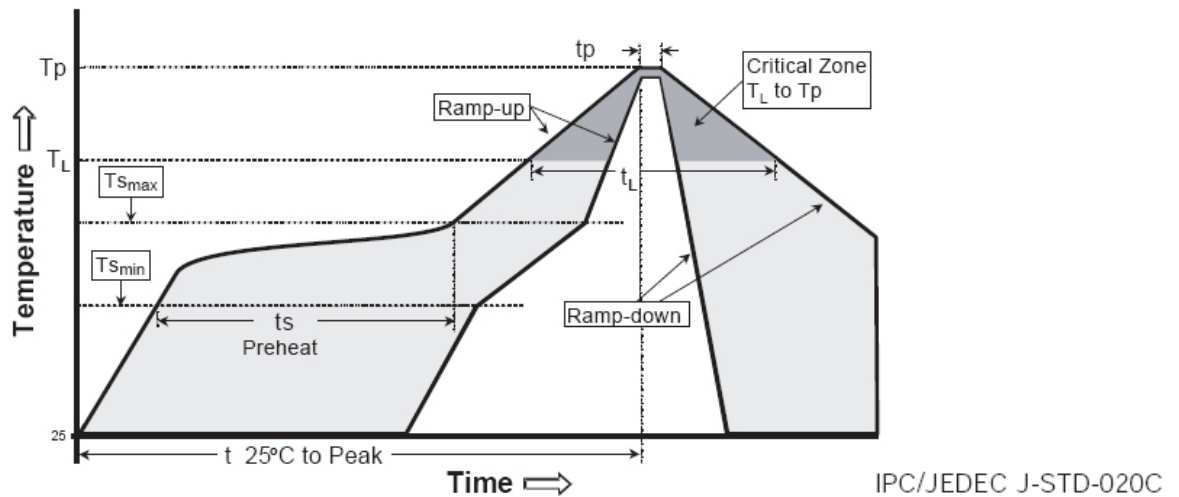

Profile Feature	Lead-Based Solder	Lead-Free Solder
Average Ramp-Up Rate ( $T_{s_{max}}$ to $T_p$ )	3 °C/second max.	3 °C/second max.
Preheat: Temperature Min ( $T_{s_{min}}$ )	100 °C	150 °C
Preheat: Temperature Max ( $T_{s_{max}}$ )	150 °C	200 °C
Preheat: Time ( $t_{s_{min}}$ to $t_{s_{max}}$ )	60-120 seconds	60-180 seconds
Time Maintained Above: Temperature ( $T_L$ )	183 °C	217 °C
Time Maintained Above: Time ( $t_L$ )	60-150 seconds	60-150 seconds
Peak/Classification Temperature ( $T_p$ )	215 °C	260 °C
Time Within 5 °C of Actual Peak Temperature ( $t_p$ )	10-30 seconds	20-40 seconds
Ramp-Down Rate	6 °C/second max.	6 °C/second max.
Time 25 °C to Peak Temperature	6 minutes max.	8 minutes max.

Note: All temperatures refer to topside of the package, measured on the package body surface.

## NOTES

---

### **Lumen Maintenance Projections**

Cree now uses standardized IES LM-80-08 and TM-21-11 methods for collecting long-term data and extrapolating LED lumen maintenance. For information on the specific LM-80 data sets available for this LED, refer to the public LM-80 results document at [www.cree.com/xlamp\\_app\\_notes/LM80\\_results](http://www.cree.com/xlamp_app_notes/LM80_results).

Please read the XLamp Long-Term Lumen Maintenance application note at [www.cree.com/xlamp\\_app\\_notes/lumen\\_maintenance](http://www.cree.com/xlamp_app_notes/lumen_maintenance) for more details on Cree's lumen maintenance testing and forecasting. Please read the XLamp Thermal Management application note at [www.cree.com/xlamp\\_app\\_notes/thermal\\_management](http://www.cree.com/xlamp_app_notes/thermal_management) for details on how thermal design, ambient temperature, and drive current affect the LED junction temperature.

### **Moisture Sensitivity**

In testing, Cree has found XLamp XP-E2 LEDs to have unlimited floor life in conditions  $\leq 30$  °C/85% relative humidity (RH). Moisture testing included a 168-hour soak at 85 °C/85% RH followed by 3 reflow cycles, with visual and electrical inspections at each stage.

Cree recommends keeping XLamp LEDs in their sealed moisture-barrier packaging until immediately prior to use. Cree also recommends returning any unused LEDs to the resealable moisture-barrier bag and closing the bag immediately after use.

### **UL Recognized Component**

Level 4 enclosure consideration. The LED package or a portion thereof has been investigated as a fire and electrical enclosure per ANSI/UL 8750.

### **Vision Advisory Claim**

WARNING: Do not look at exposed lamp in operation. Eye injury can result. See LED Eye Safety at [www.cree.com/xlamp\\_app\\_notes/led\\_eye\\_safety](http://www.cree.com/xlamp_app_notes/led_eye_safety).

**MECHANICAL DIMENSIONS**

All measurements are  $\pm .13$  mm unless otherwise indicated.

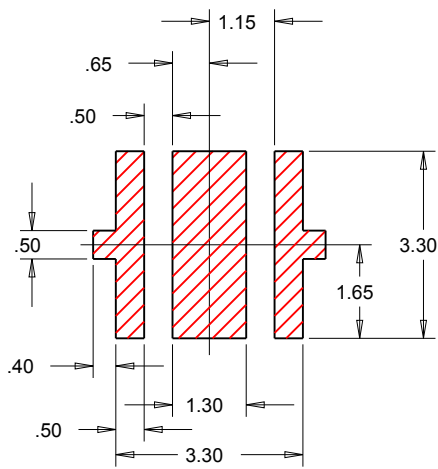
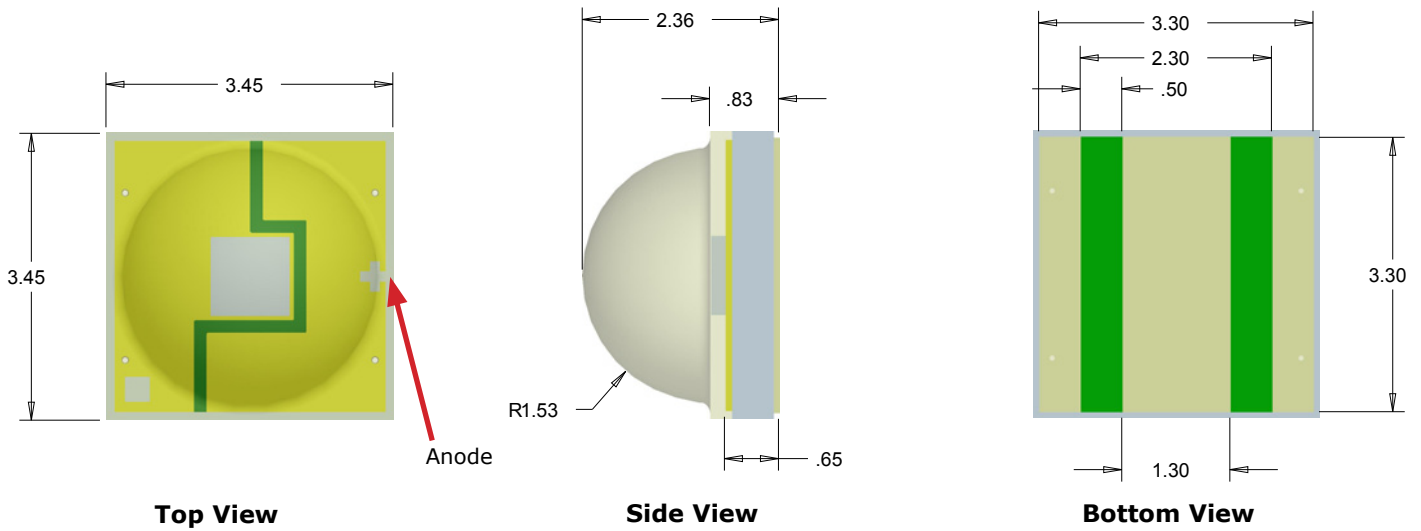
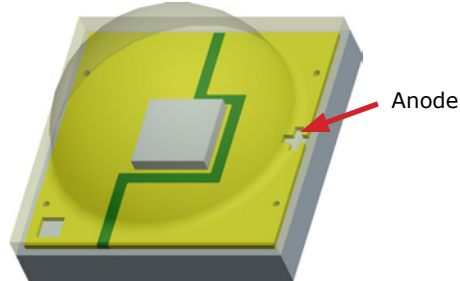

**Recommended PCB Solder Pad**

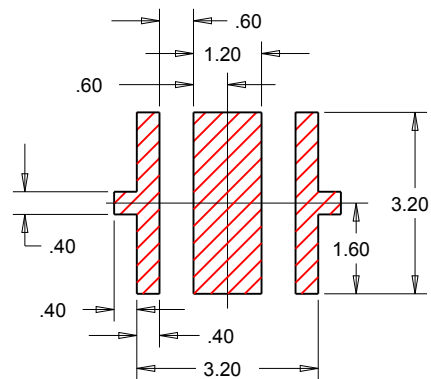

**Recommended Stencil Pattern**  
Hatched Area is Opening

**TAPE AND REEL**

All Cree carrier tapes conform to EIA-481D, Automated Component Handling Systems Standard.

All dimensions in mm.

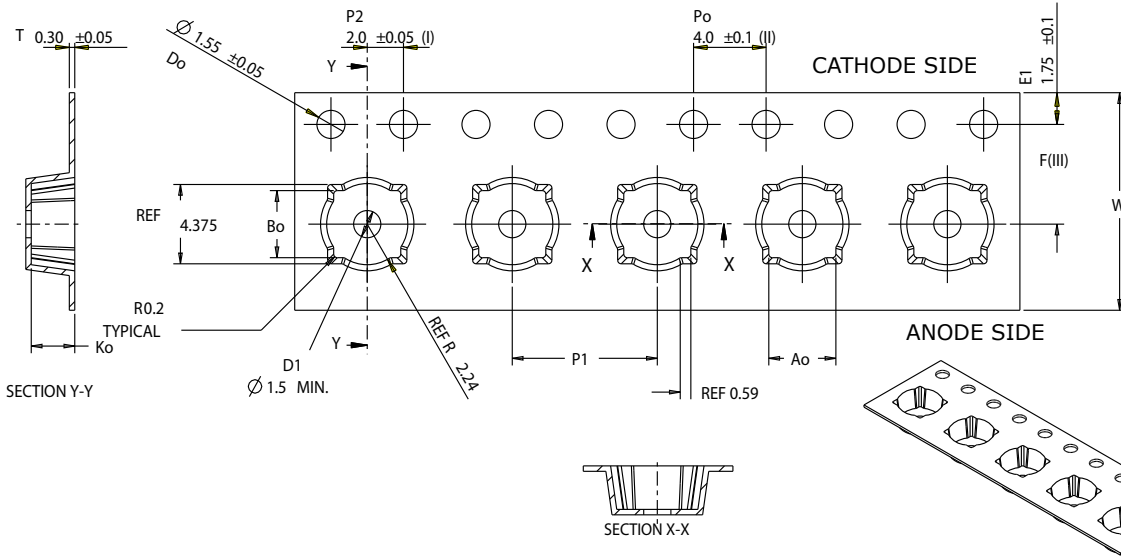

Ao	3.70	+/- 0.1
Bo	3.70	+/- 0.1
Ko	2.40	+0.0/-0.1
F	5.50	+/- 0.05
P <sub>1</sub>	8.00	+/- 0.1
W	12.00	+0.3/-0.1

- (I) Measured from centerline of sprocket hole to centerline of pocket.
- (II) Cumulative tolerance of 10 sprocket holes is  $\pm 0.20$ .
- (III) Measured from centerline of sprocket hole to centerline of pocket.
- (IV) Other material available.

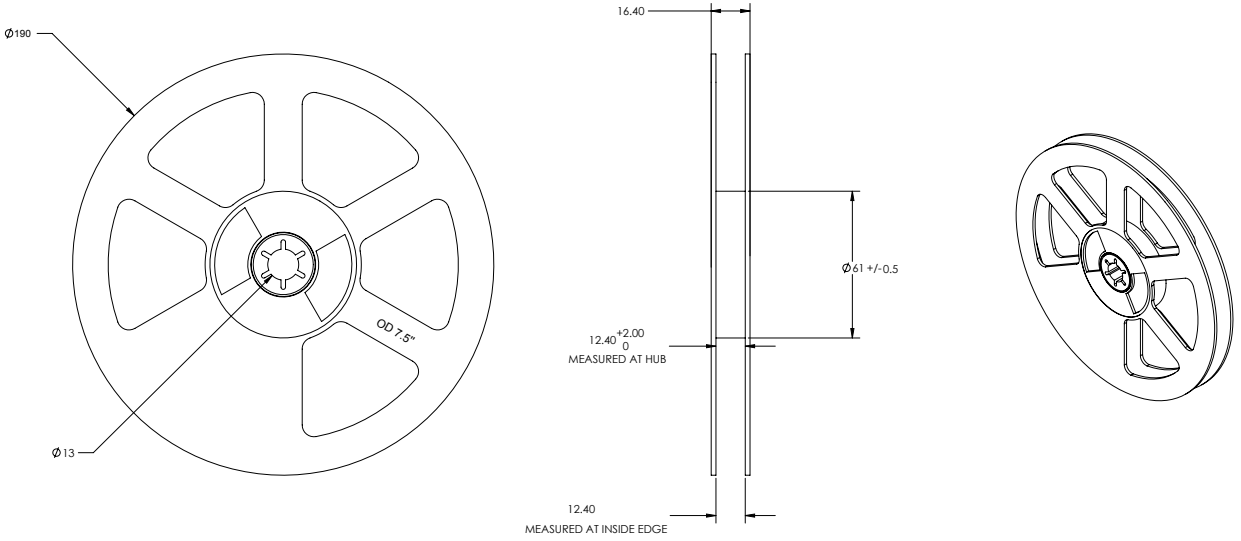
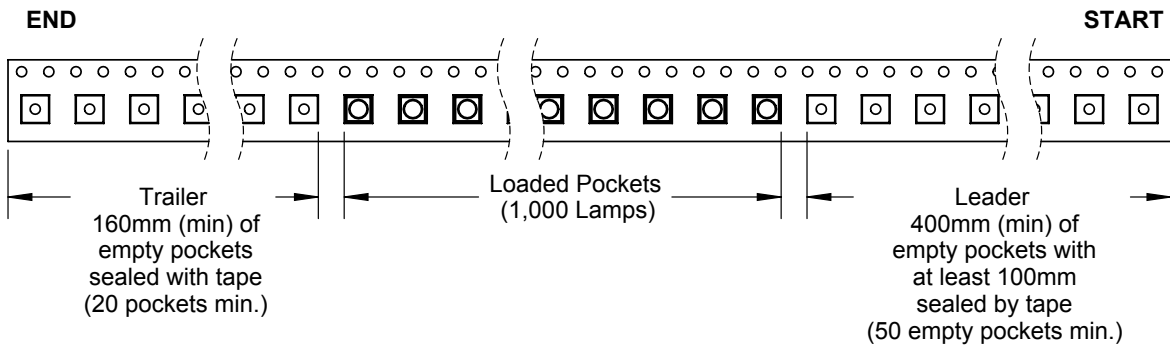



### PACKAGING

#### Unpackaged Reel

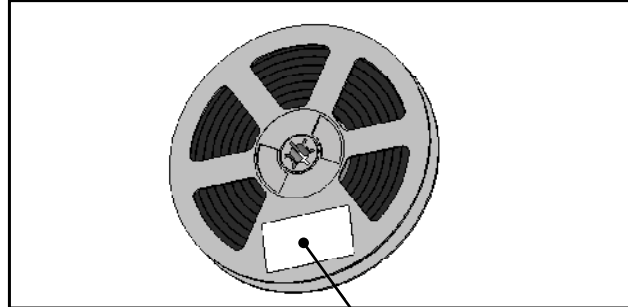

Label with Cree Bin Code, Qty, Reel ID

#### Packaged Reel

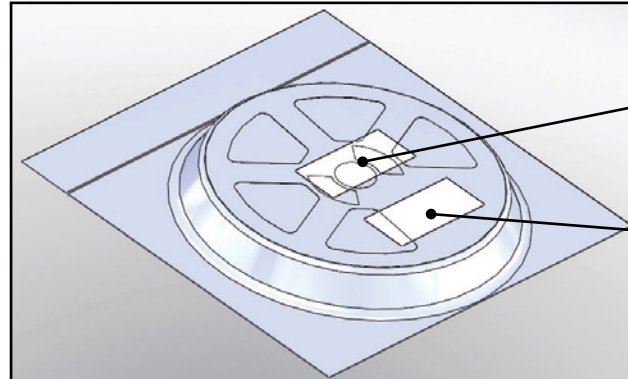

Label with Cree Order Code, Qty, Reel ID, PO #

Label with Cree Bin Code, Qty, Reel ID

#### Boxed Reel

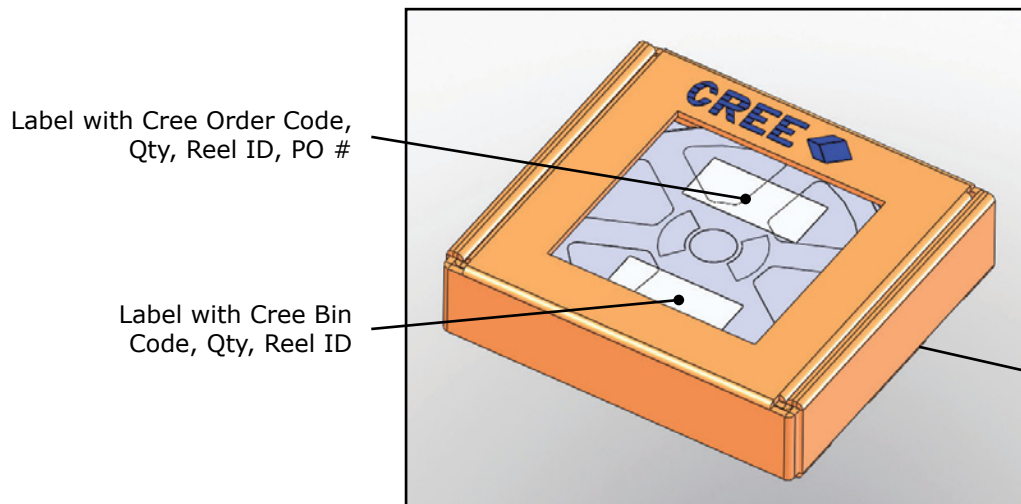

Label with Cree Order Code, Qty, Reel ID, PO #

Label with Cree Bin Code, Qty, Reel ID

Patent Label (on bottom of box)