

## General Description

ISL88550A integrates a synchronous buck PWM controller to generate VDDQ, a sourcing and sinking LDO linear regulator to generate VTT, and a 10mA reference output buffer to generate VTTR. The buck controller drives two external N-Channel MOSFETs to generate output voltages down to 0.7V from a 2V to 25V input with output currents up to 15A. The LDO can sink or source up to 1.5A continuous and 2.5A peak current with fast response. Both the LDO output and the 10mA reference buffer output can be made to track the VREFIN voltage via a built-in resistive divider. These features make the ISL88550A ideally suited for DDR memory applications in desktops, notebooks and graphic cards.

The PWM controller in the ISL88550A uses constant-on-time PWM architecture with a programmable switching frequency of up to 600kHz. This control scheme handles wide input/output voltage ratios with ease and provides 100ns "instant-on" response to load transients while maintaining high efficiency and a relatively constant switching frequency. The ISL88550A offers full programmable UVP/OVP and skip mode options ideal in portable applications. Skip mode allows for improved efficiency at lighter loads.

The VTT and VTTR outputs track to within 1% of VREFIN/2. The high bandwidth of this LDO regulator allows excellent transient response without the need for bulk capacitors, thus reducing the cost and size.

## Pinout

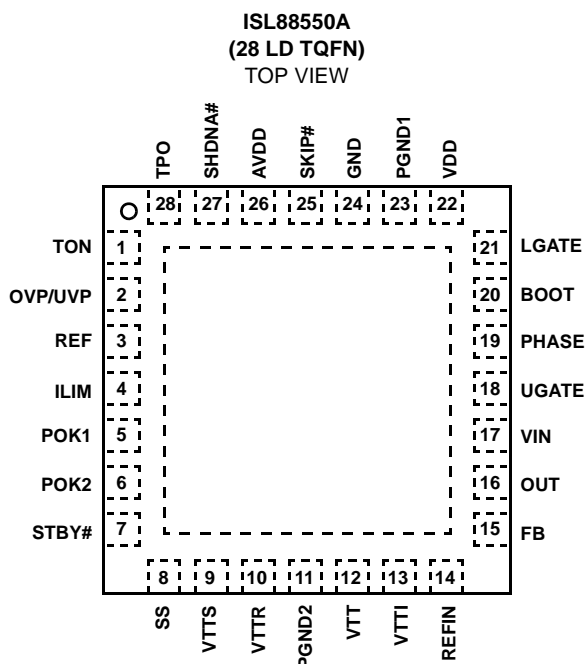

## Features

### Buck Controller

- Constant-On PWM with 100ns Load-Step Response
- Up to 95% Efficiency
- 2V to 25V Input Voltage Range
- 1.8V/2.5V fixed or 0.7V to 3.5V Adjustable Output
- 200kHz, 300kHz, 450kHz, 600kHz Switching Frequencies
- Programmable Current Limit with Foldback Capability
- 1.7ms Digital Soft-Start and Independent Shutdown
- Overvoltage/Undervoltage Protection Option
- Power-Good Window Comparator

### LDO Section

- Fully Integrated VTT and VTTR Capability
- VTT has  $\pm 2.5A$  Sourcing/Sinking Capability
- VTT and VTTR Outputs Track VREFIN/2
- VTT and VTTR within 1% of VREFIN/2
- All Ceramic Output Capacitor Designs
- 1.0V to 2.8V Input VREFIN Range
- Analog Soft-Start Option and Independent Shutdown
- Power-Good Window Comparator

## Applications

- DDR I and DDR II Memory Power Supplies
- Desktop Computers
- Notebooks and Desksnotes
- Graphics Cards
- Game Consoles
- Networking and RAID

## Ordering Information

PART	PACKAGE
ISL88550AEVAL1Z	Evaluation Board

## What's Inside

The Evaluation Board Kit contains the following materials:

- The ISL88550AEVAL1Z REVA board
- The ISL88550A data sheet
- ISL88550AEVAL1Z Kit (this document)

## Recommended Equipment

The following materials are recommended to perform testing:

- 0V to 22V power supply with at least 15A source current capability, battery, notebook AC-adaptor
- 5V Bias supply for VDD
- Two electronic loads capable of sinking current up to 15A
- Dummy loads for the LDO's
- Digital multimeters (DMMs)
- 100MHz quad-trace oscilloscope
- Signal generator

## Quick Setup Guide

1. Ensure that the circuit is correctly connected to the supply and loads prior to applying any power.
2. Connect the bias supply to VDD, the + terminal to P3 (VDD) and - return to TP5 (AGND).
3. Verify that position 2's are ON for SW1, SW2, SW3, and SW5. Verify that position 1 is ON for SW4. Make sure that no other switch position is ON at the same time.
4. Turn on the VIN power supply.
5. Turn on 5V bias supply.
6. Verify the outputs voltages are 1.8V for VDDQ and 0.9V for VTT.

## Evaluating the Other Output Voltage

The ISL88550EVAL1Z kit outputs are preset to 1.8V and 0.9V; however, VDDQ output voltage can be adjusted from 0.8V to 3.5V by using Equation 1:

$$R_{10} = (R_8 / [(V_{OUT}/V_{FB}) - 1]) \quad (\text{EQ. 1})$$

Set R8 to 25kΩ; and VFB to 0.7V

VDDQ output can also be set to 2.5V by shorting FB pin to GND with R10.

VTT output voltage is half on VDDQ in DDR application. VTTI can be powered directly from VDDQ. For better efficiency, VTTI can be powered from an external power supply. Make sure that R13 is removed.

**TABLE 1. SWITCH 1 SETTINGS**

SW1	SKIP	OPERATING MODE
1	Connect to GND	Normal operation mode, allow automatic PWM/PFM switchover for pulse-skipping at light load.
2	Connect to AVDD	Low noise, fixed-frequency PWM mode.
3	No Connection	NA

NOTE: Only toggle one position at a time

**TABLE 2. SWITCH 2 SETTINGS**

SW2	SHDNA#	SHUTDOWN CONTROL
1	Connect to GND	Shutdown mode. VDDQ, VTTR, and VTT output.
2	Connect to AVDD	Enable ISL88550. Rising edge clear the fault protection. Connect to AVDD for normal operation.
3	No Connection	NA

NOTE: Only toggle one position at a time

**TABLE 3. SWITCH 3 SETTINGS**

SW3	t <sub>ON</sub>	t <sub>ON</sub> ON-TIME SELECTION
1	Connect to GND.	t <sub>ON</sub> set to 600kHz frequency
2	Connect to AVDD.	t <sub>ON</sub> set to 200kHz frequency
3	Connect to REF.	t <sub>ON</sub> set to 450kHz frequency
-	OPEN	t <sub>ON</sub> set to 300kHz frequency

NOTE: Only toggle one position at a time

**TABLE 4. SWITCH 4 SETTINGS**

SW4	OVP/UVP	FAULT PROTECTION CONTROL
1	Connect to GND	Disable OVP and UVP
2	Connect to AVDD	Enable OVP and UVP
3	Connect to REF	Disable OVP and enable UVP
-	OPEN	Enable OVP and disable UVP

NOTE: Only toggle one position at a time

**TABLE 5. SWITCH 5 SETTINGS**

SW5	STBY#	FAULT PROTECTION CONTROL
1	Connect to GND	Shutdown VTT in high impedance state. VTTR is still active.
2	Connect to V <sub>CC</sub>	Enable VTT
3	No Connection	

NOTE: Only toggle one position at a time

# ISL88550AEVAL1Z Schematic DDR II

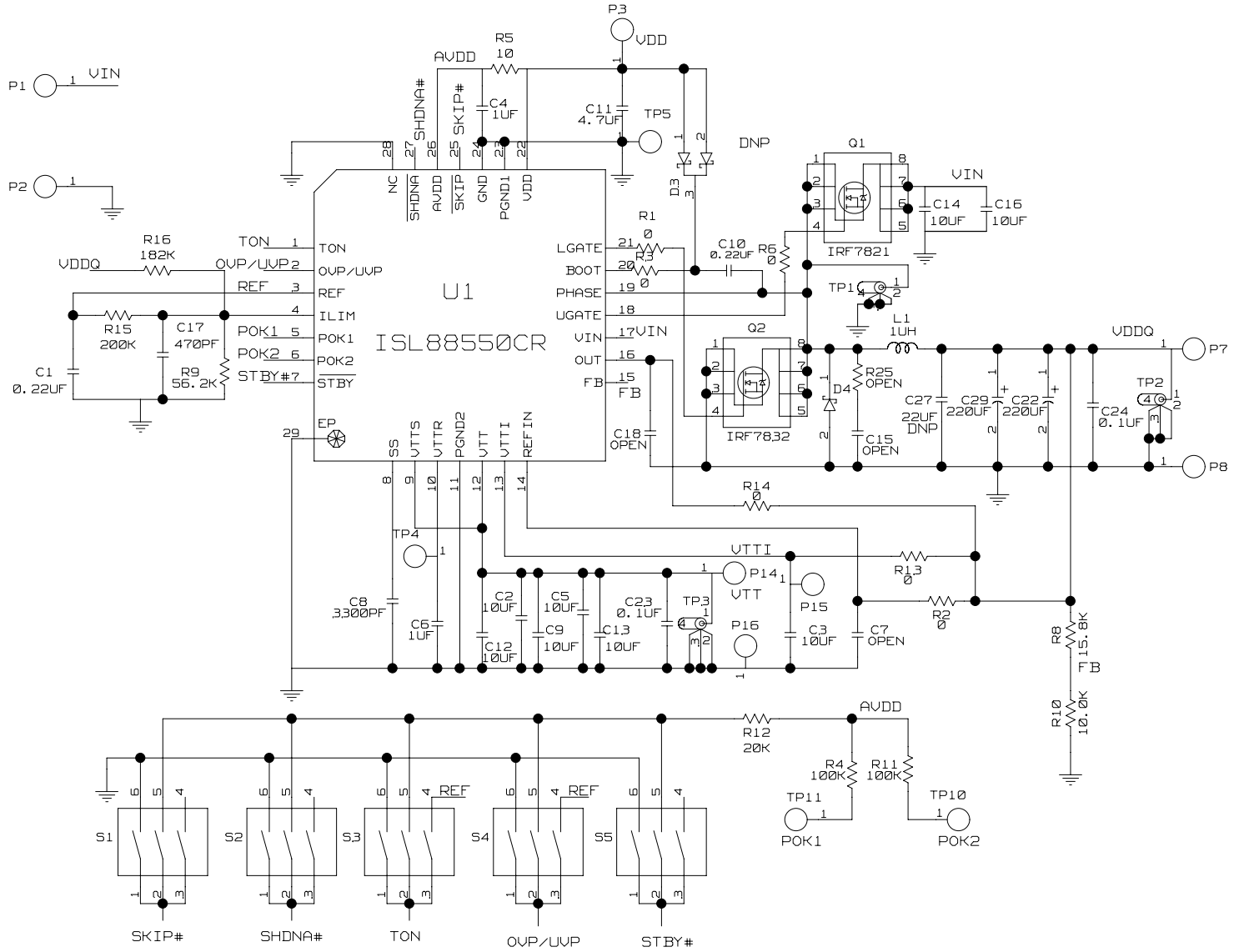

## Application Note 1200

**TABLE 6. COMPONENT LIST**

REF DES	QTY	VALUE	TOL.	VOLTAGE	PACKAGE	PART NUMBER	MANUFACTURER	DESCRIPTION
C1, C10	2	0.22 $\mu$ F	10%	50V	SM0805	-	AVX, Samsung, TDK, Murata	Multilayer Capacitor
C2, C3, C9	3	10 $\mu$ F	10%	>6.3V	SMD0805	-	AVX, Samsung, TDK, Murata	Multilayer Capacitor
C14, C16	2	10 $\mu$ F	10%	25V	SMD1812	-	AVX, Samsung, TDK, Murata	X5R Capacitor
C4, C6	2	1 $\mu$ F	10%	10V	SM0805	-	AVX, Samsung, TDK, Murata	Multilayer Capacitor
C11	1	4.7 $\mu$ F	10%	10V	SM0805	-	AVX, Samsung, TDK, Murata	Multilayer Capacitor
C27	0	OPEN	20%	10V	SMD1210	-	AVX, Samsung, TDK, Murata	C Series Capacitor (EIA:CC1210)
C29, C29	2	220 $\mu$ F	20%	4.0V	EIA_CASE_D	EEFUE0G221R	Panasonic	AL POLYMER
C17	1	470pF	10%	50V	SM0805	-	AVX, Samsung, TDK, Murata	Multilayer Capacitor
C24	1	0.1 $\mu$ F	10%	50V	SM0805	-	AVX, Samsung, TDK, Murata	Multilayer Capacitor
C5, C7, C8, C12, C13, C15, C18, C23	0	Open	10%	50V	SM0805/SM1206	-	AVX, Samsung, TDK, Murata	Multilayer Capacitor
D3	0	Open	-	30V	SOT23	BAT54WT1	On-Semi	30V Schottky Barrier Diode
D4	1	-	3A	40V	SMA	B340LA	Diodes-Inc	3A Low VF Schottky Barrier
L1	1	1.0 $\mu$ H	20%	2m $\Omega$	13_5x13_5	SD10L1 HM65-H1R0 C6125-1R0 FDA1254-1R0M	Falco BI Sumida Toko	Shielded SMD Inductor
Q1	1	-	11A	30V	SOIC8	IRF7821V	IR	30V 8.3A N-Power MOSFET
Q2	1	-	16A	30V	SOIC8	IRF7811AV	IR	30V 10.8A N-Power MOSFET
R1, R2, R3, R6, R13, R14	8	0	1%	150V	0805	-	Generic	Thick Film Chip Resistor
R12	1	20k	1%	150V	0805	-	Generic	Thick Film Chip Resistor
R9	1	56.2k	1%	150V	0805	-	Generic	Thick Film Chip Resistor
R4, R11	2	100k	1%	150V	0805	-	Generic	Thick Film Chip Resistor
R16	1	182k	1%	150V	0805	-	Generic	Thick Film Chip Resistor
R15	1	200k	1%	150V	0805	-	Generic	Thick Film Chip Resistor
R5, R25	0	Open	1%	150V	0805/1206	-	Generic	Thick Film Chip Resistor
R8	1	15.8k	1%	150V	0805	-	Generic	Thick Film Chip Resistor
R10	1	10k		150V	0805	-	Generic	Thick Film Chip Resistor
SW1-SW5	5	-	-	-	DIP06	DIP06-SW03	Grayhill	Dip Switch SPST
U1	1	-	-	-	TQFN	ISL88550A	Intersil	High Efficiency Output Rectifier Controller

ISL88550AEVAL1Z Board Layout

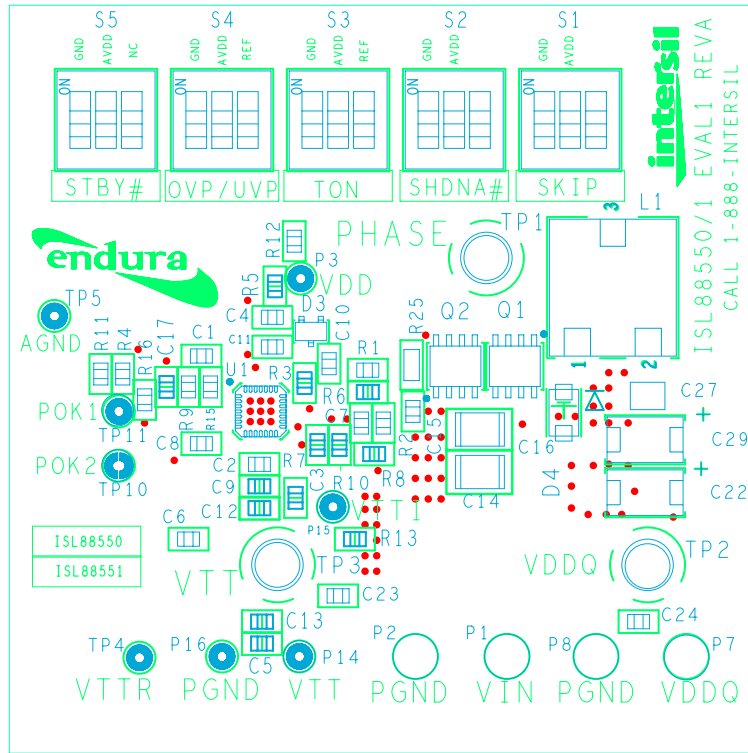

FIGURE 1. TOP COMPONENTS

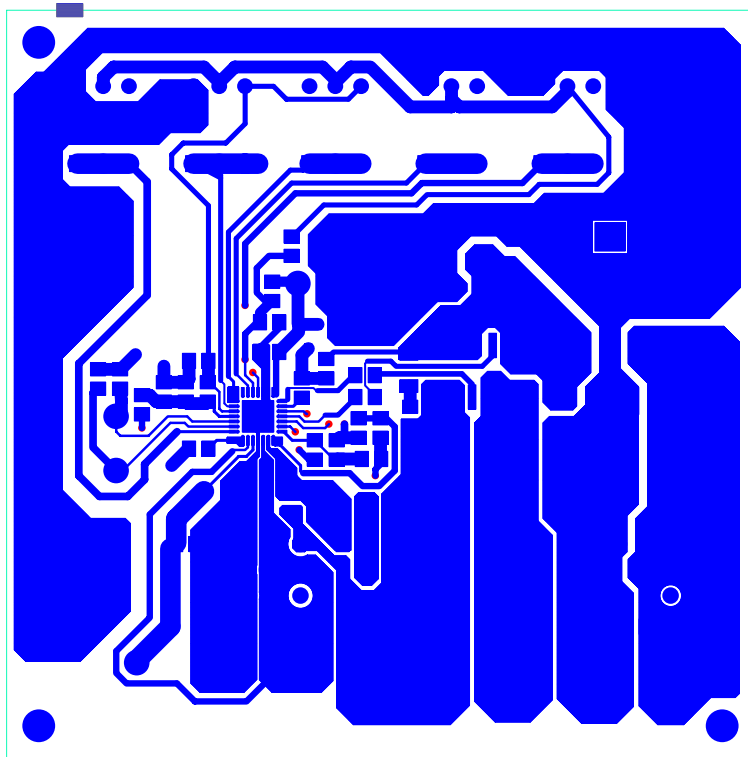

FIGURE 2. TOP LAYER ETCH

ISL88550AEVAL1Z Board Layout (Continued)

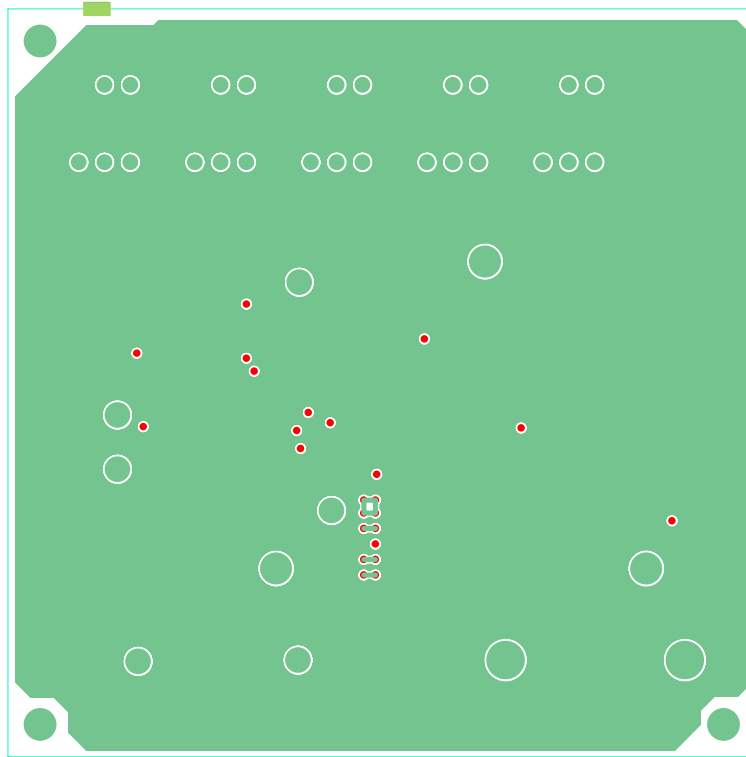

FIGURE 3. 2ND LAYER ETCH

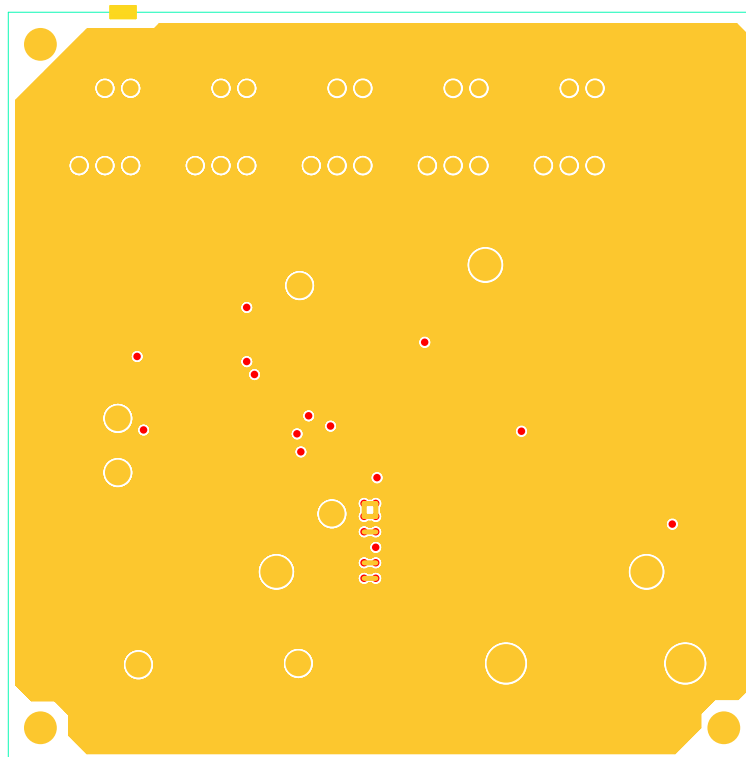

FIGURE 4. 3RD LAYER ETCH

ISL88550AEVAL1Z Board Layout (Continued)

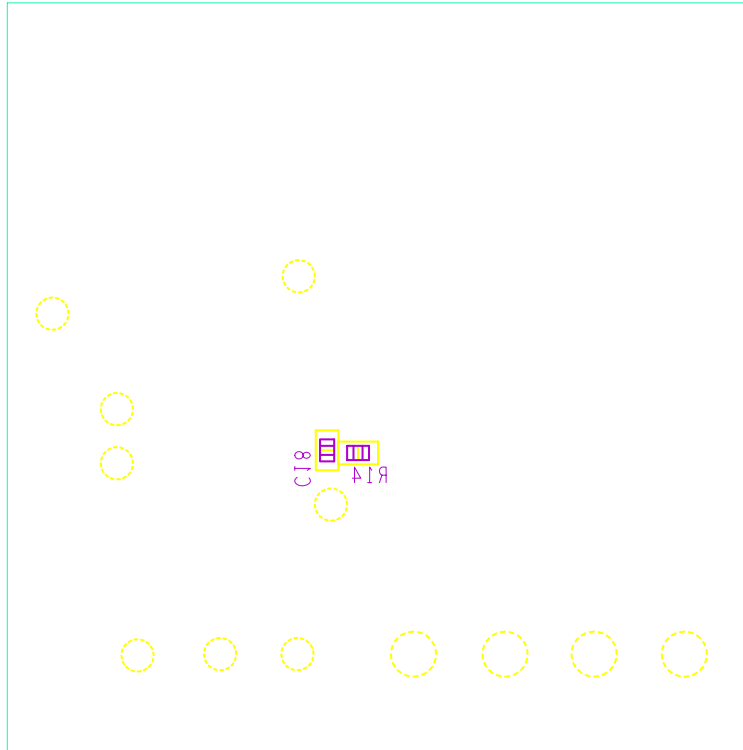

FIGURE 5. BOTTOM LAYER COMPONENTS (MIRRORED)

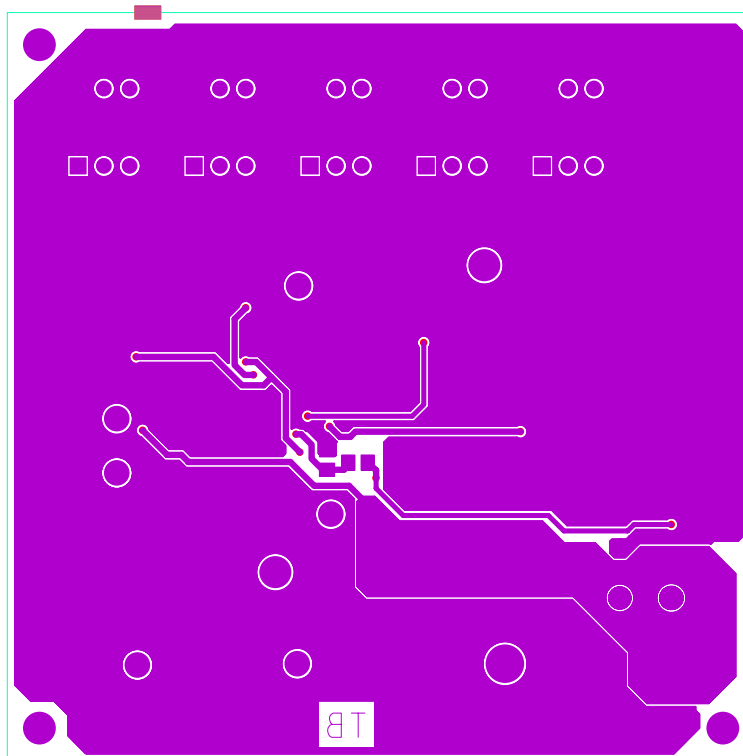

FIGURE 6. BOTTOM LAYER ETCH (MIRRORED)

Intersil Corporation reserves the right to make changes in circuit design, software and/or specifications at any time without notice. Accordingly, the reader is cautioned to verify that the Application Note or Technical Brief is current before proceeding.

For information regarding Intersil Corporation and its products, see [www.intersil.com](http://www.intersil.com)