

General-purpose CMOS Logic IC Series (BU4S,BU4000B Series)

Single Gate CMOS Logic ICs <Logic Gate>



BU4S01G2, BU4S11G2, BU4SU69G2,BU4S71G2, BU4S81G2, BU4S584G2

No.09050EAT01

● **Description**

The BU4SxxxG2 are 1ch logic ICs encapsulated in an SSOP5 package.
They are interchangeable with the general-purpose BU4000B series.

● **Features**

- 1) Low power consumption
- 2) Surface mount package (SSOP5)
- 3) Broad operating supply voltage range: 3V-16V
- 4) High input impedance
- 5) High fan out
- 6) L-TTL2 and LS-TTL1 inputs can be driven directly.
- 7) Function compatible with BU4000B series (1ch).

● **Applications**

Suitable for use where low power consumption and a high degree of noise tolerance are required.

● **Lineup**

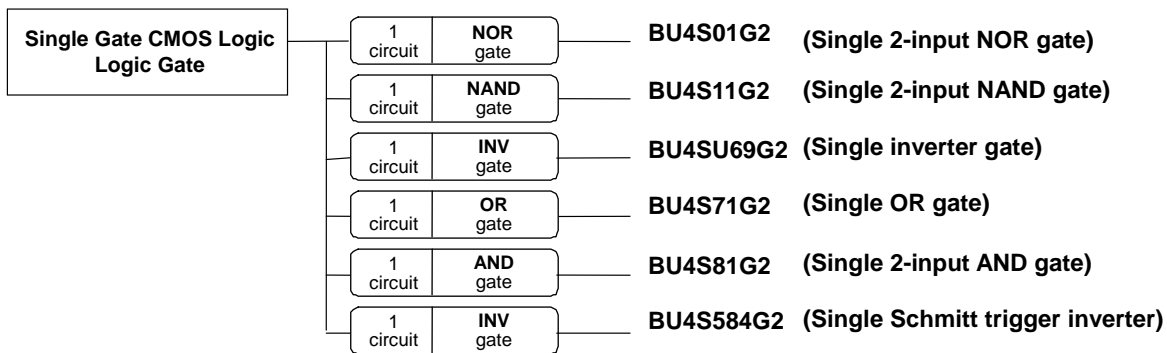

● Absolute Maximum Ratings

Parameter	Symbol	Limit					Unit
		BU4S01G2	BU4S11G2	BU4SU69G2	BU4S71G2	BU4S81G2	
Power supply voltage	VDD	-0.3 to 18					V
Supply current	Iin	±10					mA
Operating temperature	Topr	-40 to 85					°C
Storage temperature	Tstg	-55 to 150					°C
Input voltage	VIN	-0.3 to VDD+0.3					V
Maximum junction temperature	Tjmax	150					°C

● Recommended Operating Conditions

Parameter	Symbol	Limit					Unit
		BU4S01G2	BU4S11G2	BU4SU69G2	BU4S71G2	BU4S81G2	
Operating power supply	VDD	3 to 16					V
Input voltage	VIN	0 to VDD					V

● Thermal Derating Curve

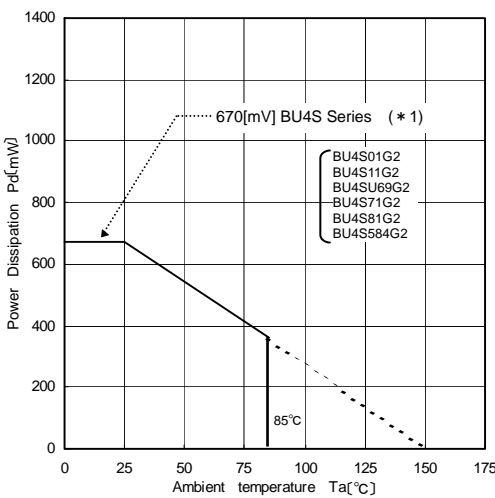

● Input / output Equivalent Circuits

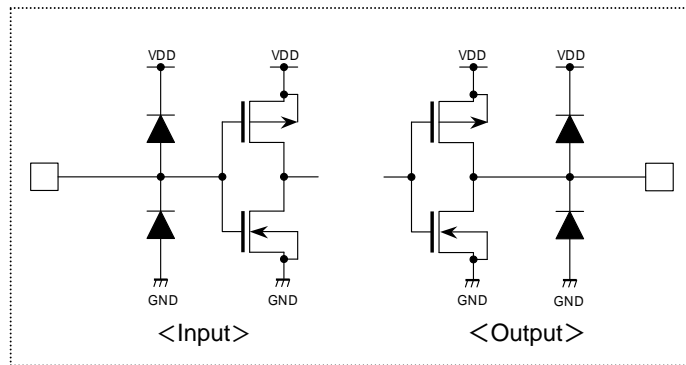

(*1)	UNIT
5.3	mW/°C

When used at Ta=25[°C] or above, values of above are reduced per 1[°C].
Power dissipation is the value for mounting 70[mm] x 70[mm] x 1.6[mm] FR4 glass epoxy circuit board (copper foil area is 3% or less).

● Switching Characteristics

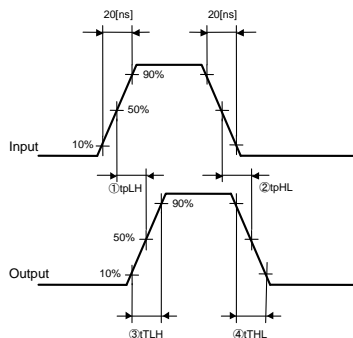
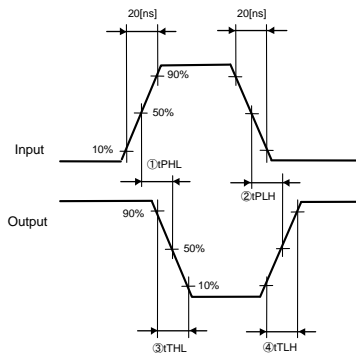

Description of symbols

- (1) tPHL: Time up to 50% of rise time of input waveform ~ 50% of fall time of output waveform
- (2) tPLH: Time up to 50% of fall time of input waveform ~ 50% of rise time of output waveform
- (3) tTHL: Time up to 90% ~ 10% of fall time of output waveform
- (4) tTLH: Time up to 10% ~ 90% of rise time of output waveform

Description of symbols

- (1) tPLH: Time up to 50% of rise time of input waveform ~ 50% of rise time of output waveform
- (2) tPHL: Time up to 50% of fall time of input waveform ~ 50% of fall time of output waveform
- (3) tTLH: Time up to 10% ~ 90% of rise time of output waveform
- (4) tTHL: Time up to 90% ~ 10% of fall time of output waveform

●Electrical Characteristics (BU4S01G2)

DC Characteristics (Unless otherwise noted, VSS=0[V], Ta=25[°C])

Parameter	Symbol	Standard Value			Unit	VDD[V]	Condition	Fig. No
		MIN	TYP	MAX				
Input "H" voltage	VIH	3.5	-	-	V	5	VOU=0.5[V] VOU=1.0[V] VOU=1.5[V] IOUT <1[μA]	1
		7.0	-	-		10		2
		11.0	-	-		15		3
Input "L" voltage	VIL	-	-	1.5	V	5	VOU=4.5[V] VOU=9.0[V] VOU=13.5[V] IOUT <1[μA]	1
		-	-	3.0		10		2
		-	-	4.0		15		3
Input "H" current	IIH	-	-	0.3	μA	15	VIH=15[V]	-
Input "L" current	IIL	-	-	-0.3	μA	15	VIL=0[V]	-
Output "H" voltage	VOH	4.95	-	-	V	5	IOUT <1[μA] VIN=VSS	4
		9.95	-	-		10		
		14.95	-	-		15		
Output "L" voltage	VOL	-	-	0.05	V	5	IOUT <1[μA] VIN=VDD	5
		-	-	0.05		10		
		-	-	0.05		15		
Output "H" current	IOH	-0.51	-	-	mA	5	VOH=4.6[V] VOH=2.5[V] VOH=9.5[V] VOH=13.5[V] VIN=VSS	4
		-2.1	-	-		5		
		-1.3	-	-		10		
		-3.4	-	-		15		
Output "L" current	IOL	0.51	-	-	mA	5	VOL=0.4[V] VOL=0.5[V] VOL=1.5[V] VIN=VDD	5
		1.3	-	-		10		
		3.4	-	-		15		
Static supply current	IDD	-	-	0.25	μA	5	VIN=VSS, VDD	-
		-	-	0.5		10		
		-	-	1.0		15		

Switching Characteristics (Unless otherwise noted, VSS=0[V], Ta=25[°C], CL=50[pF])

Parameter	Symbol	Standard Value			Unit	VDD[V]	Condition	Fig. No
		MIN	TYP	MAX				
Output rising time	tTLH	-	70	-	ns	5	-	6
		-	35	-		10		
		-	30	-		15		
Output falling time	tTHL	-	70	-	ns	5	-	7
		-	35	-		10		
		-	30	-		15		
Propagation delay time	tPLH	-	85	-	ns	5	-	8
		-	40	-		10		
		-	30	-		15		
	tPHL	-	85	-	ns	5	-	9
		-	40	-		10		
		-	30	-		15		
Input capacitance	CIN	-	5	-	pF	5	-	-

●Electrical Characteristics(BU4S11G2)

DC Characteristics (Unless otherwise noted, VSS=0[V], Ta=25[°C])

Parameter	Symbol	Standard Value			Unit	VDD[V]	Condition	Fig. No
		MIN	TYP	MAX				
Input "H" voltage	VIH	3.5	-	-	V	5	VOUT=0.5[V]	10
		7.0	-	-		10	VOUT=1.0[V]	11
		11.0	-	-		15	VOUT=1.5[V] IOUT <1[μA]	12
Input "L" voltage	VIL	-	-	1.5	V	5	VOUT=4.5[V]	10
		-	-	3.0		10	VOUT=9.0[V]	11
		-	-	4.0		15	VOUT=13.5[V] IOUT <1[μA]	12
Input "H" current	I _{IH}	-	-	0.3	μA	15	VIH=15[V]	-
Input "L" current	I _{IL}	-	-	-0.3	μA	15	VIL=0[V]	-
Output "H" voltage	VOH	4.95	-	-	V	5	IOUT <1[μA] VIN=VSS	13
		9.95	-	-		10		
		14.95	-	-		15		
Output "L" voltage	VOL	-	-	0.05	V	5	IOUT <1[μA] VIN=VDD	14
		-	-	0.05		10		
		-	-	0.05		15		
Output "H" current	IOH	-0.51	-	-	mA	5	VOH=4.6[V]	13
		-2.1	-	-		5	VOH=2.5[V]	
		-1.3	-	-		10	VOH=9.5[V]	
		-3.4	-	-		15	VOH=13.5[V] VIN=VSS	
Output "L" current	IOL	0.51	-	-	mA	5	VOL=0.4[V]	14
		1.3	-	-		10	VOL=0.5[V]	
		3.4	-	-		15	VOL=1.5[V] VIN=VDD	
Static supply current	IDD	-	-	0.25	μA	5	VIN=VSS,VDD	-
		-	-	0.5		10		
		-	-	1.0		15		

Switching Characteristics (Unless otherwise noted, VSS=0[V], Ta=25[°C], CL=50[pF])

Parameter	Symbol	Standard Value			Unit	VDD[V]	Condition	Fig. No
		MIN	TYP	MAX				
Output rising time	t _{TLH}	-	70	-	ns	5	-	15
		-	35	-		10		
		-	30	-		15		
Output falling time	t _{THL}	-	70	-	ns	5	-	16
		-	35	-		10		
		-	30	-		15		
Propagation delay time	t _{PLH}	-	85	-	ns	5	-	17
		-	40	-		10		
		-	30	-		15		
	t _{PHL}	-	85	-	ns	5	-	18
		-	40	-		10		
		-	30	-		15		
Input capacitance	C _{IN}	-	5	-	pF	5	-	-

●Electrical Characteristics(BU4SU69G2)

DC Characteristics (Unless otherwise noted, VSS=0[V], Ta=25[°C])

Parameter	Symbol	Standard Value			Unit	VDD[V]	Condition	Fig. No
		MIN	TYP	MAX				
Input "H" voltage	VIH	4.0	-	-	V	5	VOUT=0.5[V] VOUT=1.0[V] VOUT=1.5[V] IOUT <1[μA]	19
		8.0	-	-		10		20
		12.0	-	-		15		21
Input "L" voltage	VIL	-	-	1.0	V	5	VOUT=4.5[V] VOUT=9.0[V] VOUT=13.5[V] IOUT <1[μA]	19
		-	-	2.0		10		20
		-	-	3.0		15		21
Input "H" current	IIH	-	-	0.3	μA	15	VIH=15[V]	-
Input "L" current	IIL	-	-	-0.3	μA	15	VIL=0[V]	-
Output "H" voltage	VOH	4.95	-	-	V	5	IOUT <1[μA] VIN=VSS	22
		9.95	-	-		10		
		14.95	-	-		15		
Output "L" voltage	VOL	-	-	0.05	V	5	IOUT <1[μA] VIN=VDD	23
		-	-	0.05		10		
		-	-	0.05		15		
Output "H" current	IOH	-0.51	-	-	mA	5	VOH=4.6[V] VOH=2.5[V] VOH=9.5[V] VOH=13.5[V] VIN=VSS	22
		-2.1	-	-		5		
		-1.3	-	-		10		
		-3.4	-	-		15		
Output "L" current	IOL	0.51	-	-	mA	5	VOL=0.4[V] VOL=0.5[V] VOL=1.5[V] VIN=VDD	23
		1.3	-	-		10		
		3.4	-	-		15		
Static supply current	IDD	-	-	0.25	μA	5	VIN=VSS,VDD	-
		-	-	0.5		10		
		-	-	1.0		15		

Switching Characteristics (Unless otherwise noted, VSS=0[V], Ta=25[°C], CL=50[pF])

Parameter	Symbol	Standard Value			Unit	VDD[V]	Condition	Fig. No
		MIN	TYP	MAX				
Output rising time	tTLH	-	70	-	ns	5	-	24
		-	35	-		10		
		-	30	-		15		
Output falling time	tTHL	-	70	-	ns	5	-	25
		-	35	-		10		
		-	30	-		15		
Propagation delay time	tPLH	-	55	-	ns	5	-	26
		-	30	-		10		
		-	25	-		15		
	tPHL	-	55	-	ns	5	-	27
		-	30	-		10		
		-	25	-		15		
Input capacitance	CIN	-	5	-	pF	5	-	-

●Electrical Characteristics(BU4S71G2)

DC Characteristics (Unless otherwise noted, VSS=0[V], Ta=25[°C])

Parameter	Symbol	Standard Value			Unit	VDD[V]	Condition	Fig. No
		MIN	TYP	MAX				
Input "H" voltage	VIH	3.5	-	-	V	5	IOUT <1[μA]	28
		7.0	-	-		10		29
		11.0	-	-		15		30
Input "L" voltage	VIL	-	-	1.5	V	5	IOUT <1[μA]	28
		-	-	3.0		10		29
		-	-	4.0		15		30
Input "H" current	IIH	-	-	0.3	μA	18	VIH=18[V]	-
Input "L" current	IIL	-	-	-0.3	μA	18	VIL=0[V]	-
Output "H" voltage	VOH	4.95	-	-	V	5	IOUT <1[μA] VIN=VSS or VDD	31
		9.95	-	-		10		
		14.95	-	-		15		
Output "L" voltage	VOL	-	-	0.05	V	5	IOUT <1[μA] VIN=VSS	32
		-	-	0.05		10		
		-	-	0.05		15		
Output "H" current	IOH	-0.51	-	-	mA	5	VOH=4.6[V]	31
		-2.1	-	-		5	VOH=2.5[V]	
		-1.3	-	-		10	VOH=9.5[V]	
		-3.4	-	-		15	VOH=13.5[V]	
Output "L" current	IOL	0.51	-	-	mA	5	VOL=0.4[V]	32
		1.3	-	-		10	VOL=0.5[V]	
		3.4	-	-		15	VOL=1.5[V]	
Static supply current	IDD	-	-	0.25	μA	5	VIN=VSS,VDD	-
		-	-	0.5		10		
		-	-	1.0		15		

Switching Characteristics (Unless otherwise noted, VSS=0[V], Ta=25[°C], CL=50[pF])

Parameter	Symbol	Standard Value			Unit	VDD[V]	Condition	Fig. No
		MIN	TYP	MAX				
Output rising time	tTLH	-	70	-	ns	5	-	33
		-	35	-		10		
		-	30	-		15		
Output falling time	tTHL	-	70	-	ns	5	-	34
		-	35	-		10		
		-	30	-		15		
Propagation delay time	tPLH	-	90	-	ns	5	-	35
		-	45	-		10		
		-	30	-		15		
	tPHL	-	90	-	ns	5	-	36
		-	45	-		10		
		-	30	-		15		
Input capacitance	CIN	-	5	-	pF	5	-	-

●Electrical Characteristics(BU4S81G2)

DC Characteristics (Unless otherwise noted, VSS=0[V], Ta=25[°C])

Parameter	Symbol	Standard Value			Unit	VDD[V]	Condition	Fig. No
		MIN	TYP	MAX				
Input "H" voltage	VIH	3.5	-	-	V	5	IOUT <1[μA]	37
		7.0	-	-		10		38
		11.0	-	-		15		39
Input "L" voltage	VIL	-	-	1.5	V	5	IOUT <1[μA]	37
		-	-	3.0		10		38
		-	-	4.0		15		39
Input "H" current	I _{IH}	-	-	0.3	μA	18	V _{IH} =18[V]	-
Input "L" current	I _{IL}	-	-	-0.3	μA	18	V _{IL} =0[V]	-
Output "H" voltage	V _{OH}	4.95	-	-	V	5	I _O UT <1[μA] V _{IN} =V _{SS} or V _{DD}	40
		9.95	-	-		10		
		14.95	-	-		15		
Output "L" voltage	V _{OL}	-	-	0.05	V	5	I _O UT <1[μA] V _{IN} =V _{SS}	41
		-	-	0.05		10		
		-	-	0.05		15		
Output "H" current	I _{OH}	-0.51	-	-	mA	5	V _{OH} =4.6[V]	40
		-2.1	-	-		5	V _{OH} =2.5[V]	
		-1.3	-	-		10	V _{OH} =9.5[V]	
		-3.4	-	-		15	V _{OH} =13.5[V]	
Output "L" current	I _{OL}	0.51	-	-	mA	5	V _{OL} =0.4[V]	41
		1.3	-	-		10	V _{OL} =0.5[V]	
		3.4	-	-		15	V _{OL} =1.5[V]	
Static supply current	I _{DD}	-	-	0.25	μA	5	V _{IN} =V _{SS} , V _{DD}	-
		-	-	0.5		10		
		-	-	1.0		15		

Switching Characteristics (Unless otherwise noted, VSS=0[V], Ta=25[°C], CL=50[pF])

Parameter	Symbol	Standard Value			Unit	VDD[V]	Condition	Fig. No
		MIN	TYP	MAX				
Output rising time	t _{TLH}	-	70	-	ns	5	-	42
		-	35	-		10		
		-	30	-		15		
Output falling time	t _{THL}	-	70	-	ns	5	-	43
		-	35	-		10		
		-	30	-		15		
Propagation delay time	t _{PLH}	-	90	-	ns	5	-	44
		-	45	-		10		
		-	30	-		15		
	t _{PHL}	-	90	-	ns	5	-	45
		-	45	-		10		
		-	30	-		15		
Input capacitance	C _{IN}	-	5	-	pF	5	-	-

●Electrical Characteristics(BU4S584G2)

DC Characteristics (Unless otherwise noted, VSS=0[V], Ta=25[°C])

Parameter	Symbol	Standard Value			Unit	VDD[V]	Condition	Fig. No
		MIN	TYP	MAX				
Input "H" voltage	VIH	2.6	-	-	V	3	-	46
		3.5	-	-		5		47
		7.0	-	-		10		48
		11.0	-	-		15		
Input "L" voltage	VIL	-	-	0.4	V	3	-	46
		-	-	1.5		5		47
		-	-	3.0		10		48
		-	-	4.0		15		
Input "H" current	I _{IH}	-	-	0.3	μA	15	VIH=15[V]	-
Input "L" current	I _{IL}	-	-	-0.3	μA	15	VIL=0[V]	-
Output "H" voltage	VOH	2.95	-	-	V	3	I _O T <1[μA] VIN=VSS	49
		4.95	-	-		5		
		9.95	-	-		10		
		14.95	-	-		15		
Output "L" voltage	VOL	-	-	0.05	V	3	I _O T <1[μA] VIN=VDD	50
		-	-	0.05		5		
		-	-	0.05		10		
		-	-	0.05		15		
Output "H" current	IOH	-0.1	-	-	mA	3	VOH=2.7[V]	49
		-0.51	-	-		5	VOH=4.6 [V]	
		-2.1	-	-		5	VOH=2.5[V]	
		-1.3	-	-		10	VOH=9.5[V]	
		-3.4	-	-		15	VOH=13.5[V]	
Output "L" current	IOL	0.1	-	-	mA	3	VOL=0.3[V]	50
		0.51	-	-		5	VOL=0.4[V]	
		1.3	-	-		10	VOL=0.5[V]	
		3.4	-	-		15	VOL=1.5[V]	
		0.1	-	0.5		V	3	
0.15	-	0.6	5					
0.25	-	1.0	10					
0.40	-	1.5	15					
Supply current	IDD	-	-	0.2	μA	3	VIN=VSS or VDD	-
		-	-	0.25		5		
		-	-	0.5		10		
		-	-	1.0		15		
		-	-	1.0		15		

Switching Characteristics (Unless otherwise noted, VSS=0[V], Ta=25[°C], CL=50[pF])

Parameter	Symbol	Standard Value			Unit	VDD[V]	Condition	Fig. No	
		MIN	TYP	MAX					
Output rising time	t _{TLH}	-	140	-	ns	3	-	51	
		-	70	-		5			
		-	35	-		10			
		-	30	-		15			
Output falling time	t _{THL}	-	140	-	ns	3	-	52	
		-	70	-		5			
		-	35	-		10			
		-	30	-		15			
Propagation delay time	t _{PLH}	-	230	-	ns	3	-	53	
		-	125	-		5			
		-	60	-		10			
		-	50	-		15			
	t _{PHL}	t _{PHL}	-	230	-	ns	3	-	54
			-	125	-		5		
			-	60	-		10		
			-	50	-		15		

●Electrical Characteristics Curves(BU4S01G2)

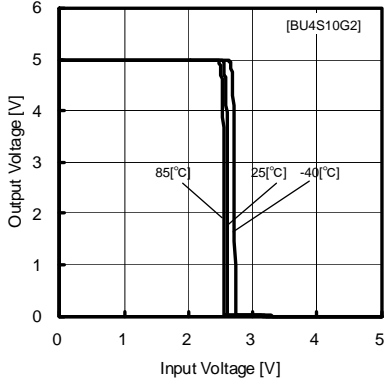

Fig.1

Output voltage - Input voltage characteristics (VDD=5[V] / VSS=0[V])

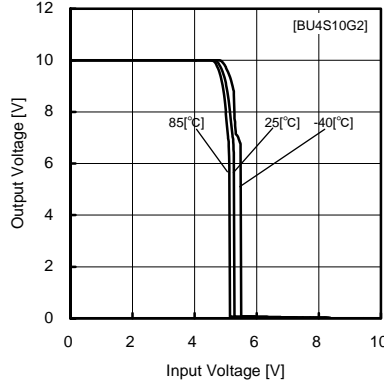

Fig.2

Output voltage - Input voltage characteristics (VDD=10[V] / VSS=0[V])

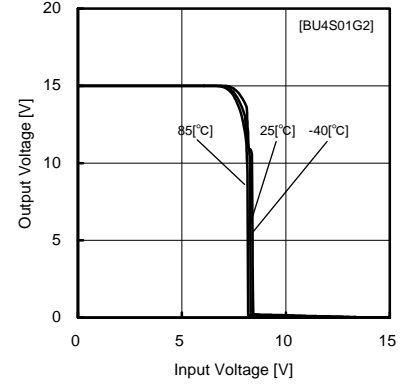

Fig.3

Output voltage - Input voltage characteristics (VDD=15[V] / VSS=0[V])

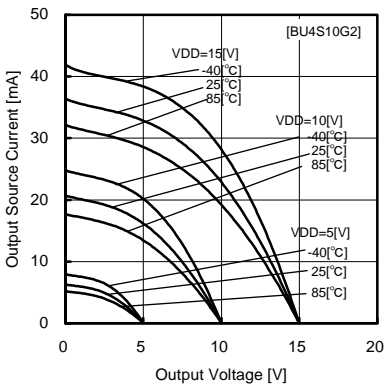

Fig.4

Output source current - voltage characteristics

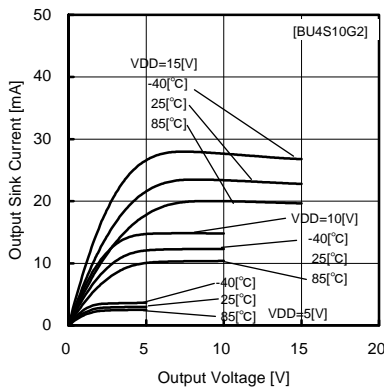

Fig.5

Output sink current - voltage characteristics

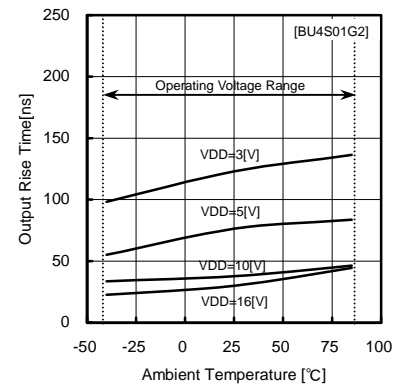

Fig.6

Output rising time tTLH

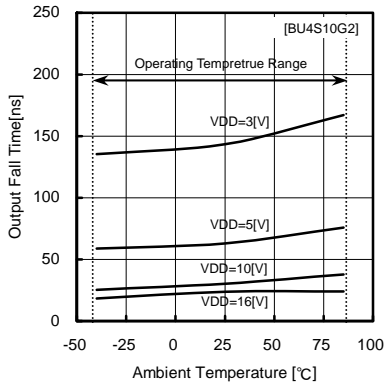

Fig.7

Output falling time tTHL

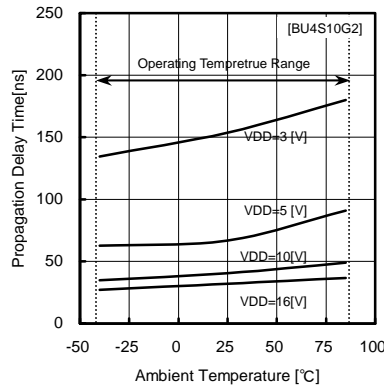

Fig.8

Propagation delay time tPLH

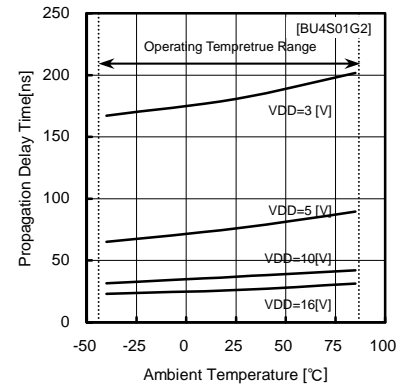
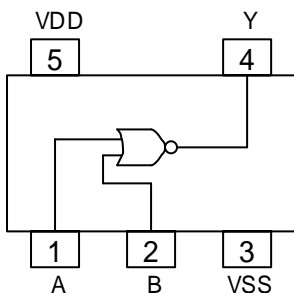

Fig.9

Propagation delay time tPHL

●Pinout Diagram · Pin Description · Input / Output Table



PIN	PIN NAME	I/O	PIN FUNCTION
1	A	I	Input
2	B	I	Input
3	VSS	-	Power supply(-)
4	Y	O	Output
5	VDD	-	Power supply(+)

A	B	Y
L	L	H
L	H	L
H	L	L
H	H	L

●Electrical Characteristics Curves(BU4S11G2)

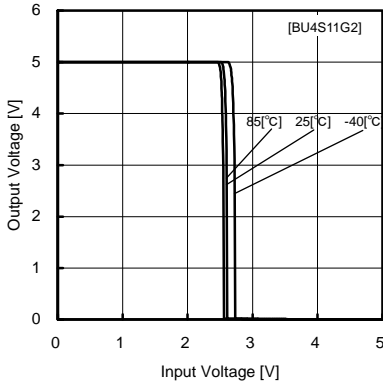

Fig.10 Output voltage—Input voltage characteristics (VDD=5[V] / VSS=0[V])

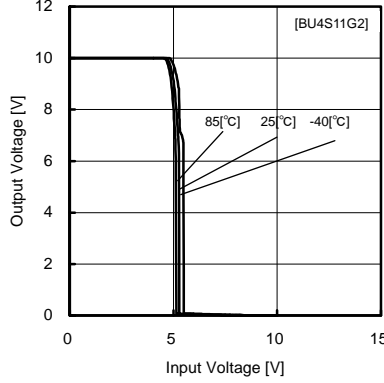

Fig.11 Output voltage—Input voltage characteristics (VDD=10[V] / VSS=0[V])

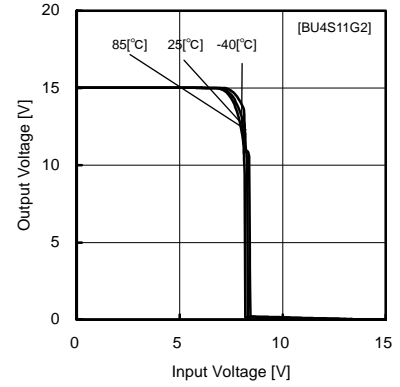

Fig.12 Output voltage—Input voltage characteristics (VDD=15[V] / VSS=0[V])

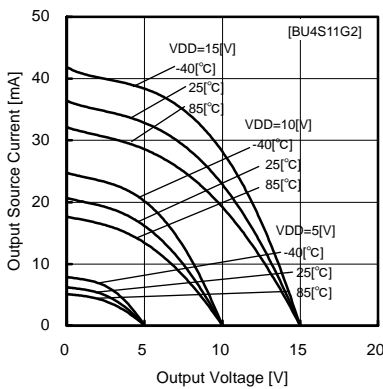

Fig.13 Output source current—voltage characteristics

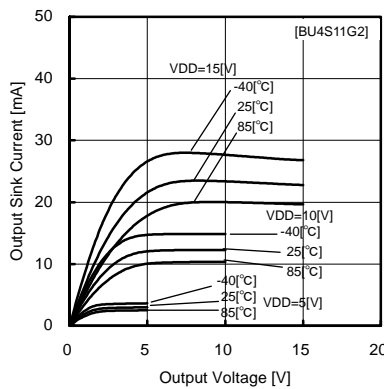

Fig.14 Output sink current—voltage characteristics

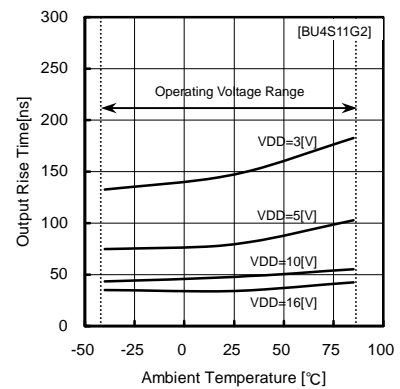

Fig.15 Output rising time tTLH

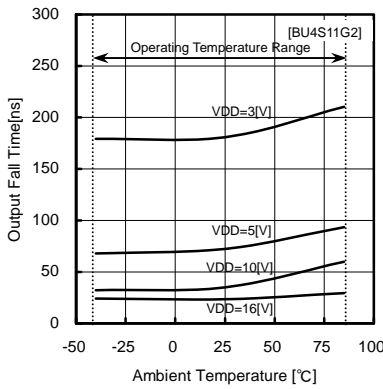

Fig.16 Output falling time tTHL

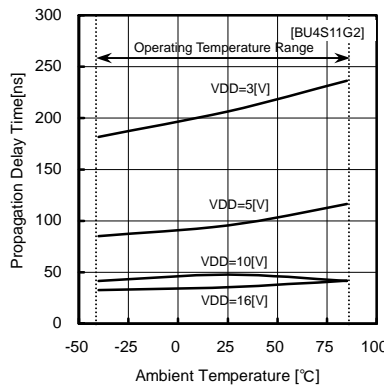

Fig.17 Propagation delay time tPLH

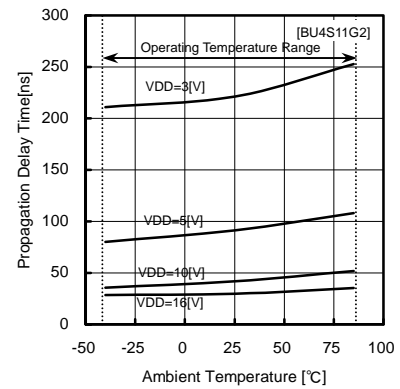
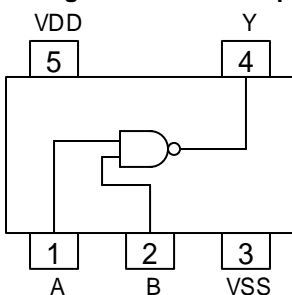

Fig.18 Propagation delay time tPHL

●Pinout Diagram · Pin Description · Input / Output Table



PIN	PIN NAME	I/O	PIN FUNCTION
1	A	I	Input
2	B	I	Input
3	VSS	-	Power supply(-)
4	Y	O	Output
5	VDD	-	Power supply(+)

A	B	Y
L	L	H
L	H	H
H	L	H
H	H	L

● Electrical Characteristics Curves (BU4SU69G2)

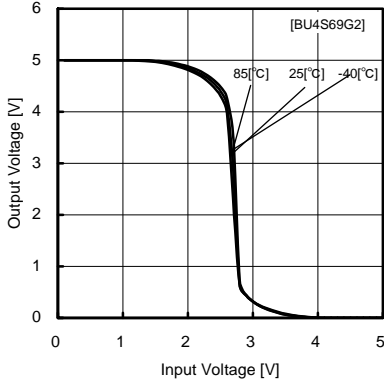

Fig.19

Output voltage - Input voltage characteristics (VDD=5[V] / VSS=0[V])

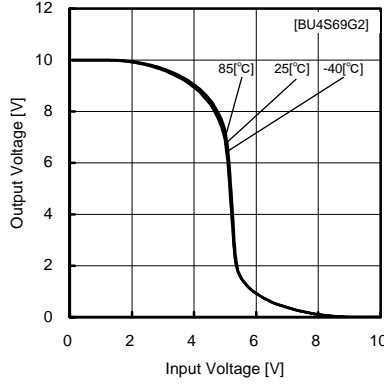

Fig.20

Output voltage - Input voltage characteristics (VDD=10[V] / VSS=0[V])

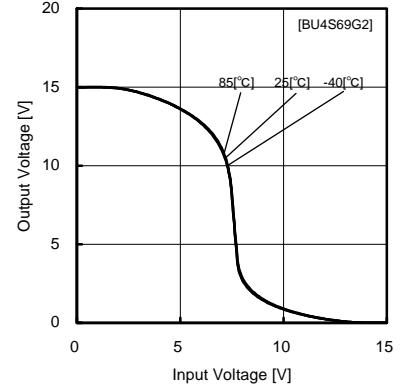

Fig.21

Output voltage - Input voltage characteristics (VDD=15[V] / VSS=0[V])

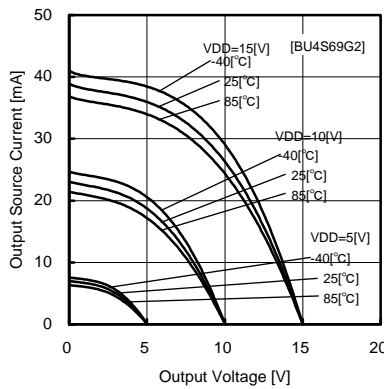

Fig.22

Output source current - voltage characteristics

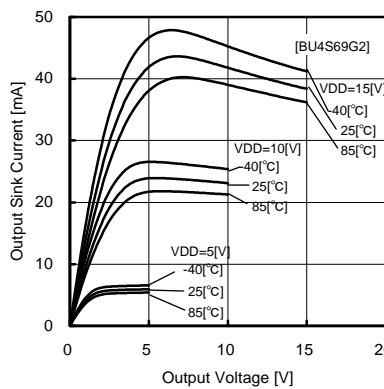

Fig.23

Output sink current - voltage characteristics

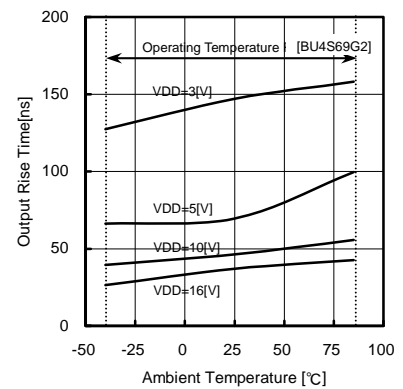

Fig.24

Output rising time tRLH

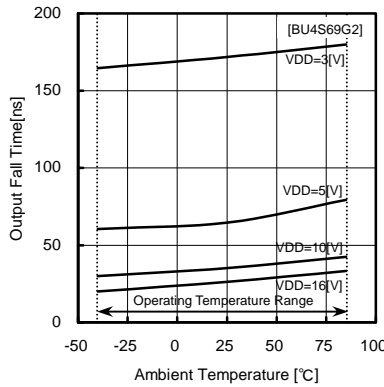

Fig.25

Output falling time tFHL

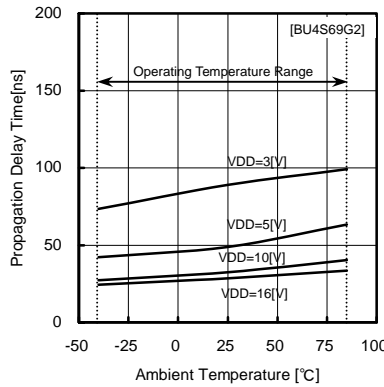

Fig.26

Propagation delay time tPLH

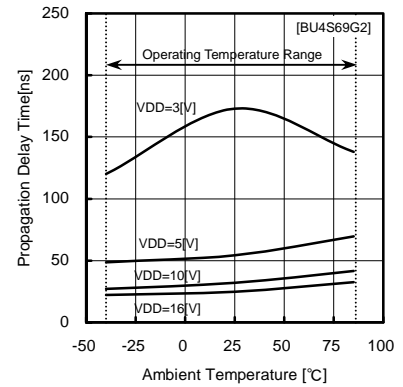
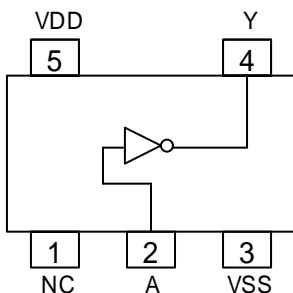

Fig.27

Propagation delay time tPHL

● Pinout Diagram · Pin Description · Input / Output Table



PIN	PIN NAME	I/O	PIN FUNCTION
1	NC	-	NC
2	A	I	Input
3	VSS	-	Power supply(-)
4	Y	O	Output
5	VDD	-	Power supply(+)

A	Y
L	H
H	L

●Electrical Characteristics Curves (BU4S71G2)

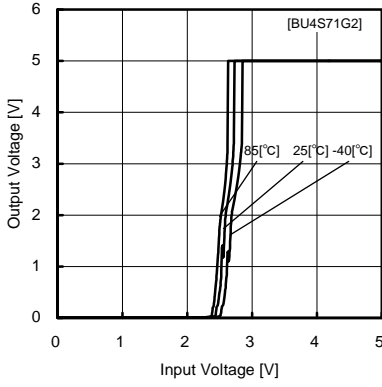

Fig.28

Output voltage—Input voltage characteristics (VDD=5[V]/ VSS=0[V])

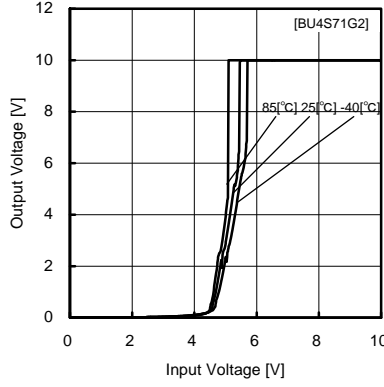

Fig.29

Output voltage—Input voltage characteristics (VDD=10[V] / VSS=0[V])

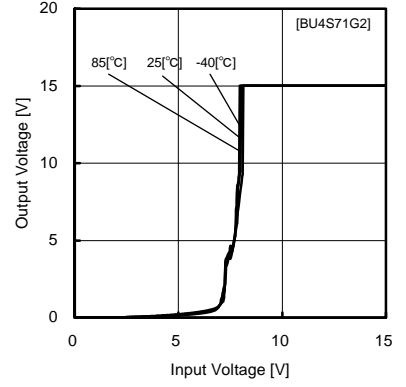

Fig.30

Output voltage—Input voltage characteristics (VDD=15[V] / VSS=0[V])

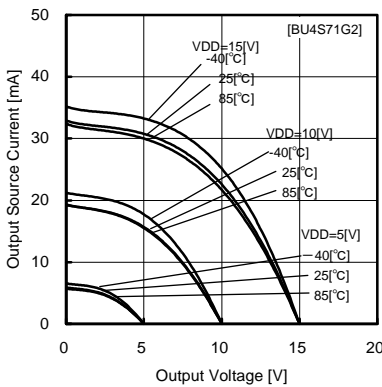

Fig.31

Output source current—voltage characteristics

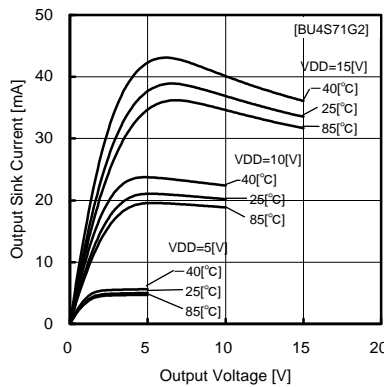

Fig.32

Output sink current—voltage characteristics

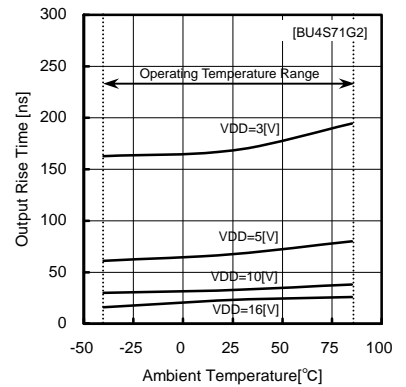

Fig.33

Rising time tTLH

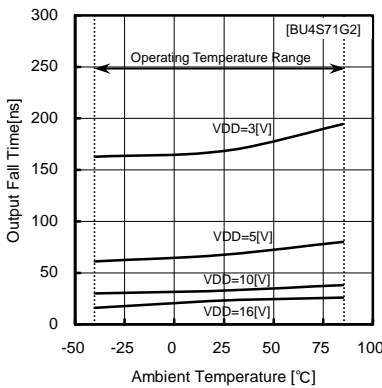

Fig.34

falling time tTHL

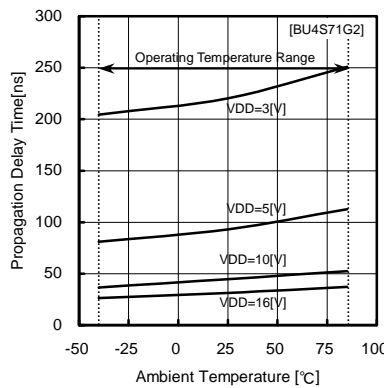

Fig.35

Propagation delay time tPLH

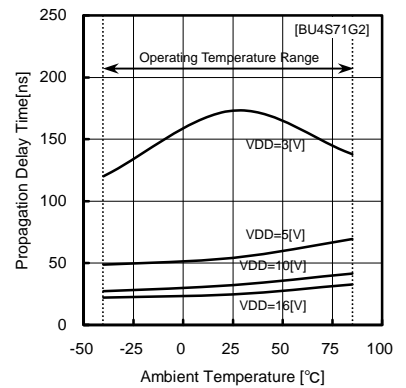
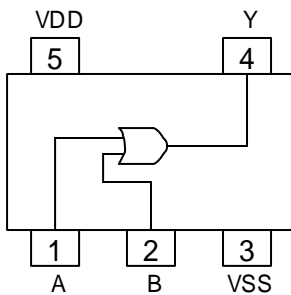

Fig.36

Propagation delay time tPHL

●Pinout Diagram • Pin Description • Input / Output Table



PIN	PIN NAME	I/O	PIN FUNCTION
1	A	I	Input
2	B	I	Input
3	VSS	-	Power supply(-)
4	Y	O	Output
5	VDD	-	Power supply(+)

A	B	Y
L	L	L
L	H	H
H	L	H
H	H	H

●Electrical Characteristics Curves(BU4S81G2)

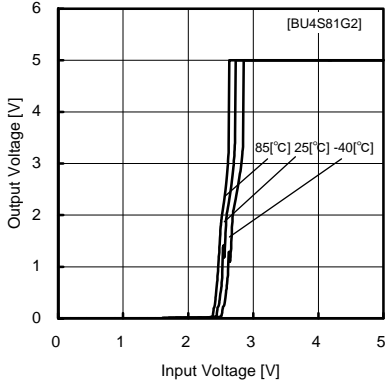

Fig.37

Output voltage—Input voltage characteristics (VDD=5[V] / VSS=0[V])

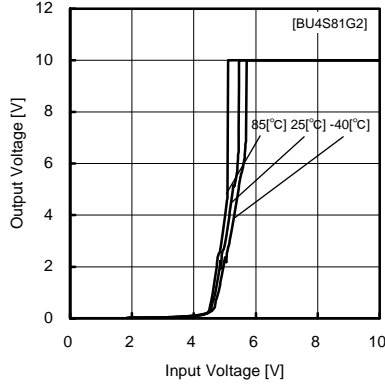

Fig.38

Output voltage—Input voltage characteristics (VDD=10[V] / VSS=0[V])

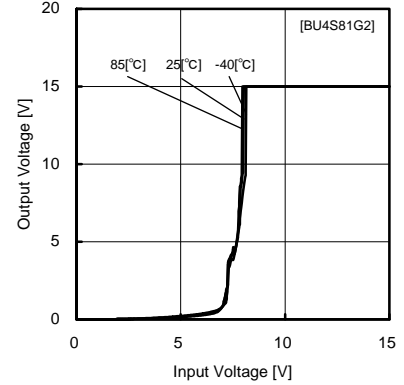

Fig.39

Output voltage—Input voltage characteristics (VDD=15[V] / VSS=0[V])

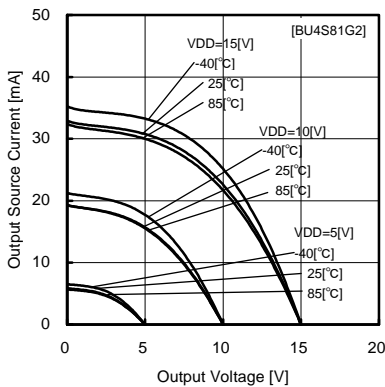

Fig.40

Output source current—voltage characteristics

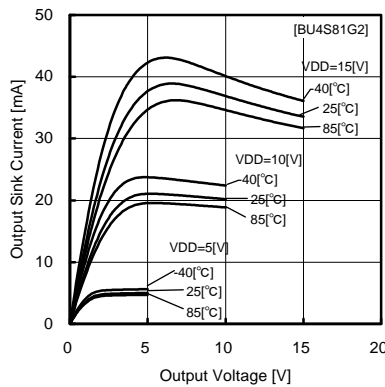

Fig.41

Output sink current—voltage characteristics

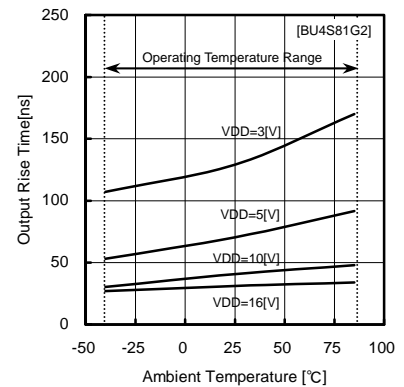

Fig.42

Output rising time tLH

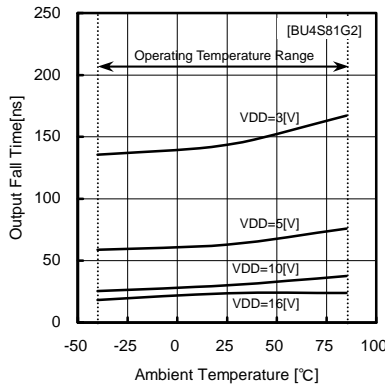

Fig.43

Output falling time tHL

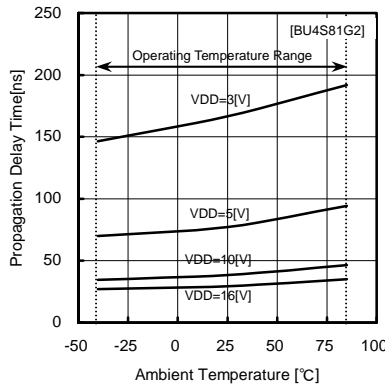

Fig.44

Propagation delay time tPLH

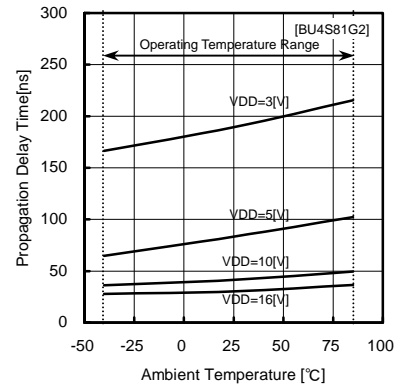
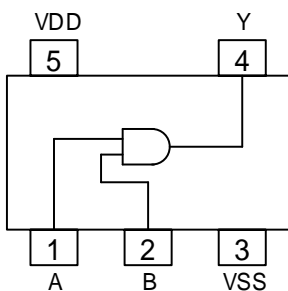

Fig.45

Propagation delay time tPHL

●Pinout Diagram · Pin Description · Input / Output Table



PIN	PIN NAME	I/O	PIN FUNCTION
1	NC	-	Input
2	A	I	Input
3	VSS	-	Power supply(-)
4	Y	O	Output
5	VDD	-	Power supply(+)

A	B	Y
L	L	L
L	H	L
H	L	L
H	H	H

●Electrical Characteristics Curves(BU4S584G2)

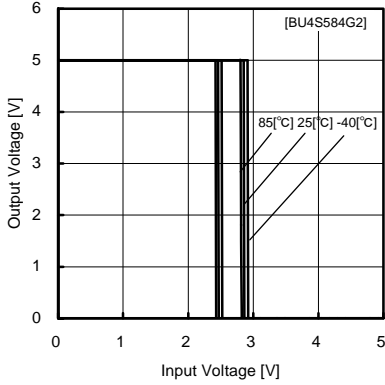

Fig.46

Output voltage—Input voltage characteristics (VDD=5[V] / VSS=0[V])

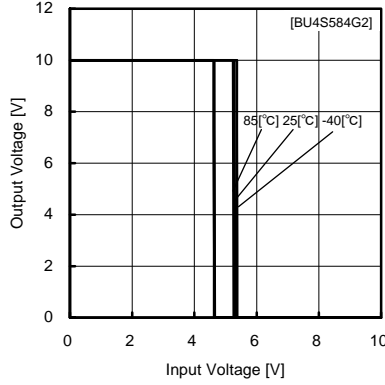

Fig.47

Output voltage—Input voltage characteristics (VDD=10[V] / VSS=0[V])

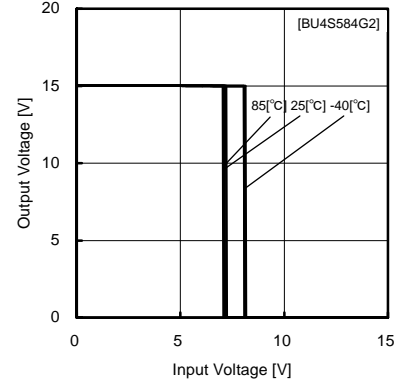

Fig.48

Output voltage—Input voltage characteristics (VDD=15[V] / VSS=0[V])

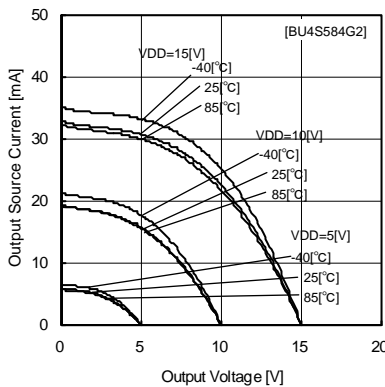

Fig.49

Output source current—voltage characteristics

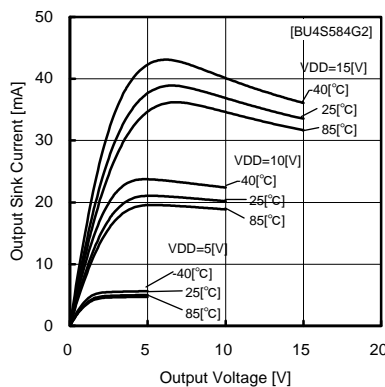

Fig.50

Output sink current—voltage characteristics

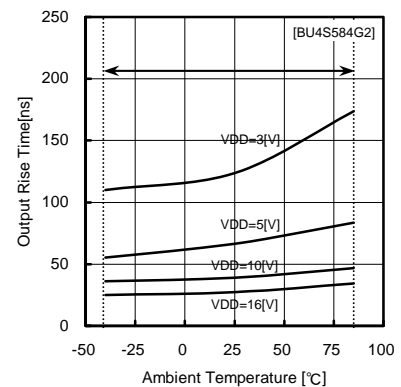

Fig.51

Output rising time tTLH

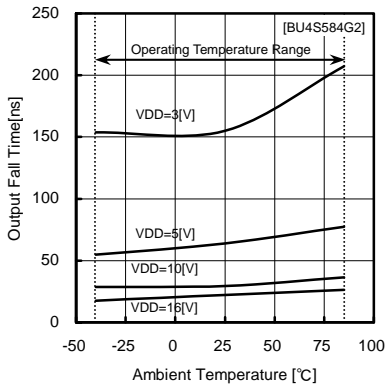

Fig.52

Output falling time tTHL

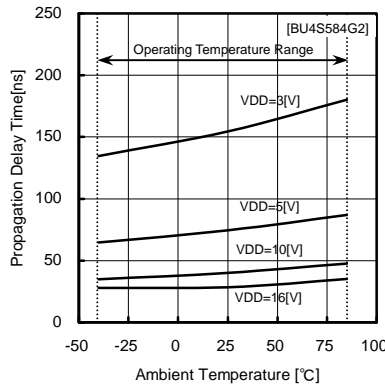

Fig.53

Propagation delay time tPLH

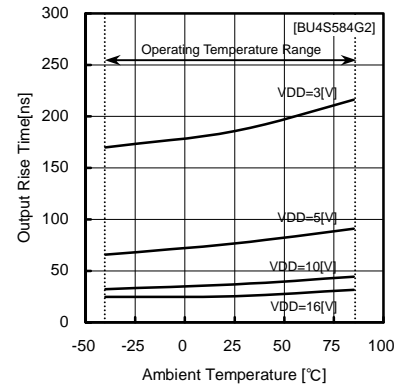
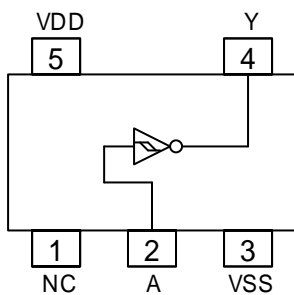

Fig.54

Propagation delay time tPHL

●Pinout Diagram · Pin Description · Input / Output Table



PIN	PIN NAME	I/O	PIN FUNCTION
1	NC	-	NC
2	A	I	Input
3	VSS	-	Power supply(-)
4	Y	O	Output
5	VDD	-	Power supply(+)

A	Y
L	H
H	L

●Notes for use**1. Absolute Maximum ratings**

An excess in the absolute maximum ratings, such as supply voltage, temperature range of operating conditions, etc., can break down the devices, thus making impossible to identify breaking mode, such as short circuit or an open circuit. If any over rated values will expect to exceed the absolute maximum ratings, consider adding circuit protection devices, such as fuses.

2. Connecting the power supply connector backward

Connecting of the power supply in reverse polarity can damage IC. Take precautions when connecting the power supply lines. An external direction diode can be added.

3. Power supply lines

Design PCB layout pattern to provide low impedance GND and supply lines. To obtain a low noise ground and supply line, separate the ground section and supply lines of the digital and analog blocks. Furthermore, for all power supply terminals to ICs, connect a capacitor between the power supply and the GND terminal. When applying electrolytic capacitors in the circuit, not that capacitance characteristic values are reduced at low temperatures.

4. GND voltage

The potential of GND pin must be minimum potential in all operating conditions.

5. Thermal design

Use a thermal design that allows for a sufficient margin in light of the power dissipation (Pd) in actual operating conditions.

6. Inter-pin shorts and mounting errors

Use caution when positioning the IC for mounting on printed circuit boards. The IC may be damaged if there is any connection error or if pins are shorted together.

7. Actions in strong electromagnetic field

Use caution when using the IC in the presence of a strong electromagnetic field as doing so may cause the IC to malfunction.

8. Testing on application boards

When testing the IC on an application board, connecting a capacitor to a pin with low impedance subjects the IC to stress. Always discharge capacitors after each process or step. Always turn the IC's power supply off before connecting it to or removing it from a jig or fixture during the inspection process. Ground the IC during assembly steps as an antistatic measure. Use similar precaution when transporting or storing the IC.

9. Ground Wiring Pattern

When using both small signal and large current GND patterns, it is recommended to isolate the two ground patterns, placing a signal ground point at the ground potential of application so that the pattern wiring resistance and voltage variations caused by large currents do not cause variations in the small signal ground voltage. Be careful not to change the GND wiring pattern of any external components, either.

10. Unused input terminals

Connect all unused input terminals to VDD or VSS in order to prevent excessive current or oscillation. Insertion of a resistor (100kΩ approx.) is also recommended.

● Ordering part number

B	U	4	S	0	1	G	2	-	T	R
Part No.		Part No. 4S01, 4S11 4SU69, 4S71 4S81, 4S584				Package G2: SSOP5		Packaging and forming specification TR: Embossed tape and reel		

SSOP5

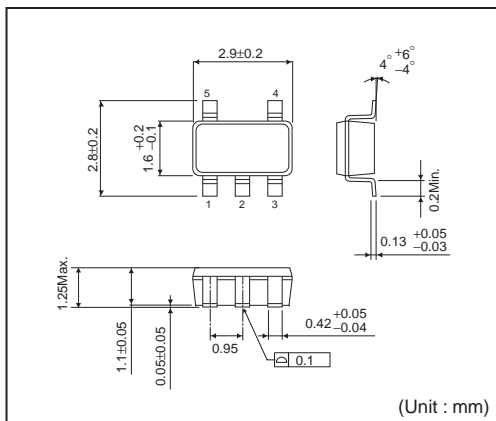

<Tape and Reel information>

Tape	Embossed carrier tape
Quantity	3000pcs
Direction of feed	TR (The direction is the 1pin of product is at the upper right when you hold reel on the left hand and you pull out the tape on the right hand)

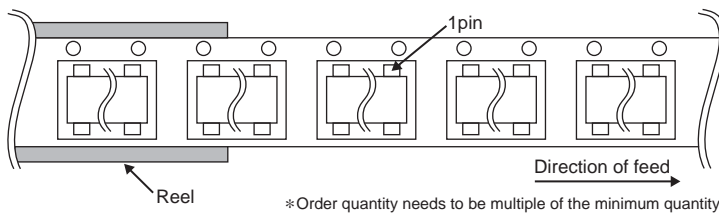

Notes

No copying or reproduction of this document, in part or in whole, is permitted without the consent of ROHM Co.,Ltd.

The content specified herein is subject to change for improvement without notice.

The content specified herein is for the purpose of introducing ROHM's products (hereinafter "Products"). If you wish to use any such Product, please be sure to refer to the specifications, which can be obtained from ROHM upon request.

Examples of application circuits, circuit constants and any other information contained herein illustrate the standard usage and operations of the Products. The peripheral conditions must be taken into account when designing circuits for mass production.

Great care was taken in ensuring the accuracy of the information specified in this document. However, should you incur any damage arising from any inaccuracy or misprint of such information, ROHM shall bear no responsibility for such damage.

The technical information specified herein is intended only to show the typical functions of and examples of application circuits for the Products. ROHM does not grant you, explicitly or implicitly, any license to use or exercise intellectual property or other rights held by ROHM and other parties. ROHM shall bear no responsibility whatsoever for any dispute arising from the use of such technical information.

The Products specified in this document are intended to be used with general-use electronic equipment or devices (such as audio visual equipment, office-automation equipment, communication devices, electronic appliances and amusement devices).

The Products specified in this document are not designed to be radiation tolerant.

While ROHM always makes efforts to enhance the quality and reliability of its Products, a Product may fail or malfunction for a variety of reasons.

Please be sure to implement in your equipment using the Products safety measures to guard against the possibility of physical injury, fire or any other damage caused in the event of the failure of any Product, such as derating, redundancy, fire control and fail-safe designs. ROHM shall bear no responsibility whatsoever for your use of any Product outside of the prescribed scope or not in accordance with the instruction manual.

The Products are not designed or manufactured to be used with any equipment, device or system which requires an extremely high level of reliability the failure or malfunction of which may result in a direct threat to human life or create a risk of human injury (such as a medical instrument, transportation equipment, aerospace machinery, nuclear-reactor controller, fuel-controller or other safety device). ROHM shall bear no responsibility in any way for use of any of the Products for the above special purposes. If a Product is intended to be used for any such special purpose, please contact a ROHM sales representative before purchasing.

If you intend to export or ship overseas any Product or technology specified herein that may be controlled under the Foreign Exchange and the Foreign Trade Law, you will be required to obtain a license or permit under the Law.



Thank you for your accessing to ROHM product informations.
More detail product informations and catalogs are available, please contact us.

ROHM Customer Support System

<http://www.rohm.com/contact/>