

LM2647 Dual Synchronous Buck Regulator Controller

Check for Samples: [LM2647](#)

FEATURES

- **Input Voltage Range from 5.5V to 28V**
- **Synchronous Dual-channel Interleaved Switching**
- **Forced-PWM or Pulse-skip Modes**
- **Lossless Bottom-side FET Current Sensing**
- **Adaptive Duty Cycle Clamping**
- **High Current N-channel FET Drivers**
- **Low Shutdown Supply Currents**
- **Reference Voltage Accurate to Within $\pm 1.5\%$**
- **Output Voltage Adjustable down to 0.6V**
- **Power Good flag and Chip Enable**
- **Under-voltage Lockout**
- **Over-voltage/Under-voltage Protection**
- **Soft-start and Soft-shutdown**
- **Switching Frequency Adjustable 200kHz-500kHz**

APPLICATIONS

- **Notebook Chipset Power Supplies**
- **Low Output Voltage High-Efficiency Buck Regulators**

DESCRIPTION

The LM2647 is an adjustable 200-500kHz dual channel voltage-mode controlled high-speed synchronous buck regulator controller ideally suited for battery powered applications such as laptop and notebook computers. The LM2647 requires only N-channel FETs for both the upper and lower positions of each synchronous stage. It features line feedforward to improve the response to input transients. At very light loads, the user can choose between the high-efficiency Pulse-skip mode or the constant frequency Forced-PWM mode. Lossless current limiting without the use of external sense resistors is made possible by sensing the voltage drop across the bottom FET. A unique adaptive duty cycle clamping technique is incorporated to significantly reduce peak currents under abnormal load conditions. The two independently programmable outputs switch 180° out of phase (interleaved switching) to reduce the input capacitor and filter requirements. The input voltage range is 5.5V to 28V while the output voltages are adjustable down to 0.6V.

Standard supervisory and control features include Soft-start, Power Good, output Under-voltage and Over-voltage protection, Under-voltage Lockout, Soft-shutdown and Enable.



Please be aware that an important notice concerning availability, standard warranty, and use in critical applications of Texas Instruments semiconductor products and disclaimers thereto appears at the end of this data sheet.

All trademarks are the property of their respective owners.

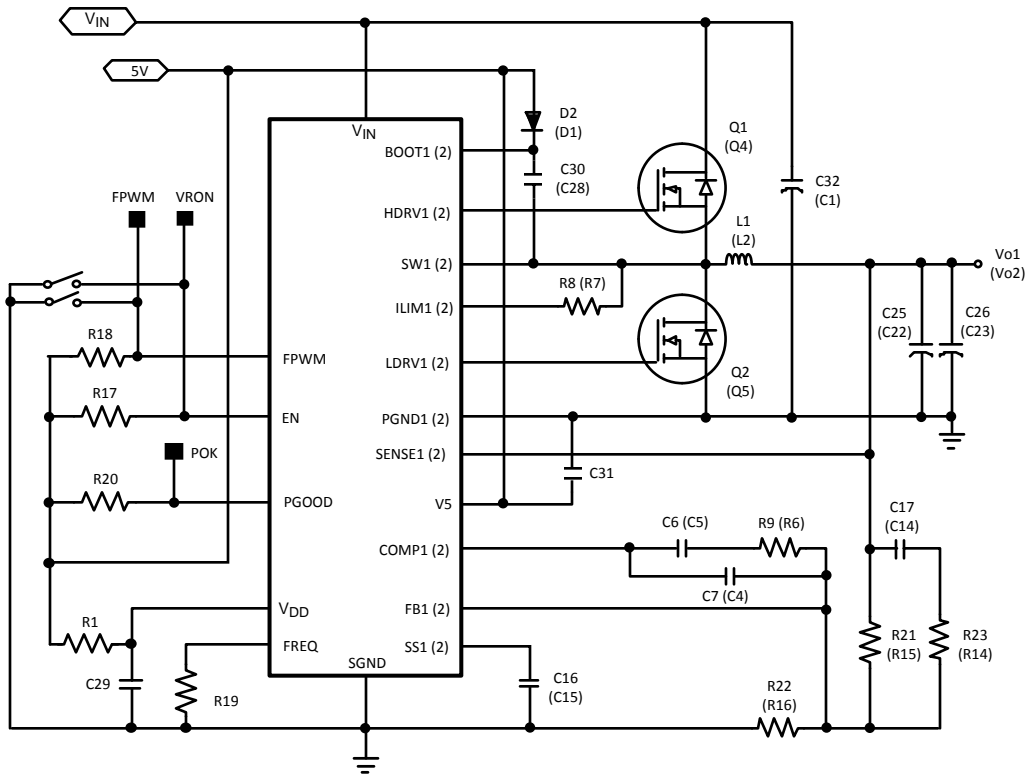

Figure 1. Typical Application (Channel 2 in parenthesis)
See Figure 24 for Expanded View

Connection Diagrams

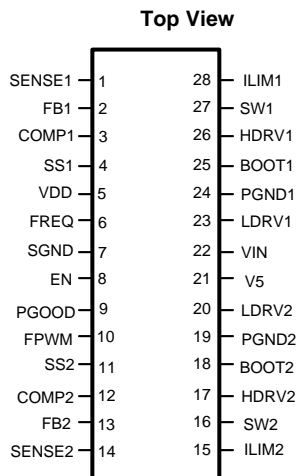

Figure 2. 28-Lead TSSOP Package
See Package Number PW0028A

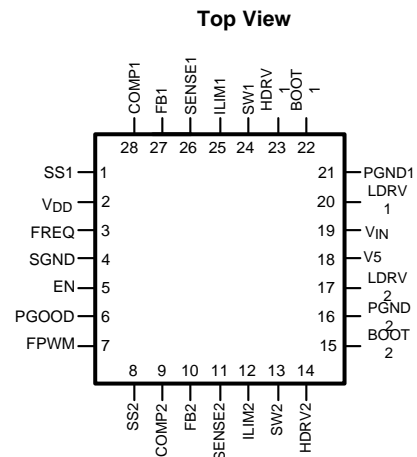

Figure 3. 28-Lead WQFN Package
See Package Number NJB0028A

PIN DESCRIPTION

(All pin numbers referred to here correspond to the TSSOP package)

Pin 1, SENSE1: Output voltage sense pin for Channel 1. It is tied directly to the output rail. The SENSE pin voltage is used together with the VIN voltage (on Pin 22) to (internally) calculate the CCM (continuous conduction mode) duty cycle. This calculation is used by the IC to set the minimum duty cycle in the SKIP mode to 85% of the CCM value. It is also used to set the adaptive duty cycle clamp (see Pin 3). An internal 20Ω resistor from the SENSE pin to ground discharges the output capacitor gently (Soft-shutdown) whenever Power Not Good is signaled on Pin 9.

Pin 2, FB1: Feedback pin for Channel 1. This is the inverting input of the error amplifier. The voltage on this pin under regulation is nominally at 0.6V. A Power Good window on this pin determines if the output voltage is within regulation limits (±13%). If the voltage (on either channel) falls outside this window for more than 7μs, Power Not Good is signaled on the PGOOD pin (Pin 9). Output over-voltage and under-voltage conditions are also detected by comparing the voltage on the Feedback pin with appropriate internal reference voltage levels. If the voltage exceeds the safe window (±30%) for longer than 7μs, a fault condition is asserted. Then both the lower FETs are latched ON and the upper FETs are latched OFF. When single channel operation is desired, the Feedback pins of both channels should be connected together, near the IC. All other pins specific to the unused channel should be left floating (not connected to each other either).

Pin 3, COMP1: Compensation pin for Channel 1. This is also the output of the error amplifier of this channel. The voltage level on this pin is compared with an internally generated ramp signal to set the duty cycle for normal regulation. Since the Feedback pin is the inverting input of the same error amplifier, appropriate control loop compensation components are placed between this pin and the Feedback pin. The COMP pin is internally pulled low during Soft-start so as to limit the duty cycle. Once Soft-start is completed, the voltage on this pin can take up the value required to maintain output regulation. But an internal voltage clamp does not allow the pin to go much higher than the steady-state requirement. This forms the adaptive duty cycle clamp feature which serves to limit the maximum allowable duty cycle and peak currents under sudden overloads. But at the same time it has enough headroom to permit an adequate response to step loads within the normal operating range.

Pin 4, SS1: Channel 1 Soft-start pin. A Soft-start capacitor is placed between this pin and ground. A typical capacitance of 0.1μF is always recommended between this pin and ground. The IC connects an internal 1.8 kΩ resistor (R_{SS_DCHG} , see [Electrical Characteristics](#) table) between this pin and ground to discharge any remaining charge on the Soft-start capacitor under several conditions. These conditions include the initial power-up sequence, start-up by toggling the EN pin, and also recovery from a fault condition. The purpose is to bring down the voltage on both the Soft-start pins to below 100mV for obtaining reset. Reset having thus been obtained, an 11μA current source at this pin charges up the Soft-start capacitor. The voltage on this pin controls the maximum duty cycle, and this produces a gradual ramp-up of the output voltage, thereby preventing large inrush currents into the output capacitors. The voltage on this pin finally clamps close to 5V. This pin is again connected to the internal 115μA current sink whenever a current limit event is in progress. This sink current discharges the Soft-start capacitor and forces the duty cycle low to protect the power components. When a fault condition is asserted (See Pin 2) the SS pin is internally connected to ground via the 1.8 kΩ resistor.

Pin 5, VDD: 5V supply rail for the control and logic sections of both channels. For normal operation to start, the voltage on this pin must be brought above 4.5V. Subsequently, the voltage on this pin (including any ripple component) should not allowed to fall below 4V for a duration longer than 7μs. Since this pin is also the supply rail for the internal control sections, it should be well-decoupled particularly at high frequencies. A minimum 0.1μF-0.47μF (ceramic) capacitor should be placed on the component side very close to the IC with no intervening vias between this capacitor and the VDD/SGND pins. If the voltage on Pin 5 falls below the lower UVLO threshold, both upper FETs are latched OFF and lower FETs latched ON. Power Not Good is then also signaled immediately (on Pin 9). To effect recovery, the EN pin must be taken below 0.8V and then back above 2V (with VDD held above 4.5V). Or the voltage on the VDD pin must be taken below 1.0V and then back again above 4.5V (with EN pin held above 2V). Normal operation will then resume assuming that the fault condition has cleared.

Pin 6, FREQ: Frequency adjust pin. The switching frequency (for both channels) is set by a resistor connected between this pin and ground. A value of 22.1kΩ sets the frequency to 300kHz (nominal). If the resistance is increased, the switching frequency falls. An approximate relationship is that for every 7.3kΩ increase (or decrease) in the value of the frequency adjust resistance, the time period (1/f) increases (or decreases) by about 1μs.

Pin 7, SGND: Signal Ground pin. This is the lower rail for the control and logic sections of both channels. SGND should be connected on the PCB to the system ground, which in turn is connected to PGND1 and PGND2. The layout is important and the recommendations in the section [LAYOUT GUIDELINES](#) should be followed.

Pin 8, EN: IC Enable pin. When EN is taken high, both channels are enabled by means of a Soft-start power-up sequence (see Pin 4). When EN is brought low, Power Not Good is signaled within 100ns. This causes Soft-shutdown to occur (see Pins 1 and 9). The Soft-start capacitor is then discharged by an internal 1.8kΩ resistor (R_{SS_DCHG} , see [Electrical Characteristics](#) table). But note that when the Enable pin is toggled, a fault condition is not asserted. Therefore in this case, the lower FETs are not latched ON, even as the output voltage ramps down, eventually falling below the under-voltage threshold. In fact, in this situation, both the upper and the lower FETs of the two channels are latched OFF, until the Enable pin is taken high again. If a fault shutdown has occurred, taking the Enable pin low and then high again (toggling), resets the internal latches, and the IC will resume normal switching operation.

Pin 9, PGOOD: Power Good output pin. An open-Drain logic output that is pulled high with an external pull-up resistor, indicating that both output voltages are within a pre-defined Power Good window. Outside this window, the pin is internally pulled low (Power Not Good signaled) provided the output error lasts for more than 7μs. But the pin is also pulled low within 100ns of the Enable pin being taken low, irrespective of the output voltage level. Note that PGOOD must always be high before it can respond by going low. So regulation on both channels must be achieved first. Further, for fault monitoring to be in place, PGOOD must have been high prior to occurrence of the fault condition. Note that since under a fault assertion, the lower FETs are always latched ON, this will not happen if regulation has not been already been achieved first. For correct signaling on this pin under single-channel operation, see description of Pin 2.

PIN DESCRIPTION (continued)

<p>Pin 10, FPWM: Logic input for selecting either the Forced PWM (FPWM) Mode or Pulse-skip Mode (SKIP) for both channels (together). When the pin is driven high, the IC operates in the FPWM mode, and when pulled low or left floating, the SKIP mode is enabled. In FPWM mode, the lower FET of a given channel is always ON whenever the upper FET is OFF (except for a narrow shoot-through protection deadband). This leads to continuous conduction mode of operation, which has a fixed frequency and (almost) fixed duty cycle down to very light loads. But this does reduce efficiency at light loads. The alternative is the SKIP mode, where the lower FET remains ON only until the voltage on the Switch pin (see Pin 27 or Pin 16) is more negative than 2.2mV (typical). So for example, for a 21mΩ FET, this translates to a current threshold of $2.2\text{mV}/21\text{m}\Omega = 0.1\text{A}$. Therefore, if the (instantaneous) inductor current falls below this value, the lower FET will turn OFF every cycle at this point (when operated in SKIP mode). This threshold is set by the zero-cross Comparator in the Figure 4. Note that if the inductor current waveform is high enough to be always above this zero-cross threshold ($V_{\text{SW_ZERO}}$, see Table of Electrical Characteristics), there will be no observable difference between FPWM and SKIP mode settings (in steady-state). SKIP mode, when it actually occurs, is clearly a discontinuous mode of operation. However, note that in conventional discontinuous mode, the duty cycle keeps falling (towards zero) as the load decreases. But the LM2647 does not allow the duty cycle to fall by more than 15% of its original value (at the CCM-DCM boundary). This forces pulse-skipping, and the average frequency is effectively decreased as the load decreases. This mode of operation improves efficiency at light loads, but the frequency is effectively no longer a constant. Note that a <i>minimum pre-load of 0.1mA should be maintained on the output of each channel to ensure regulation in SKIP mode</i>. The resistive divider from output to ground used to set the output voltage could be designed to serve as part or all of this required pre-load.</p>
<p>Pin 11, SS2: Soft-start pin for Channel 2. See Pin 4.</p>
<p>Pin 12, COMP2: Soft-start pin for Channel 2. See Pin 3.</p>
<p>Pin 13, FB2: Feedback pin for Channel 2. See Pin 2.</p>
<p>Pin 14, SENSE2: Output voltage sense pin for Channel 2. See Pin 1.</p>
<p>Pin 15, ILIM2: Channel 2 Current Limit pin. When the bottom FET is ON, a 62μA (typical) current flows out of this pin into an external current limit setting resistor connected to the Drain of the lower FET. This is a current source, therefore the drop across this resistor serves to push the voltage on this pin to a more positive value. However, the Drain of the lower FET which is connected to the other side of the same resistor is trying to go more negative as the load current increases. At some value of instantaneous current, the voltage on this pin will transit from positive to negative. The point where it is zero is the current limiting condition and is detected by the Current Limit Comparator in the Figure 4. When current limit condition has been detected, the next ON-pulse of the upper FET will be omitted. The lower FET will again be monitored to determine if the current has fallen below the threshold. If it has, the next ON-pulse will be permitted. If not, the upper FET will be turned OFF and will stay so for several cycles if necessary, until the current returns to normal. Eventually, if the overcurrent condition persists, and the upper FET has not been turned ON, the output will clearly start to fall. Ultimately the output will fall below the under-voltage threshold, and a fault condition will be asserted by the IC.</p>
<p>Pin 16, SW2: The Switching node of the buck regulator of Channel 2. Also serves as the lower rail of the floating driver of the upper FET.</p>
<p>Pin 17, HDRV2: Gate drive pin for the upper FET of Channel 2 (High-side drive). The top gate driver is interlocked with the bottom gate driver to prevent shoot-through/cross-conduction.</p>
<p>Pin 18, BOOT2: Bootstrap pin for Channel 2. This is the upper supply rail for the floating driver of the upper FET. It is bootstrapped by means of a ceramic capacitor connected to the channel Switching node. This capacitor is charged up by the IC to a value of about 5V as derived from the V5 pin (Pin 21).</p>
<p>Pin 19, PGND2: Power Ground pin of Channel 2. This is the return path for the bottom FET gate drive. Both the PGND's are to be connected on the PCB to the system ground and also to the Signal ground (Pin 7) in accordance with the recommended LAYOUT GUIDELINES.</p>
<p>Pin 20, LDRV2: Gate drive pin for the Channel 2 bottom FET (Low-side drive). The bottom gate driver is interlocked with the top gate driver to prevent shoot-through/cross-conduction. It is always latched high when a fault condition is asserted by the IC.</p>
<p>Pin 21, V5: Upper rail of the lower FET drivers of both channels. Also used to charge up the bootstrap capacitors of the upper FET drivers. This is connected to an external 5V supply. The 5V rail may be the same as the rail used to provide power to the VDD pin (Pin 5), but the VDD pin will then require to be well-decoupled so that it does not interact with the V5 pin. A low-pass RC filter consisting of a ceramic 0.1μF capacitor (preferably 0.22μF) and a 10Ω resistor will suffice as shown in the Typical Applications circuit.</p>
<p>Pin 22, VIN: The input to both the Buck regulator power stages. It also is used by the internal ramp generator to implement the line feedforward feature. The VIN pin is also used with the SENSE pin voltage to predict the CCM (continuous conduction mode) duty cycle and to thereby set the minimum allowed DCM duty cycle to 85% of the CCM value (in SKIP mode, see Pin 10). This is a high input impedance pin, drawing only about 100μA (typical) from the input rail.</p>
<p>Pin 23, LDRV1: LDRV pin of Channel 1. See Pin 20.</p>
<p>Pin 24, PGND1: PGND pin for Channel 1. See Pin 19.</p>
<p>Pin 25, BOOT1: Boot pin of Channel 1. See Pin 18.</p>
<p>Pin 26, HDRV1: HDRV pin of Channel 1. See Pin 17.</p>
<p>Pin 27, SW1: SW pin of Channel 1. See Pin 16.</p>
<p>Pin 28, ILIM1: Channel 1 Current Limit pin. See Pin 15.</p>



These devices have limited built-in ESD protection. The leads should be shorted together or the device placed in conductive foam during storage or handling to prevent electrostatic damage to the MOS gates.

Absolute Maximum Ratings⁽¹⁾⁽²⁾

Voltages from the indicated pins to SGND/PGND unless otherwise indicated.⁽³⁾

VIN		30V
V5		7V
VDD		7V
BOOT1, BOOT2		36V
BOOT1 to SW1, BOOT2 to SW2		7V
SW1, SW2		30V
ILIM1, ILIM2		30V
SENSE1, SENSE2, FB1, FB2		7V
PGOOD		7V
EN		7V
Power Dissipation ($T_A = 25^\circ\text{C}$) ⁽⁴⁾		1.0W
Junction Temperature		+150°C
ESD Rating ⁽⁵⁾		2kV
Ambient Storage Temperature Range		-65°C to +150°C
Soldering Dwell Time, Temperature	Wave	4 sec, 260°C
	Infrared	10 sec, 240°C
	Vapor Phase	75 sec, 219°C

- (1) Absolute maximum ratings indicate limits beyond which damage to the device may occur. Operating Ratings are conditions under which operation of the device is ensured. For ensured performance limits and associated test conditions, see the Electrical Characteristics table.
- (2) If Military/Aerospace specified devices are required, please contact the Texas Instruments Sales Office/ Distributors for availability and specifications.
- (3) PGND1, PGND2 and SGND are all electrically connected together on the PCB.
- (4) The maximum allowable power dissipation is calculated by using $P_{Dmax} = (T_{JMAX} - T_A) / \theta_{JA}$, where T_{JMAX} is the maximum junction temperature, T_A is the ambient temperature, and θ_{JA} is the junction-to-ambient thermal resistance of the specified package. The 1.0W rating of the TSSOP-28 package for example results from using 125°C, 25°C, and 97°C/W for T_{JMAX} , T_A , and θ_{JA} respectively. The 2.85W rating of the 28-pin WQFN package results from using 125°C, 25°C, and 35°C/W for T_{JMAX} , T_A , and θ_{JA} respectively. The rated power dissipation should be derated by 10mW/°C above 25°C ambient for the TSSOP package and 29mW/°C above 25°C ambient for the WQFN package. The θ_{JA} value above represents the worst-case condition with no heat sinking. Heat sinking will permit more power to be dissipated at higher ambient temperatures. For detailed information on soldering plastic TSSOP and WQFN packages, refer to <http://www.ti.com/packaging/>.
- (5) ESD is applied by the human body model, which is a 100pF capacitor discharged through a 1.5 kΩ resistor into each pin.

Operating Ratings⁽¹⁾

VIN	5.5V to 28V
VDD, V5	4.5V to 5.5V
Junction Temperature	-5°C to +125°C

- (1) Absolute maximum ratings indicate limits beyond which damage to the device may occur. Operating Ratings are conditions under which operation of the device is ensured. For ensured performance limits and associated test conditions, see the Electrical Characteristics table.

Electrical Characteristics

Specifications with standard typeface are for $T_j = 25^\circ\text{C}$, and those with **boldface** apply over full Operating Junction Temperature range. $V_{DD} = V_5 = 5\text{V}$, $V_{SGND} = V_{PGND} = 0\text{V}$, $V_{IN} = 15\text{V}$, $V_{EN} = 3\text{V}$, $R_{FADJ} = 22.1\text{K}$ unless otherwise stated.⁽¹⁾

Symbol	Parameter	Conditions	Min ⁽²⁾	Typical ⁽³⁾	Max ⁽²⁾	Units
Reference						
V_{FB_REG}	FB Pin Voltage at Regulation (either FB Pin)	$V_{DD} = 4.5\text{V to } 5.5\text{V}$, $V_{IN} = 5.5\text{V to } 28\text{V}$	591	600	609	mV
	V_{FB} Line Regulation	$V_{DD} = 4.5\text{V to } 5.5\text{V}$, $V_{IN} = 5.5\text{V to } 28\text{V}$		0.5		
I_{FB}	FB Pin Current (sourcing)	V_{FB} at regulation		20	100	nA
Chip Supply						
I_{Q_VIN}	VIN Quiescent Current	$V_{FB1} = V_{FB2} = 0.7\text{V}$		100	200	μA
I_{SD_VN}	VIN Shutdown Current	$V_{EN} = 0\text{V}$		0	5	μA
I_{Q_VDD}	VDD Quiescent Current	$V_{FB1} = V_{FB2} = 0.7\text{V}$		2.5	4	mA
I_{SD_VDD}	VDD Shutdown Current	$V_{EN} = 0\text{V}$		8	15	μA
I_{Q_V5}	V5 Normal Operating Current	$V_{FB1} = V_{FB2} = 0.7\text{V}$		0.3	0.5	mA
		$V_{FB1} = V_{FB2} = 0.5\text{V}$		1	1.5	
I_{SD_V5}	V5 Shutdown Current	$V_{EN} = 0\text{V}$		0	5	μA
I_{Q_BOOT}	BOOT Quiescent Current	$V_{FB1} = V_{FB2} = 0.7\text{V}$		2	5	μA
		$V_{FB1} = V_{FB2} = 0.5\text{V}$		300	500	
I_{SD_BOOT}	BOOT Shutdown Current	$V_{EN} = 0\text{V}$		1	5	μA
V_{UVLO}	VDD UVLO Threshold	VDD rising from 0V	3.9	4.2	4.5	V
	VDD UVLO Hysteresis	VDD = V5 falling from V_{UVLO}	0.5	0.7	0.9	V
Logic						
I_{EN}	EN Input Current	$V_{EN} = 0 \text{ to } 5\text{V}$		0		μA
V_{EN_HI}	EN Input Logic High		2	1.8		V
V_{EN_LO}	EN Input Logic Low			1.3	0.8	V
	FPWM Pull-down	$V_{FPWM} = 2\text{V}$	100	200	1000	k Ω
V_{FPWM_HI}	FPWM Input Logic High		2	1.8		V
V_{FPWM_LO}	FPWM Input Logic Low			1.3	0.8	V
Power Good						
V_{PGOOD_HI}	Power Good Upper Threshold as a Percentage of Internal Reference	FB voltage rising above V_{FB_REG}	110	113	116	%
V_{PGOOD_LOW}	Power Good Lower Threshold as a Percentage of Internal Reference	FB voltage falling below V_{FB_REG}	84	87	90	%
	Power Good Hysteresis			7		
Δt_{PG_OK}	Power Good Delay	From both output voltages "good" to PGOOD assertion.	10	20	30	μs
Δt_{PG_NOK}		From the first output voltage "bad" to PGOOD de-assertion	4	7	10	
Δt_{SD}		From Enable low to PGOOD low		0.03	0.1	
	PGOOD Saturation Voltage	PGOOD de-asserted (Power Not Good) and sinking 1.5mA		0.12	0.4	V
	PGOOD Leakage Current	PGOOD = 5V and asserted		0	1	μA
OV and UV Protection						
	Fault OVP Latch Threshold as a Percentage of Internal Reference	FB voltage rising above V_{FB_REG}	125	130	135	%

(1) R_{FADJ} is the frequency adjust resistor between FREQ pin and Ground.

(2) All limits are specified at room temperature (standard face type) and at temperature extremes (bold face type). All room temperature limits are 100% production tested. All limits at temperature extremes are specified via correlation using Statistical Quality Control (SQC) methods. All limits are used to calculate Average Outgoing Quality Level (AOQL).

(3) Typical numbers are at 25°C and represent the most likely norm.

Electrical Characteristics (continued)

Specifications with standard typeface are for $T_j = 25^\circ\text{C}$, and those with **boldface** apply over full Operating Junction Temperature range. $V_{DD} = V_5 = 5\text{V}$, $V_{SGND} = V_{PGND} = 0\text{V}$, $V_{IN} = 15\text{V}$, $V_{EN} = 3\text{V}$, $R_{FADJ} = 22.1\text{K}$ unless otherwise stated.⁽¹⁾

Symbol	Parameter	Conditions	Min ⁽²⁾	Typical ⁽³⁾	Max ⁽²⁾	Units
	Fault UVP Latch Threshold as a Percentage of Internal Reference	FB voltage falling below V_{FB_REG}	65	70	75	%
Δt_{FAULT}	Fault Delay	From Fault detection (any output) to Fault assertion		7		μs
Soft-start						
I_{SS_CHG}	Soft-start Charging Current	$V_{SS} = 1\text{V}$	8	11	14	μA
R_{SS_DCHG}	Soft-shutdown Resistance (SS pin to SGND, either channel)	$V_{EN} = 0\text{V}$, $V_{SS} = 1\text{V}$		1800		Ω
I_{SS_DCHG}	Soft-start Discharge Current	In Current Limit	80	115	160	μA
V_{SS_RESET}	Soft-start pin reset voltage ⁽⁴⁾	SS charged to 0.5V, EN low to high		100		mV
	SS to COMP Offset Voltage	$V_{SS} = 0.5\text{V}$ and 1V , $V_{FB1} = V_{FB2} = 0\text{V}$		600		mV
Error Amplifier						
GAIN	DC Gain			70		dB
	Voltage Slew Rate	COMP rising		4.45		V/ μs
		COMP falling		2.25		
BW	Unity Gain Bandwidth	COMP falling		6.5		MHz
	COMP Source Current	$V_{FB} < V_{FB_REG}$ $V_{COMP} = 0.5\text{V}$	2	5		mA
	COMP Sink Current	$V_{FB} > V_{FB_REG}$ $V_{COMP} = 0.5\text{V}$	7	14		mA
Current Limit and Zero-Cross						
I_{LIM}	I_{LIM} Pin Current (sourcing, either I_{LIM} pin)	$V_{LIM1} = V_{LIM2} = 0\text{V}$	46	62	76	μA
	I_{LIM} Threshold Voltage		-10	0	10	mV
V_{SW_ZERO}	Zero-cross Threshold (SW Pin)	LDRV goes low		-2.2		mV
Oscillator						
	PWM Frequency	$R_{FADJ} = 22.1\text{k}\Omega$	255	300	345	kHz
		$R_{FADJ} = 12.4\text{k}\Omega$		500		
		$R_{FADJ} = 30.9\text{k}\Omega$		200		
	PWM Ramp Peak-to-peak Amplitude	$V_{IN} = 15\text{V}$		1.6		V
		$V_{IN} = 24\text{V}$		2.95		
	PWM Ramp Valley			0.8		V
	Frequency Change with V_{IN}	$V_{IN} = 5.5\text{V}$ to 24V		± 1		%
	Frequency Change with V_{DD}	$V_{DD} = 4.5\text{V}$ to 5.5V		± 2		%
	Phase Shift Between Channels	Phase from HDRV1 to HDRV2	165	180	195	deg
	FREQ Pin Voltage vs. V_{IN}			0.105		V/V
System						
	Minimum ON Time	$V_{FPWM} = 3\text{V}$		30		ns
		$V_{IN} = 5.5\text{V}$	60	75		%
	Maximum Duty Cycle	$V_{IN} = 15\text{V}$	40	50		%
		$V_{IN} = 28\text{V}$, $V_{DD} = 4.5\text{V}$	22	28		%
Gate Drivers						
	HDRV Source Impedance	HDRV Pin Current (sourcing) = 1.2A		7		Ω
	HDRV Sink Impedance	HDRV Pin Current (sinking) = 1A		2		Ω

(4) If the LM2647 starts up with a pre-charged soft start capacitor, it will first discharge the capacitor to V_{SS_RESET} and then begin the normal Soft-start process.

Electrical Characteristics (continued)

Specifications with standard typeface are for $T_J = 25^\circ\text{C}$, and those with **boldface** apply over full Operating Junction Temperature range. $V_{DD} = V_5 = 5\text{V}$, $V_{SGND} = V_{PGND} = 0\text{V}$, $V_{IN} = 15\text{V}$, $V_{EN} = 3\text{V}$, $R_{FADJ} = 22.1\text{K}$ unless otherwise stated.⁽¹⁾

Symbol	Parameter	Conditions	Min ⁽²⁾	Typical ⁽³⁾	Max ⁽²⁾	Units
	LDRV Source Impedance	LDRV Pin Current (sourcing) = 1.2A		7		Ω
	LDRV Sink Impedance	LDRV Pin Current (sinking) = 2A		1		Ω
	Cross-conduction protection delay (deadtime)	HDRV Falling to LDRV Rising		40		ns
		LDRV Falling to HDRV Rising		70		

Block Diagram

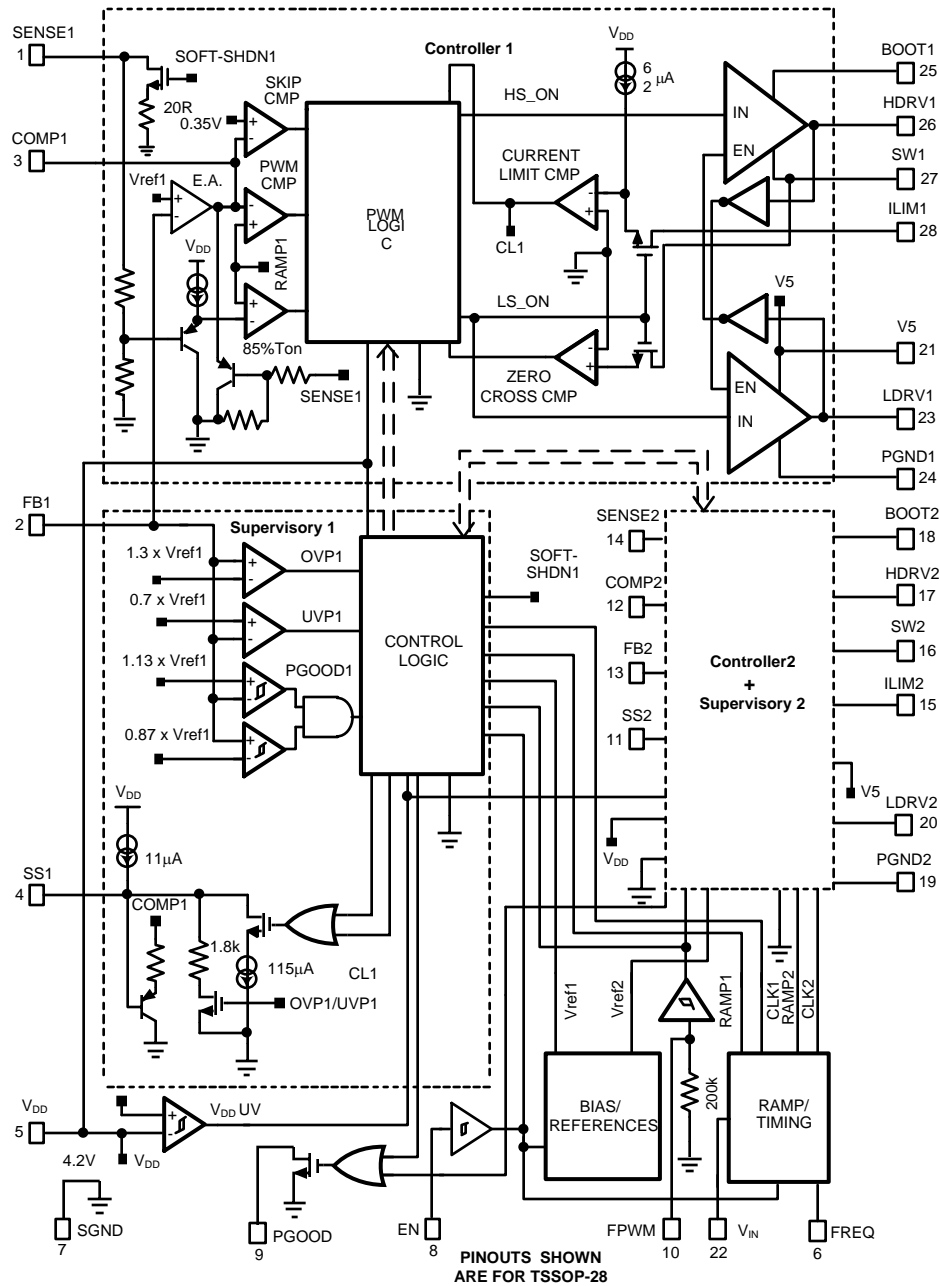

Figure 4. Block Diagram

Typical Performance Characteristics

Input Voltage is 15V, 20V, 24V, 28V (in order) starting from uppermost curve to lowermost curve in each of the Efficiency plots below.

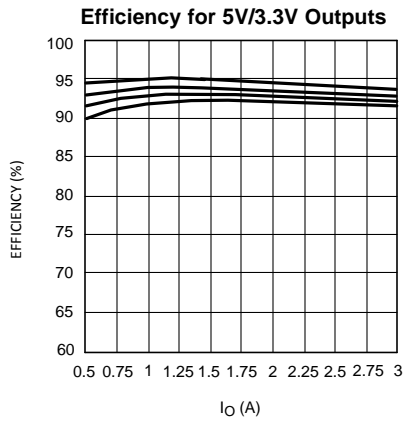

Figure 5.

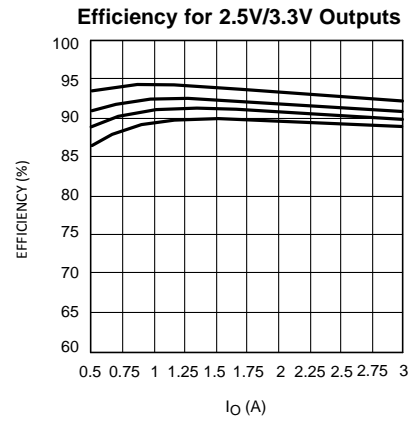

Figure 6.

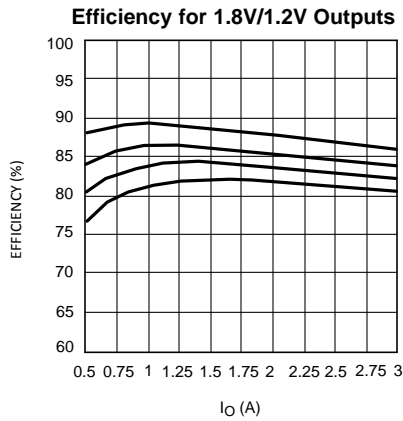

Figure 7.

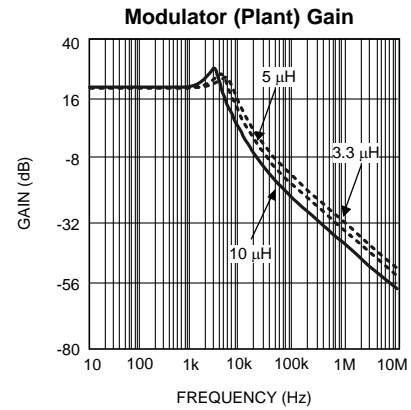

Figure 8.

OPERATION DESCRIPTIONS

GENERAL

The LM2647 provides two identical synchronously switched buck regulator channels that operate 180° out of phase. A voltage-mode control topology was selected to provide fixed-frequency PWM regulation at very low duty cycles, in preference to current-mode control, because the latter has inherent limitations in being able to achieve low pulse widths due to blanking time requirements. Because of a minimum pulse width of about 30ns for the LM2647, very low duty cycles (low output, high input) are possible. The main advantage of current-mode control is the fact that the slope of its ramp (derived from the switch current), automatically increases with increase in input voltage. This leads to improved line rejection and fast response to line variations. In typical voltage-mode control, the ramp is derived from the clock, not from the switch current. But by using the input voltage together with the clock signal to generate the ramp as in the LM2647, this advantage of current-mode control can in fact be completely replicated. The technique is called line feedforward. In addition, the LM2647 features a user-selectable Pulse-skip mode that significantly improves efficiency at light loads by reducing switching losses, and driver consumption, both of which are proportional to switching frequency.

INPUT VOLTAGE FEEDFORWARD

The feedforward circuit of the LM2647 adjusts the slope of the internal PWM ramp in proportion to the regulator input voltage. See [Figure 9](#) for an illustration of how the duty cycle changes as a result of the change in the slope of the ramp, even though the error amplifier output has not had time to react to the line disturbance. The almost instantaneous duty cycle correction provided by the feedforward circuit significantly improves line transient rejection.

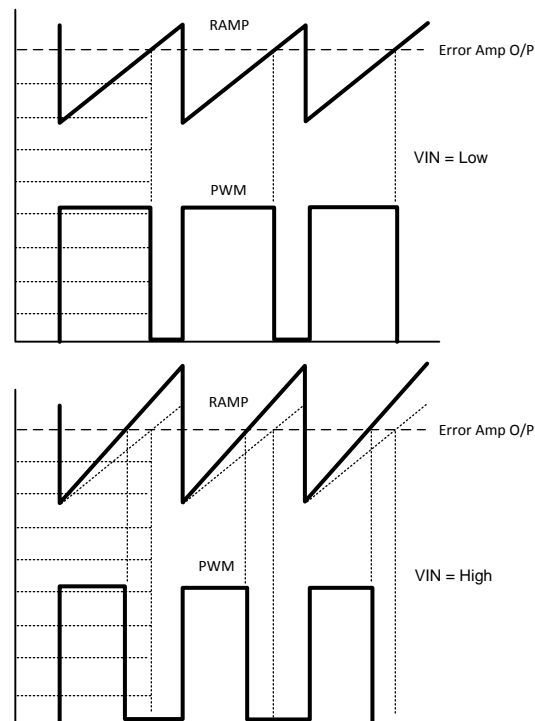
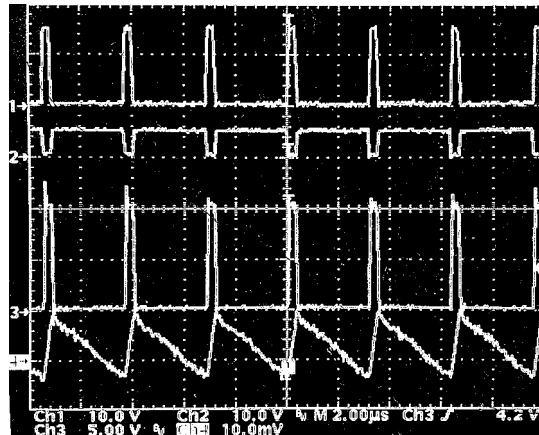

Figure 9. Voltage Feedforward

FORCED-PWM MODE AND PULSE-SKIP MODE

Forced-PWM mode (FPWM) leads to Continuous Conduction Mode (CCM) even at very light loads. It is one of two user-selectable modes of operation provided by the LM2647. When FPWM is chosen (FPWM pin high), the bottom FET will always be turned ON whenever the top FET is OFF. See [Figure 10](#) for a typical FPWM plot.



CH1: HDRV, CH2: LDRV, CH3: SW, CH4: I_L (0.2A/div)
Output 1V @ 0.04A, $V_{IN} = 10V$, FPWM, $L = 10\mu H$, $f = 300kHz$

Figure 10. Normal FPWM Mode Operation at Light Loads

In a conventional converter, as the load is decreased to about 10-30% of maximum load current, DCM (Discontinuous Conduction Mode) occurs. In this condition the inductor current falls to zero during the OFF-time, and stays there until the start of the next switching cycle. In this mode, if the load is decreased further, the duty cycle decreases (pinches off), and ultimately may decrease to the point where the required pulse width becomes less than the minimum ON-time achievable by the converter (controller + FETs). Then a sort of random skipping behavior occurs as the error amplifier struggles to maintain regulation. This is not the most desirable type of behavior. There are two ways out of this problem.

One way is to keep the lower FET ON until the start of the next cycle (as in the LM2647 operated in FPWM mode). This allows the inductor current to drop to zero and then actually reverse direction (negative direction through inductor, passing from Drain to Source of lower FET, see Channel 4 in [Figure 10](#)). Now the current can continue to flow continuously till the end of the switching cycle. This maintains CCM and so the duty cycle does not start to pinch off as in typical DCM. Nor does it lead to the undesirable random skipping described above. Note that the pulse width (duty cycle) for CCM is virtually constant for any load and therefore does not usually run into the minimum ON-time restriction. But it can happen, especially when the application consists of a very high input voltage, a low output voltage rail, and also the switching frequency is set high. Let us check the LM2647 to rule out this remote possibility. For example, with an input of 24V, an output of 1V, the duty cycle is $1/24 = 4.2\%$. This leads to a required ON-time of $0.042 * 3.3 = 0.14 \mu s$ at a switching frequency of 300kHz ($T=3.3 \mu s$). Since 140ns exceeds the minimum ON-time of 30ns of the LM2647, normal constant frequency CCM mode of operation is assured in FPWM mode, at virtually any load.

The second way out of the problems of discontinuous mode is the second operating mode of the LM2647, the Pulse-skip (SKIP) Mode. In SKIP Mode, a zero-cross detector at the SW pin turns off the bottom FET when the inductor current decays to zero (actually at V_{SW_ZERO} , see [Electrical Characteristics](#) table). This would however still amount to conventional DCM, with its attendant problems at extremely light loads as described earlier. The LM2647 however avoids the random skipping behavior described earlier, and replaces it with a more defined or formal SKIP mode. In conventional DCM, a converter would try to reduce its duty cycle from the CCM value as the load decreases, as explained previously. So it would start with the CCM duty cycle value (at the CCM-DCM boundary), but as the load decreases, the duty cycle would try to shrink to zero. However, in the LM2647, the DCM duty cycle is not allowed to fall below 85% of the CCM value. So when the theoretically required DCM duty cycle value falls below what the LM2647 is allowed to deliver (in this mode), pulse-skipping starts. It will be seen that several of these excess pulses may be delivered, until the output capacitors charge up enough to notify the error amplifier and cause its output to reverse. Thereafter several pulses could be skipped entirely until the output of the error amplifier again reverses. The SKIP mode therefore leads to a reduction in the average switching frequency. Switching losses and FET driver losses, both of which are proportional to frequency, are significantly reduced at very light loads and efficiency is boosted. SKIP mode also reduces the circulating currents and energy associated with the FPWM mode. See [Figure 11](#) for a typical plot of SKIP mode at very light

loads. Note the bunching of several fixed-width pulses followed by skipped pulses. The average frequency can actually fall very low at very light loads. Note however that when this happens the inductor core is seeing only very mild flux excursions, and so no significant audible noise is created. But if EMI is a particularly sensitive issue for the particular application, the user can simply opt for the slightly less efficient, though constant frequency FPWM mode.

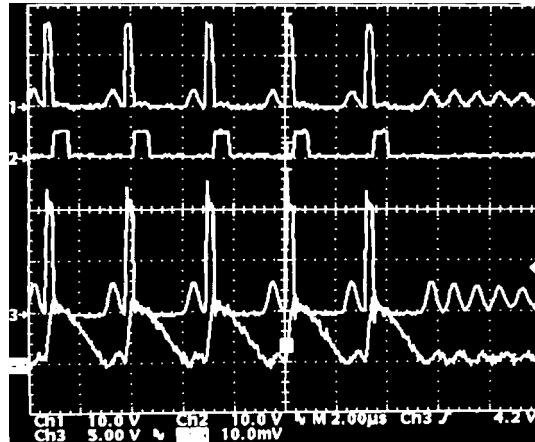

CH1: HDRV, CH2: LDRV, CH3: SW, CH4: I_L (0.2A/div)
Output 1V @ 0.04A, VIN = 10V, SKIP, L = 10 μ H, f = 300kHz

Figure 11. Normal SKIP Mode Operation at Light Loads

The SKIP mode is enabled when the FPWM pin is held low (or left floating). Note that at higher loads, and under steady state conditions (above CCM-DCM boundary), there will be absolutely no difference in the behavior of the LM2647 or the associated converter waveforms based on the voltage applied on the FPWM pin. The differences show up only at light loads.

Under startup too, since the currents are high until the output capacitors have charged up, there will be no observable difference in the shape of the ramp-up of the output rails in either SKIP mode or FPWM mode. The design has thus forced the startup waveforms to be identical irrespective of whether the FPWM mode or the SKIP mode has been selected.

The designer must realize that even at zero load condition, there is circulating current when operated in FPWM mode. This is illustrated in [Figure 12](#). Since duty cycle is the same as for conventional CCM, from $V = L \cdot \Delta I / \Delta t$ it can be seen that ΔI (or I_{pp} in [Figure 12](#)) must remain constant for any load, including zero. At zero load, the average current through the inductor is zero, so the geometric center of the sawtooth waveform (the center being always equal to load current) is along the x-axis. At critical conduction (boundary between conventional CCM and what should have been DCM were it not in FPWM mode), the load current is equal to $I_{pp}/2$. Note that excessively low values of inductance will produce much higher current ripple and this will lead to higher circulating currents and dissipation.

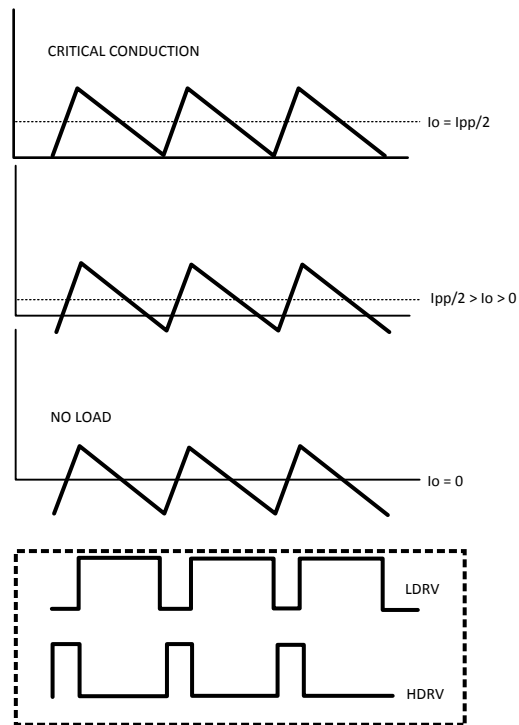
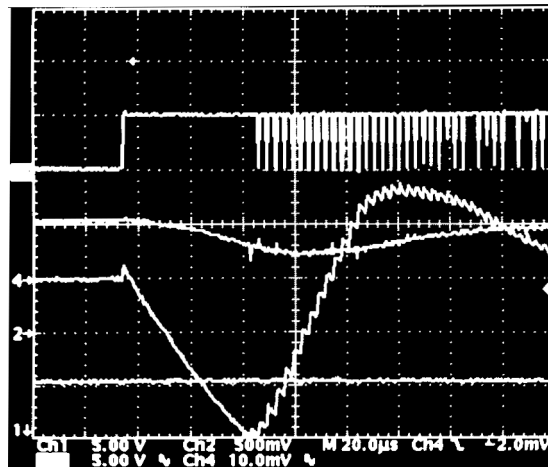

Figure 12. Inductor Current in FPWM Mode

NOTE

A common question is: can one change from FPWM to SKIP Mode ‘on the fly’? That means that the voltage on the FPWM pin would be changed while the converter is operating normally (with outputs in regulation). This is generally not recommended. The designer must realize that doing so would in essence represent a fundamental change applied to the system. The pulse widths would need to re-adjust suddenly and in the process momentary imbalances can be created. For example, there is an observed negative surge current passing from Drain to Source of the lower FET. It must be kept in mind that though the LM2647 has current limiting for current passing in the ‘positive’ direction (positive with regards to the inductor, i.e. passing from Source to Drain of the lower FET), there is no set limit for reverse currents. The amount of reverse current when the FPWM pin is toggled ‘on the fly’ can be very high. This current is determined by several factors. One key factor is the output capacitance. Large output capacitances will lead to higher peak reverse currents. The reverse swing will be worse for lighter loads because of the bigger difference between the duty cycles/average frequency in the two modes. See [Figure 13](#) for a plot of what happened in going from SKIP to FPWM mode at 0A load (worst case). The peak reverse current was as high as 3A, lasting about 0.1ms. The inductor could also saturate severely at this point if designed for light loads. In general, if the designer wants to toggle the FPWM pin while the converter is operating, both the low side FET rating and the inductor peak current rating must be closely evaluated under this condition.



CH1: PGOOD, CH2: Vo, CH3: LDRV, CH4: I_L (1A/div)
Output 1V @ 0A, VIN = 10V, L = 10µH, f = 300kHz

Figure 13. SKIP to FPWM 'On The Fly'

SOFT-START

The maximum output voltage of the error amplifier is limited during start-up by the voltage on the 0.1µF capacitor connected between the SS pin and ground. When the controller is enabled (by taking EN pin high) the following steps may occur. First the SS capacitor is discharged (if it has a pre-charge) by a 1.8 kΩ internal resistor (R_{SS_DCHG} , see [Electrical Characteristics](#)). This ensures that reset is obtained. Note that reset is said to occur only when the voltage on *both* the SS pins falls below 100mV (V_{SS_RESET} , see [Electrical Characteristics](#) table). Then a charging current source I_{SS_CHG} of 11µA is applied at this pin to bring up the voltage of the Soft-start capacitor gradually. This causes the (maximum allowable) duty cycle to increase slowly, thereby limiting the charging current into the output capacitor and also ensuring that the inductor does not saturate. The Soft-start capacitor will eventually charge up close to the 5V input rail. When EN is pulled low the Soft-start capacitor is discharged by the same 1.8 kΩ internal resistor and the controller is shutdown. Now the sequence is allowed to repeat the next time EN is taken high.

The above Soft-start sequence is actually initiated not only whenever EN is taken high, but also under a normal power-up or during recovery from a fault condition (more on this later).

As mentioned in the section [FORCED-PWM MODE AND PULSE-SKIP MODE](#) under startup, since the currents are high until the output capacitors have charged up, there will be no observable difference in the shape of the ramp-up of the output rails in either SKIP mode or FPWM mode. The design has thus forced the startup waveforms to be identical irrespective of whether the FPWM mode or the SKIP mode has been selected.

SHUTDOWN/SOFT-SHUTDOWN

When the EN pin is driven low, the LM2647 initiates shutdown by turning OFF both upper and lower FETs completely (this occurs irrespective of FPWM or SKIP modes). See [Figure 14](#) for a typical shutdown plot and note that the LDRV goes to zero (and stays there). Though not displayed, Power Good also goes low within less than 100ns of the EN pin going low (Δt_{SD} , see [Electrical Characteristics](#) table). Therefore in this case, the controller is NOT waiting for the output to actually fall out of the Power Good window before it signals Power Not Good. Note that since there is a constant current 2A load applied at the output, the stored charge on the output capacitor continues to be discharged into the load. From $\Delta V/\Delta t = i/C = 2A/330\mu F$ it can be seen that the output voltage (say 1V) will fall to zero in about 165µs, as will be observed.

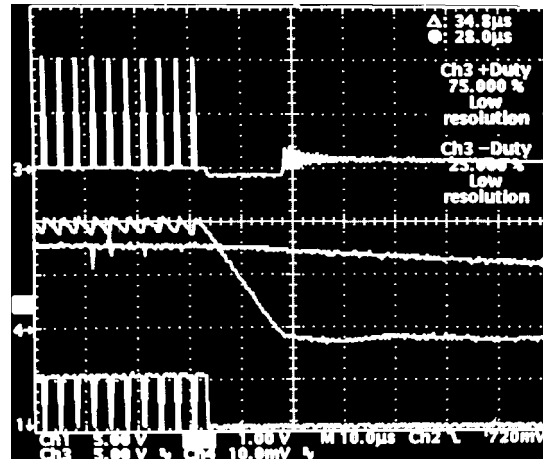

CH1: LDRV, CH2: Vo, CH3: SW, CH4: I_L (1A/div)
Output 1V @ 2A, VIN = 10V, FPWM/SKIP, L = 10µH, f = 300kHz, C_{OUT} = 330µF

Figure 14. Shutdown

But if the load is very close to zero, the only means for the output capacitor to discharge is through the resistive divider on the feedback pin (if any) and any internal bleeder resistor present. In fact there is such an internal bleeder resistor in the LM2647 and it performs Soft-shutdown by discharging the output capacitors gradually. Its value is about 20Ω and it is internally connected between the SENSE pin and ground whenever the EN pin is taken low. Note that this will be perceivable only when the external load is small, and provided a normal shutdown is being carried out. Normal shutdown as being defined here calls for the Enable pin to be the cause of the outputs being disabled. In a shutdown provoked by a fault, the situation is very different as will be explained later.

POWER GOOD/NOT GOOD SIGNALING

PGOOD is an open-Drain output pin with an external pull-up resistor connected to 5V. It goes high (non-conducting) when both the outputs are within the regulation band as determined by the Power Good window detector stage on the feedback pin (see [Figure 4](#)). PGOOD goes low (conducting) when either of the two outputs falls out of this window. This signal is referred to as Power Not Good here. A glitch filter of 7µs filters out noise, and helps prevent spurious PGOOD responses. So Power Not Good is not asserted until 7µs after either of the two outputs have fallen out of the Power Good window (see Δt_{PG_NOK} in [Electrical Characteristics](#) table). With the feedback pin voltage rising towards regulation value, there is a 20µs delay between both the outputs being in regulation and the signaling of Power Good (see Δt_{PG_OK} in [Electrical Characteristics](#)). Power Not Good is signaled within 100ns of the Enable pin being pulled low (see Δt_{SD} in [Electrical Characteristics](#) table), irrespective of the fact that the outputs could still be in regulation. The Soft-start capacitor is also then discharged as explained earlier.

VIN POWER-OFF

The LM2647 has an internal comparator that also looks at VIN. If VIN falls to about 4.5V (roughly), switching ceases. The response is slightly different under FPWM or SKIP modes, but the final result is the same. In both cases ultimately, LDRV is latched high and so the output capacitors are discharged through the lower FETs. Power Not Good has meanwhile already been signaled and a fault condition is asserted shortly thereafter.

In [Figure 15](#) and [Figure 16](#) the situation where the connection to the input DC power source is abruptly removed is shown for two cases.

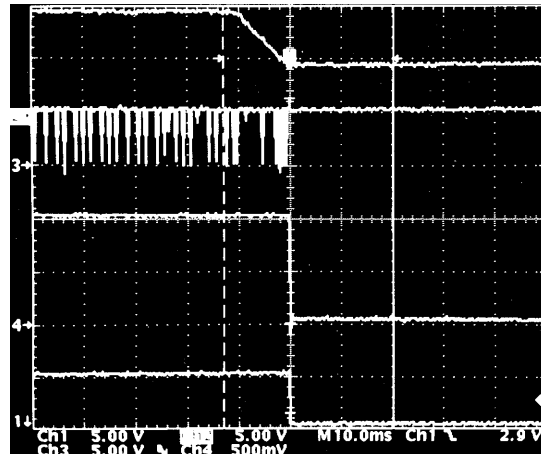

CH1: PGOOD, CH2: VIN, CH3: LDRV, CH4: Vo
Output 1V @ 0.02A, VIN = 9.75V, FPWM, L = 10 μ H, f = 300kHz, C_{OUT} = 660 μ F

Figure 15. VIN Removal in FPWM Mode

In the first case (FPWM mode, [Figure 15](#)), LDRV goes high immediately, as soon as VIN falls to about 4.5V. For the second case (SKIP mode, [Figure 16](#)), the output starts to discharge into the load resistor. Then Power Not Good is signaled. Finally, when the output falls below the Under-voltage threshold a fault condition is asserted. This is accompanied by LDRV latching high. The output then suddenly collapses just as it does for FPWM mode. Note that once VIN reaches 4.5V, it does not fall quickly thereafter. The reason is that there is no applied external voltage dragging it low (in our case as it is described), nor is there any significant consumption from the VIN rail since the converter has stopped switching.

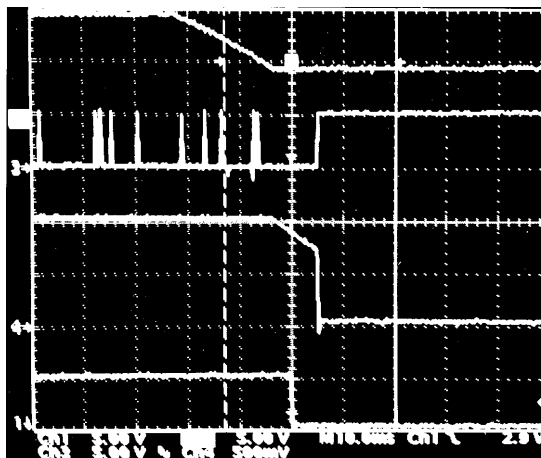

CH1: PGOOD, CH2: VIN, CH3: LDRV, CH4: Vo
Output 1V @ 0.02A, VIN = 9.75V, SKIP, L = 10 μ H, f = 300kHz, C_{OUT} = 660 μ F

Figure 16. VIN Removal in SKIP Mode

The recovery procedure from a VIN Power-off is the same as for any fault condition.

VDD POWER-OFF (UVLO)

Whenever VDD starts to fall, and drops below about 4V, LDRV goes high immediately, 'Power Not Good' is signaled and in effect a fault condition (in this case an Under-voltage lockout) is asserted. Recovery from a fault is discussed next.

FAULT AND RECOVERY

If any output falls outside the Power Good window, the response is a 'Power Not Good' signal. The FET drive signals are not affected. But under a fault condition assertion, LDRV goes high immediately turning the low side FETs ON and discharging the output capacitors. Note that the current will then invariably slew momentarily negative (passing from Drain to Source of lower FETs), before it settles down to zero.

A fault will be detected when either output falls below the Under-voltage threshold, or rises above the Over-voltage threshold. From its detection to assertion, there is a 7µs delay to help prevent spurious responses.

A fault condition is also asserted during a loss of the VIN rail or the VDD rail, though not if shutdown is achieved by use of the Enable pin.

To recover from a fault, either of the following options is available:

- a) *Enable pin is toggled: i.e. taken low (below 0.8V), then high again (2V to 5V). This must be done with VDD between 4.5V to 5V and VIN within normal range (5.5V to 28V).*
- b) *VDD is brought below 1.0V and then brought back up between 4.5V to 5V. This must be done with the Enable pin held high (2V to 5V) and VIN within normal range (5.5V to 28V).*

Recovery will initiate a Soft-start sequence (see description under section [SOFT-START](#) above).

CURRENT LIMIT AND PROTECTION

Output current limiting is achieved by sensing the negative Vds drop across the low side FET when the FET is turned on. The Current Limit Comparator (see [Figure 4](#)) monitors the voltage at the ILIM pin with 62µA (typical value) of current being sourced from the pin. The 62µA source flows through an external resistor connected between ILIM and the Drain of the lower FET. The voltage drop across the ILIM resistor is compared with the drop across the lower FET and the current limit comparator trips when the two are of the same magnitude. This determines the threshold of current limiting. For example, if excessive inductor current causes the voltage across the lower FET to exceed the voltage drop across the ILIM resistor, the ILIM pin will go negative (with respect to ground) and trip the comparator. The comparator then sets a latch which prevents the top FET from turning ON during the next PWM clock cycle. The top FET will resume switching only if the current limit comparator was not tripped in the previous switching cycle.

The Soft-start capacitor at the SS pin is discharged with a 115µA current source when an overcurrent event is in progress. Therefore if the overcurrent condition does not last long enough to cause a fault assertion, the Soft-start capacitor will charge back up (by I_{SS_CHG} , see [Electrical Characteristics](#) table), without any user intervention. The purpose of discharging the Soft-start capacitor during an overcurrent event is to eventually allow the voltage on the SS pin to fall low enough to cause additional duty cycle limiting (over and above the protection provided by the adaptive duty cycle clamp). Note that once the duty cycle starts pinching-off as a result of the progressive reduction in SS pin voltage, the output voltage will certainly start collapsing (if it hasn't done so already), and this will hasten a fault condition assertion (an Under-voltage in this case). Thereafter, a normal fault-recovery sequence will have to be initiated to cause the outputs to return to regulation.

There is a race condition in effect, between the current limit being reached and a fault being asserted (Under-voltage). It could happen that if the load current was very low before the sudden overload was applied, a fault condition could be asserted even before the current limit has been reached. See the differences between [Figure 17](#) and [Figure 18](#) to see the possibilities. Also see [Application Information](#) for a deeper understanding of current limiting discussed at a quantitative level.

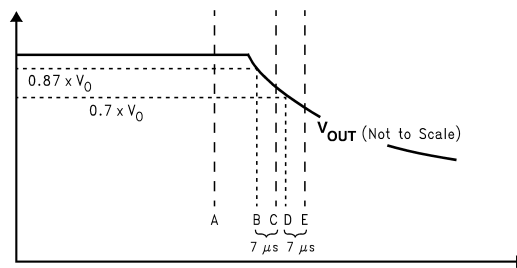
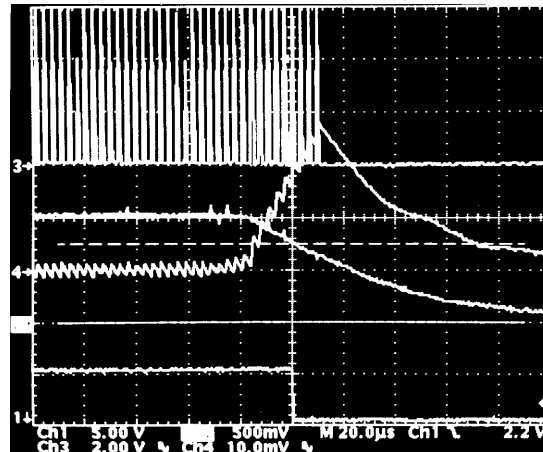

Description	Comments
A Short applied on Output	Inductor current starts to ramp up
B Power Not Good detected	Output falls to 87% set voltage
C Power Not Good asserted	'Soft-shutdown' initiated
D Output UV detected	Output falls to 70% set voltage
E Fault asserted	LDRV latches high. HDRV latches low.

CH1: PGOOD, CH2: V_o , CH3: ILIM Pin, CH4: I_L (1A/div)

Output 1V, 0.04A to Overload, $V_{IN} = 10V$, FPWM, $L = 10\mu H$, $f = 300kHz$, $RLIM = 1k$

Figure 17. Response to Severe Overload (Type A: fault threshold first)

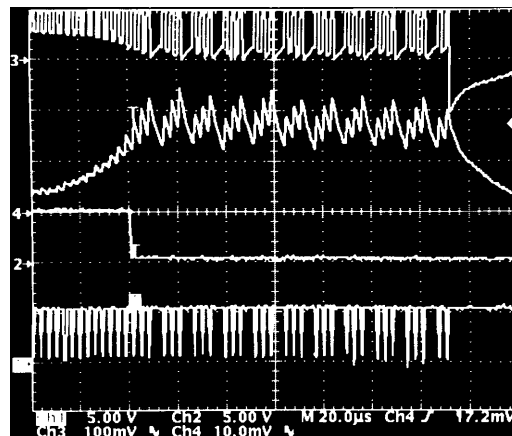

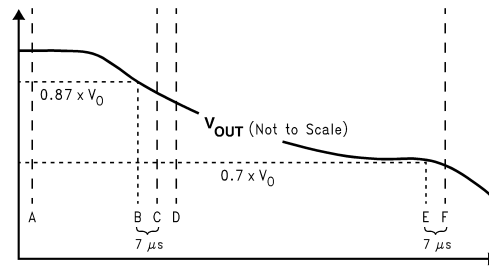

Description	Comments
A Short applied on Output	Inductor current starts to ramp up
B Power Not Good detected	Output falls to 87% set voltage
C Power Not Good asserted	'Soft-shutdown' initiated
D Current Limit reached	ON-pulses may now get skipped
E Output UV detected	Output falls to 70% set voltage
F Fault asserted	LDRV latches high. HDRV latches low.

CH1: LDRV, CH2: PGOOD, CH3: ILIM Pin, CH4: I_L (5A/div)
 Output 1V, 2A to Overload, VIN = 10V, L = 10 μ H, f = 300kHz, RLIM = 2k

Figure 18. Response to Severe Overload (Type B: current limit threshold first)

Application Information

CURRENT LIMIT RESISTOR

The timing scheme implemented in the LM2647 makes it possible for the IC to continue monitoring an overcurrent condition and to respond appropriately every cycle. This is explained as follows.

Consider the LM2647 working under normal conditions, just before an overload occurs. After the end of a given ON-pulse (say 'ton1'), the LM2647 starts sampling the current in the low-side FET. This is the OFF-duration called 'toff1' in this analysis. Therefore, if an overcurrent condition is detected during this OFF-duration 'toff1', the controller will decide to omit the next ON-pulse (which would have occurred during the duration 'ton2'). This is done by setting an internal 'overcurrent latch' which will keep HDRV low. The LDRV will now not only stay high during the present OFF-duration ('toff1') but during the duration of the next (omitted) ON-pulse ('ton2'), and then as expected also during the succeeding OFF-duration ('toff2'). But the 'overcurrent latch' is reset at the very start of the next OFF-duration 'toff2'. Therefore if the overcurrent condition persists, it can be recognized during 'toff2' and a decision to skip the next ON-pulse (duration 'ton3') can be taken. Finally, several ON-pulses may get skipped until the current in the lower FET falls below the current limit threshold.

Note that about 150ns after LDRV first goes high (start of low-side conduction), the current monitoring starts. Therefore the peak current seen by the current limit detector is almost the same as the peak inductor current.

To set the value of the current limiting resistor ('RLIM', between ILIM pin and SW pin), the function of the ILIM pin must be understood. Refer to [Figure 19](#) to see how the voltage on the ILIM pin changes as current ramps up. For this analysis note that the worst case has been taken here by using the minimum possible value of the current sourced (I_{ILIM} , see [Electrical Characteristics](#) table). Also, the maximum value of the 'hot' Rds of the lower FET should be used. For example if the chosen low-side FET is the Si4420DY from Vishay, the typical Rds at room temperature is 10m Ω (but this is not the value to be used here). The MAX is the relevant number which is 13m Ω . Now applying the thumbrule that at 100°C the Rds goes up typically 1.4 times (for 30V FETs), the Rds to be used in the actual current limit calculation is 1.4*13m Ω =18.2m Ω . Therefore using 46 μ A for I_{ILIM} (see [Electrical Characteristics](#) table) and Rds = 18.2m Ω here will provide the lowest value of current limit (considering tolerances and temperature for a chosen RLIM resistor). This current limit must obviously be higher than the actual peak current in the converter under normal operation to ensure that full rated power can be delivered under all conditions by the converter without 'inadvertently' hitting the worst case (lowest value) set current limit.

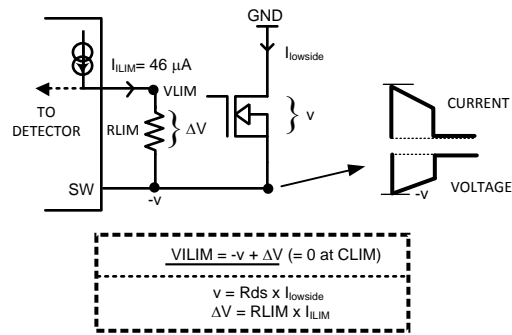

Figure 19. Understanding Current Sensing

The detector sets the overcurrent latch as soon the voltage on the ILIM pin crosses below zero. Therefore the basic design equation for calculating RLIM is:

$$\Delta V = v \quad (1)$$

(see Figure 19)

At the point where current limiting occurs (peak inductor current becomes equal to current limit) the resistor for setting the current limit can be calculated.

But what (peak) current limit value should actually be set? This depends on two factors:

a) There is a natural steady state peak current in the inductor with the converter delivering maximum rated load. This should be calculated at V_{IN_MAX} (the maximum of the input voltage range):

b) Over and above this steady state value we need to provide an 'overload margin'. This margin will depend on the step loads likely to be seen in the application and the response expected.

The equation for calculating the steady state peak current is:

$$I_{peak} = I_o \times \left(1 + \frac{r}{2}\right) \quad (2)$$

where 'r' is the current ripple ratio (refer to Application Note AN-1197 for a detailed understanding of how 'r' affects all the power components). 'r' is given by:

$$r = \frac{V_o}{I_o \times L \times f} \times (1-D) \times 10^6 \quad (3)$$

where L is in μH , f is in Hz.

Example: Let V_{IN} range from 5.5V to 28V, $V_o=5\text{V}$, $I_o=3\text{A}$, $L=10\mu\text{H}$, $f=300\text{kHz}$. What is the peak current under normal operation?

Only the highest input voltage must be used for any peak current calculation. At V_{IN_MAX} the duty cycle is $D=V_o/V_{in}=5/28=18\%$. So

$$r = \frac{5}{3 \times 10 \times 300000} \times (1-0.18) \times 10^6 = 0.45 \quad (4)$$

NOTE

In general, as discussed in AN-1197, the optimum value of 'r' is between 0.3 to 0.5. Large inductances (higher than 'optimum') may be selected if the output voltage ripple needs to be decreased but it is not desirable to achieve this by adding more (expensive?) output specialty caps.

The peak current under normal operation is

$$I_{peak} = I_o \times \left(1 + \frac{r}{2}\right) \quad (5)$$

$$I_{\text{peak}} = 3 \times \left(1 + \frac{0.45}{2}\right) = 3.7\text{A} \quad (6)$$

Conclusions: In this example the peak inductor current under normal operation is 3.7A. Usually it is necessary only to set the current limit about 20% higher than the peak value. This 'overload margin' helps greatly in handling sudden load changes. A 20% margin would have required the current limit to be set at $3.7 \times 120\% = 4.44\text{A}$ (for a steady state peak of 3.7A). Therefore RLIM would need to be

$$\text{RLIM} = \frac{R_{\text{ds}100} \times I_{\text{CLIM}}}{46\mu} \quad (7)$$

$$\text{RLIM} = \frac{18.2\text{m} \times 4.44}{46\mu} = 1.76\text{k} \quad (8)$$

A standard resistor value of 1.78k can be chosen in the example. However, a larger overload margin than the chosen 20% (say 40%) is recommended for obtaining good dynamic response if the load could suddenly change from extremely low values (zero to a few mA) right up to maximum load current. In this case, it would require $I_{\text{CLIM}} = 3.7 \times 140\% = 5.2\text{A}$, requiring RLIM to be $18.2\text{m} \times 5.2 / 46\mu = 2.05\text{k}$ (available as a standard value).

Note that excessively high current limits (large RLIM values) will generate severe stresses in the FETs during abnormal load condition (like a shorted output for example). These peak currents will be even higher if the inductor saturates sharply. The designer must evaluate the actual application for the expected and actual step loads so as to select RLIM more optimally. Then it should be decided how much overload margin is really required, and RLIM selected accordingly. The equations to do this are provided in this section, but the judgement must remain with the designer, as it depends on the specific application on hand.

Repeating the calculation for a 10 μH inductor for a 3.3V/3A rated output, and any low side equivalent FET (with the same R_{ds} as Si4420DY) we get the following requirement:

For 20% overload margin, select current limit resistor to be 1.69k

For 40% overload margin, select current limit resistor to be 1.96k

Note that if the lower FET R_{ds} is different from the one used in the example above, the current limit resistor RLIM must be recalculated according to the new R_{ds} .

For the evaluation board the selected FET was a dual pack Si4828DY. Its worst case hot R_{ds} is 24.5m Ω . Setting current limit as 5.5A, the estimated current limit resistor is $5.5 \times 24.5 / 46 = 2.93\text{k}\Omega$. A standard value of 2.94k Ω was chosen for the Bill of Materials.

INDUCTOR and OUTPUT CAPACITOR

The designer is again referred to [AN-1197](#) for the equations required here. In general, 'r' is the key parameter and once that is chosen, the inductance can be calculated. The design table in the referenced Application Note uses V_{D} as the drop across the diode in an asynchronous configuration. Also, V_{SW} is the drop across the Switch (upper FET). In the case of the LM2647 a reasonable approximation is to set $V_{\text{D}} = V_{\text{SW}} = 0$ in the design table available in [AN-1197](#). Then the table can be used easily for selection of the inductor and output capacitor. A step by step example is also provided for a general buck regulator in the Application Note [AN-1207](#).

Only in the case of the input capacitor, the situation may be different as is explained next.

INPUT CAPACITOR

In a typical single-channel buck regulator, the input capacitor provides most of the pulsed current waveform demanded by the Switch. However the DC (average) value of the current through a capacitor in steady state must be zero. Otherwise, the capacitor would start accumulating charge every cycle, and that would clearly not represent a 'steady state' by definition.

Now for the LM2647, there are two ways of calculating and meeting the input capacitance requirement. One way is to use separate input capacitors for each channel (as in the Evaluation board). The other possibility is to combine them into a single component. There are advantages and disadvantages to each approach.

By keeping separate input capacitors the possibility of interaction between the two channels is reduced, and the layout is a little more forgiving. But two components would require more board space and could also add to the cost. Though in general, there could also be a situation where the cost of a single component is equal to (or even exceeds) the combined cost of two separate capacitors. The reason cost can be surely reduced when using one input capacitor in the LM2647 is because the two channels run 180° out of phase (interleaved switching). It can be shown that this dramatically reduces the ripple current requirement at the input. See Figure 20 for typical waveforms to understand how this happens. Remember that ‘frequency’ does not (directly) enter into any computations of RMS values, so the use of interleaved switching is clearly going to produce a lower RMS value as can be guessed by eyeballing the waveforms shown in Figure 20.

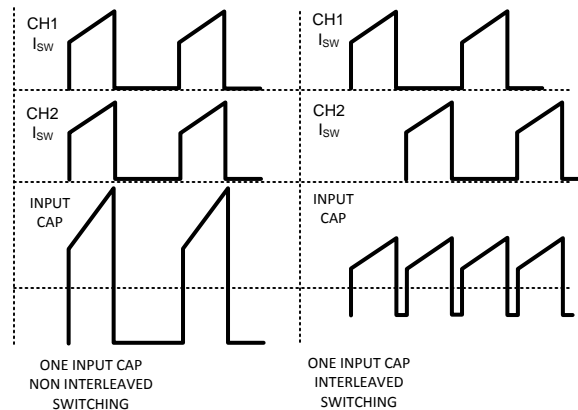

Figure 20. Switch and Input Capacitor Currents

The case of a single input capacitor supplying two channels running out of phase is now discussed in detail and it shows how to formally calculate the input RMS current capability required. The example represents a very general case in terms of the output voltages simply to highlight the various possible applications of the LM2647 other than its primary intended application. One of the most important questions to answer here is: what input voltage really gives the worst possible (highest) input RMS current? This information is required to size the capacitor correctly.

Example: Consider two channels running at 5V@3A and 3.3V@3A. What is the worst case input capacitor RMS current if the input varies from 10V to 28V?

Step1: Call the output with the higher voltage as Vo1 and the other as Vo2. Then find the ratio ‘y’ as shown below

$$y = \frac{Vo2}{Vo1} = \frac{3.3}{5} = 0.66 \tag{9}$$

y is clearly going to be equal to or less than 1 by definition (since Vo2 ≤ Vo1). This step is required for using the equation presented in the next step.

Step2: The equation for the input current has been derived and it reveals that the worst-case occurs when the duty cycle of the first channel is

$$D1 = \frac{Io1^2 + (y \times Io2^2)}{2 \times \{Io1 + (Io2 \times y)\}^2} \tag{10}$$

where ‘y’ has been defined in Step 1. So

$$D1 = \frac{3^2 + (0.66 \times 3^2)}{2 \times \{3 + (3 \times 0.66)\}^2} = 0.3 \tag{11}$$

Therefore the appropriate input voltage to calculate the worst case RMS input current is

$$VIN = \frac{Vo1}{D1} = \frac{5}{0.3} = 16.7V \tag{12}$$

Step3: Calculate the duty cycle of the other channel when this happens

$$D2 = \frac{Vo2}{V_{IN}} = 0.2 \quad (13)$$

Step4: Calculate input capacitor RMS current by using the known equation

$$I_{IN}^2 = (Io1^2 \cdot D1) + (Io2^2 \cdot D2) - [Io1 \cdot D1 + Io2 \cdot D2]^2 \quad (14)$$

$$I_{IN}^2 = (3^2 \cdot 0.3) + (3^2 \cdot 0.2) - [(3 \cdot 0.3) + (3 \cdot 0.2)]^2 \quad (15)$$

Solving

$$I_{IN} = 1.5A \quad (16)$$

Step5: But what is really the worst case??

It may have simply concluded at this point that "the rating of the input capacitor must be greater or equal than 1.5A, otherwise the life/reliability of the capacitor may be affected severely etc.". And that is true but only under the single-point load conditions used for the calculation. It will now be seen that the worst case may still have gone unrecognized. What if maximum load currents are not being drawn simultaneously as was assumed in our example? It can be shown that the capacitor could actually see higher currents than calculated in Step 4.

Suppose one channel was completely unloaded. So in effect there is only a single output of 5V@3A. The equation for the RMS current through the input capacitor is then

$$I_{IN} = Io\sqrt{D(1-D)} \quad (17)$$

The function $D(1-D)$ has a maxima at $D = 0.5$. This would correspond to an input voltage of $5V/0.5 = 10V$. And the input capacitor current at this worst case input voltage would be

$$I_{IN} = 3\sqrt{0.5(1-0.5)} = 3 \times 0.5 = 1.5A \quad (18)$$

It is just a coincidence in this application that in both cases (above and at the end of Step 4) we have calculated the same RMS current rating for the capacitor. In general, Step 4 can certainly yield smaller values than those for a single channel, and this may mislead us into an improper selection of the input capacitor. It must be remembered that Step 4 is not necessarily the worst case. We must always take the higher of the two values so calculated.

Incidentally, the above method for a single channel is also the method to be used to calculate the capacitor rating when the LM2647 is formally used for single channel operation, or if both channels are being used but separate input capacitors are being allocated for each channel.

In all cases the input capacitors must be positioned physically close to their respective stages. But if separate input capacitors are being used for each channel, the input traces to the two inputs must be long and thin so as to introduce a measure of high frequency decoupling between the now separated stages.

The designer may ask, what is the use of interleaved switching if the result of the interleaved calculation in Step 4 may not even be used in our particular example? Interleaved switching certainly reduces cost because if the calculation had been carried out for two non-interleaved channels (switching in phase), both delivering maximum load, the capacitor RMS current would have been much higher.

Note that the equations used in the above sections apply only if the duty cycles of both channels are less than or equal to 50% (and there is therefore no overlap in the current waveforms). The equations for overlapping waveforms are out of scope here.

MOSFETS

The selection of the MOSFETS should be done carefully to maximize both efficiency and reliability together. There is a different set of criteria for selecting the upper FET and lower FET. It will also be seen that using very fast FETs without deliberate thought, may seem to improve efficiency dramatically on one prototype board but can impair efficiency on another apparently 'identical' board, specially at light loads. Therefore, the quest for improved efficiency must be weighed against the possible penalty for doing this without deeper understanding of the nuances of synchronous switching buck stages in general. The criteria for selection are briefly:

a) The upper FET is chosen basically for high switching speed because in a typical synchronous buck regulator only the upper FET sees the V-I crossover losses (at turn-ON and at turn-OFF). So to maximize efficiency, high switching speed is certainly needed in this position. This FET position has typically very low conduction losses, especially in a power supply for mobile applications since the duty cycle is very low. So the R_{ds} is not of much direct concern here. A possible choice of FET for the upper position on the Evaluation board is the Si4800DY from Vishay (www.vishay.com). The threshold voltage (MIN value) of a FET in this position can be 0.8V but 1.0V is preferable. Note however that if the upper FET is chosen so that it switches too fast, it can induce a shoot-through (called a CdV/dt turn-on of the lower FET) whenever the upper FET turns on hard. Therefore, Q_G of the upper FET should not be much less than 8nC.

b) The lower FET sees no V-I crossover loss in principle (under most situations). Also, since it can conduct for the complete OFF-time, its R_{ds} becomes important, especially at low duty cycles. This FET is therefore chosen basically for its low R_{ds}, not necessarily speed. A high C_{OSS} for this FET position also helps, by reducing the possibility of CdV/dt turn-on of this FET, by snubbing the rising edge of voltage applied on the lower FET when the upper FET turns ON. Note that too high a C_{OSS} value will degrade efficiency. An acceptable compromise figure for C_{OSS} of the lower FET is 350-800pF. A possible choice of FET for this position is the Si4420DY from Vishay. The C_{OSS} of this FET is about 700pF at 24V. The threshold voltage for the lower FET position must also be 1V or slightly higher. Too high a threshold will prevent the FET from turning ON fully, and too low a value will increase the likelihood of a CdV/dt turn-on. Also note that one of the factors which can provoke a spurious turn-on is layout. In particular, the source lead/trace of a given FET must be kept short and the copper area around it large to reduce inductive spikes during transitions. Gate trace lengths must also be kept short.

Note that the threshold voltage of a FET should have both MIN and MAX limits as per its datasheet. Since it is important that the FET turn on fully, ensure that the threshold voltage is ensured to be below 3V. Contact the FET vendor if necessary. If the threshold voltage is too high, foldback might result upon hitting current limit. This will result in failure of the output to recover after an overload condition.

EFFICIENCY ESTIMATE

A sample calculation follows based on the low cost FETs used on the Evaluation Board. The device is the Si4828DY from Vishay.

The extension '_u' stands for the upper FET (half Si4828DY), and '_l' for the lower FET (half Si4828DY). The general equation is first stated and then the numerical result is quoted (in bold). The case is for V_{IN}=20V, V_o=5V, I_o=3A. The frequency is set to 300kHz. Note that efficiency estimates are usually based on typical values. Therefore, in the calculations below the typical value of the gate charge Q_G is used. For the Si4828DY the typical values as declared in its datasheet (available at the time of writing this section) are Q_G(upper) = 8nC, Q_G(lower) = 23nC, R_{ds}(upper) = 24mΩ, R_{ds}(lower) = 14.5mΩ

FET Conduction losses

$$P_{cond_u} = I_o^2 \times r_{ds_u} \times \frac{V_o}{V_{IN}} \quad (19)$$

$$P_{cond_u} = \mathbf{54mW}$$

$$P_{cond_l} = I_o^2 \times r_{ds_l} \times \left(1 - \frac{V_o}{V_{IN}}\right) \quad (20)$$

$$P_{cond_l} = \mathbf{98mW}$$

FET Switching Losses

The transition times must first be determined. A simplified equation available in related literature is:

$$t_r = t_f \approx 4.6 \times R_p \times \frac{Q_G}{V_p} \quad (21)$$

This equation is applied to our case by setting the pulse amplitude V_p to 5V. Suppose the output impedances of the IC are (in ohms):

$$R_{pon_u} = 7$$

$$R_{poff_u} = 2$$

$$R_{pon_l} = 7$$

$$R_{poff_l} = 1$$

Therefore transition times are

$$t_{on_u} = 4.6 \times R_{pon_u} \times \frac{Q_{g_u}}{V_p} \quad (22)$$

$$t_{on_u} = 51.5\text{ns}$$

$$t_{off_u} = 4.6 \times R_{poff_u} \times \frac{Q_{g_u}}{V_p} \quad (23)$$

$$t_{off_u} = 15\text{ns}$$

$$t_{on_l} = 4.6 \times R_{pon_l} \times \frac{Q_{g_l}}{V_p} \quad (24)$$

$$t_{on_l} = 148\text{ns}$$

$$t_{off_l} = 4.6 \times R_{poff_l} \times \frac{Q_{g_l}}{V_p} \quad (25)$$

$$t_{off_l} = 21\text{ns}$$

The switching loss for any V-I crossover when driving an inductive load is in general

$$P_{cross} = 1/2 \times V \times I \times t_{cross} \times \text{freq}$$

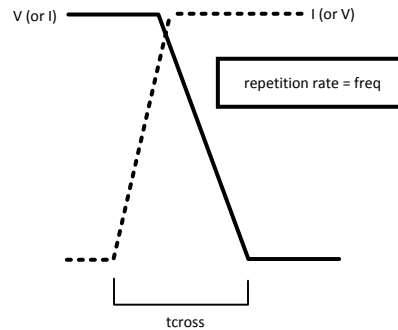

Figure 21. Crossover (turn-on or turn-off)

The V-I crossover losses (exist only in upper FET) are:

$$P_{swon_u} = 1/2 \cdot V_{IN} \cdot I_o \cdot f \cdot t_{on_u} \quad (26)$$

$$P_{swon_u} = 464\text{mW}$$

$$P_{swoff_u} = 1/2 \cdot V_{IN} \cdot I_o \cdot f \cdot t_{off_u} \quad (27)$$

$$P_{swoff_u} = 132\text{mW}$$

There is another loss term associated with charging C_{OSS} every cycle, then dumping it into the FET before the next charge cycle. This applies to both upper and lower FETs.

$$P_{coss_u} = 1/2 \cdot C_{OSS_u} \cdot V_{IN}^2 \cdot f \quad (28)$$

$$P_{coss_l} = 1/2 \cdot C_{OSS_l} \cdot V_{IN}^2 \cdot f \quad (29)$$

From the datasheets of the chosen FETs, 'Coss' are respectively about:

$$C_{OSS_u} = 250\text{pF}$$

$$C_{OSS_l} = 500\text{pF}$$

So

$$P_{coss_u} = 15\text{mW}$$

$$P_{coss_l} = 30\text{mW}$$

Summing up,

$$P_{sw_u} = 464 + 132 + 15 = 611 \text{ mW}$$

$$P_{sw_l} = 30 \text{ mW}$$

Controller Losses

In addition to the losses in the FETs, there is another loss term associated with the switching, and this is dissipated in the controller. The LM2647 has to pump in current pulses at each transition to turn-ON or turn-OFF the FETs. Several simplified or more complicated equations exist for calculating this, but this is most easily deduced by simply turning to the measured consumption (see [Electrical Characteristics](#) table). The current into the V5 pin is I_{Q_V5} and reflects the driver consumption. This can be as high as 1.5mA (measured at 300kHz). Let us also include the current into the control sections (VDD pin), which can be as high as 4mA. The total controller consumption is therefore

$$P_{IC} = (I_{Q_V5} + I_{Q_VDD}) \times 5 \quad (30)$$

$$P_{IC} = 28 \text{ mW}$$

Inductor Losses

The DC resistance ('DCR') of the chosen inductor is typically is 26mΩ. The DC loss is therefore $DCR \cdot I_o^2$. The core losses typically add 10% more to this. Therefore our estimate of total inductor loss is

$$P_{ind} = 1.1 \times (DCR \times I_o^2) \quad (31)$$

$$P_{ind} = 257 \text{ mW}$$

Capacitor Losses

The output capacitor of a typical buck regulator has very low ripple current going through it. So its loss term can be ignored. The input capacitor however provides the sharp pulses of current for the Switch, and therefore the RMS current through it can be fairly high. But the dissipation can still be negligible if the ESR is very low. This is the situation if the input capacitors are monolithic ceramic capacitors as in the Evaluation board (if Tantalum or Aluminum electrolytic capacitors are used at the input, their dissipation must be accounted for here). The final efficiency/loss terms are provided in [Table 1](#).

Table 1. Losses and Efficiency

	Upper	Lower
Pcond (mW)	54	98
Psw (mW)	611	30
PFET (mW)	665	128
P _{IC} (mW)	28	
Pind (mW)	257	
Ptotal (mW)	1078	
Pout (=VoxIo) (mW)	15000	
	93%	
$Eff = \frac{P_{OUT}}{P_{OUT} + P_{TOTAL}}$		

Typical efficiency curves for different input voltages are available under Typical Performance Characteristics.

LAYOUT GUIDELINES

For a deeper understanding of Buck converters and the 'critical traces' please see Application Note [AN-1229](#).

[Figure 22](#) is based on such an understanding of the critical sections and also the pin functions of the LM2647. Refer to the [Typical Application](#) circuit and the LM2647 TSSOP to understand the layout suggestions more thoroughly. The components shown in [Figure 22](#) are most critical and must be placed close to the device and connected onto a ground island on the component side. Several vias can then connect to the ground plane at the locations indicated. The FETs are positioned close to the controller and are also very close to each other to minimize inductances.

After the critical components are placed, the resistor to the frequency adjust pin (R19) must also be placed close to the IC connecting to SGND. This will reduce noise pickup and jitter.

The feedback trace can also pick up noise and it must be routed away from sources of noise/EMI, particularly the FETs and inductors.

Enough copper area must be left around the FETs for thermal dissipation. More details on this are also provided in [AN-1229](#).

Note that the current limit detector circuit compares the voltage on the ILIM pin with respect to the PGND pin. Therefore, if the power ground is noisy it can lead to erroneous triggering of the current limit detector. This will manifest itself as an inability to meet the load requirement despite oversizing the current limit resistor. It can also lead to failure of the output to recover after encountering an overload condition. Therefore, it is strongly recommended that a solid ground plane be created as the first internal plane right below the component side. Several vias should be generously placed to connect the ground nodes of the component layer to this ground plane.

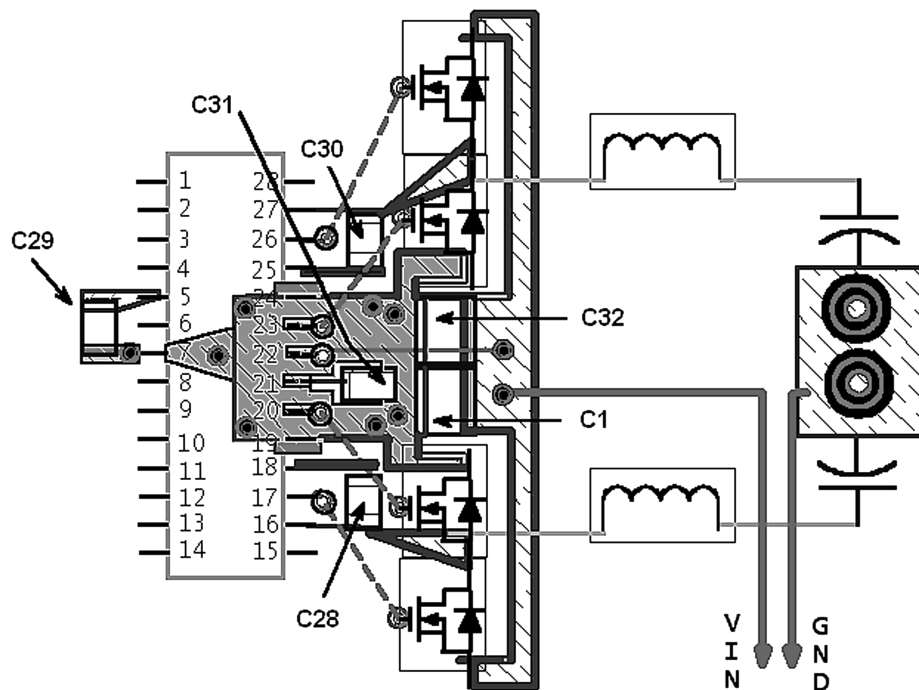

Figure 22. Critical Component placement (TSSOP)

SETTING OUTPUT VOLTAGE

From the Typical Application circuit on Page 1, it can be seen that R15 and R16 are used to set V_{O2} whereas R21 and R22 set V_{O1} . For either channel, calling the upper resistor (connected to one end of the droop resistor) R_U and the lower resistor (connected to ground) R_L the following equation is applicable.

$$V_O = \frac{R_U + R_L}{R_L} \times V_{FB} \tag{32}$$

Therefore from the Bill of Material:

For **channel #1** ($V_{O1} = 5V$),

$R_U = R21 = 43.2k$

$R_L = R22 = 5.9k$

For **channel #1** ($V_{O2} = 3.3V$),

$R_U = R15 = 43.2k$

$R_L = R16 = 9.53k$

So

$$V_{O1} = \frac{(43.2 + 5.9) \times 0.6}{5.9} = 4.99V \tag{33}$$

$$V_{O2} = \frac{(43.2 + 9.53) \times 0.6}{9.53} = 3.32V \tag{34}$$

This is as per the requirement of the primary end-application. Other output voltage values are possible by adjusting the resistor ratios (but note that there are maximum duty cycle constraints as stated in [Electrical Characteristics](#) table) which will limit the range of output voltages achievable. Note that the upper resistor is involved in fixing the gain of the error amplifier, and therefore its value has been set to an 'optimum' value of 43.2k for both channels. This value helps in achieving good step response and ensuring stability. Therefore, in general, only the lower resistor should be adjusted. However the more experienced designer can judiciously use the open-loop gain information provided in the next section, to change both upper and lower resistor values if required.

MODULATOR GAIN/COMPENSATION

The modulator gain is plotted out for various typical values of components in Typical Performance characteristics. The curves were based on the following information. The plant/modulator gain 'G' is:

$$G = \frac{1}{V_{RAMP}} \times \frac{R_o \times V_{in} \times (s \times C \times esr + 1)}{A_1 \times s^2 + A_2 \times s + A_3}$$

where

- R_o is the load resistance
- $s = j\omega$
- $A_1 = LC \times (R_o + esr)$
- $A_2 = \{L + R_p C (R_o + esr) + R_o \times esr \times C\}$
- $A_3 = R_o + R_p$

(35)

Here esr is the Equivalent Series Resistance of the output capacitor, R_o is the load resistance, C is the output capacitance, L is the inductance, and R_p is the resistance of the power stage ($R_{ds} + DCR$ etc, typically about 40mΩ). V_{RAMP} is about 1.6V for the LM2647. The unity gain bandwidth of the error amplifier is taken as 6.5MHz.

Let us assume Type 3 compensation [Figure 23](#).

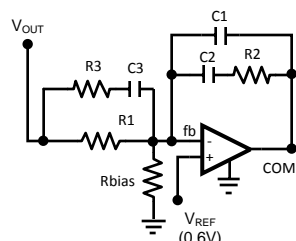

Figure 23. Type 3 Compensation

The design procedure is summarized in [Summary of Compensation Design Procedure](#).

Summary of Compensation Design Procedure

Table 2.

	fp1	fz1	fz2	fp2	fp3
Type 3	(C1)	R2, C2	R1sR3, C3	R2, C1sC2	C3, R3

Table 3.

C1	C2	C3	R2	R3
$\frac{f_z}{R1 \times A \times fp3}$	$\frac{1}{R1 \times A} - C1$	$\frac{1}{2\pi \times R1} \left(\frac{1}{fz2} - \frac{1}{fp2} \right)$	$\frac{1}{2\pi \times C2 \times fz1}$	$\frac{1}{2\pi \times C3 \times fp2}$

Table 4.

fp1	fz1	fz2	fp2	fp3
(0)	fdp	fdb	fesr	fsw/2

A short explanation on [Table 3](#) follows. For example from the table it can be seen that the second zero is created by the series combination of R1 and R3 resonating with C3. So the frequency of this zero is at $1/2\pi(R1+R3)*C3$. The solution for calculating the component values follows. For example, C3 is set as

$$C3 = \frac{1}{2\pi \times R1} \left(\frac{1}{fz2} - \frac{1}{fp2} \right) \quad (36)$$

But where should the designer position the poles and zeroes of the error amplifier, taking into account the modulator gain, so as to achieve good closed loop characteristics? A typical scenario is also provided in [Table 4](#). For example it suggests that both the first and second zeroes should be positioned at the point where double pole (fdb) of the output LC filter is. This double pole is known to occur at about.

$$fdp = \frac{1}{2\pi\sqrt{LC}} \quad (37)$$

Similarly, the esr zero occurs at fesr which is at

$$fesr = \frac{1}{2\pi \times esr \times C} \quad (38)$$

where C is the output capacitance

Thus all the components can be calculated easily

EVALUATION BOARD DETAILS

The Bill of Materials is now provided for the LM2647 Evaluation board. The schematic is the [Typical Application](#) circuit. See [LAYOUT GUIDELINES](#) for more guidance on preferred layout practices and also refer to Application Note [AN-1229](#). Note that a dual FET pack has been chosen for the Evaluation Board.

The Evaluation board has two outputs $V_{O1} = 5V$ and $V_{O2} = 3.3V$ as discussed under [SETTING OUTPUT VOLTAGE](#) section. The rated load on each output is 2A continuous, and 3A peak. A minimum load of 0.1mA should be maintained on each output in SKIP mode, to ensure regulation.

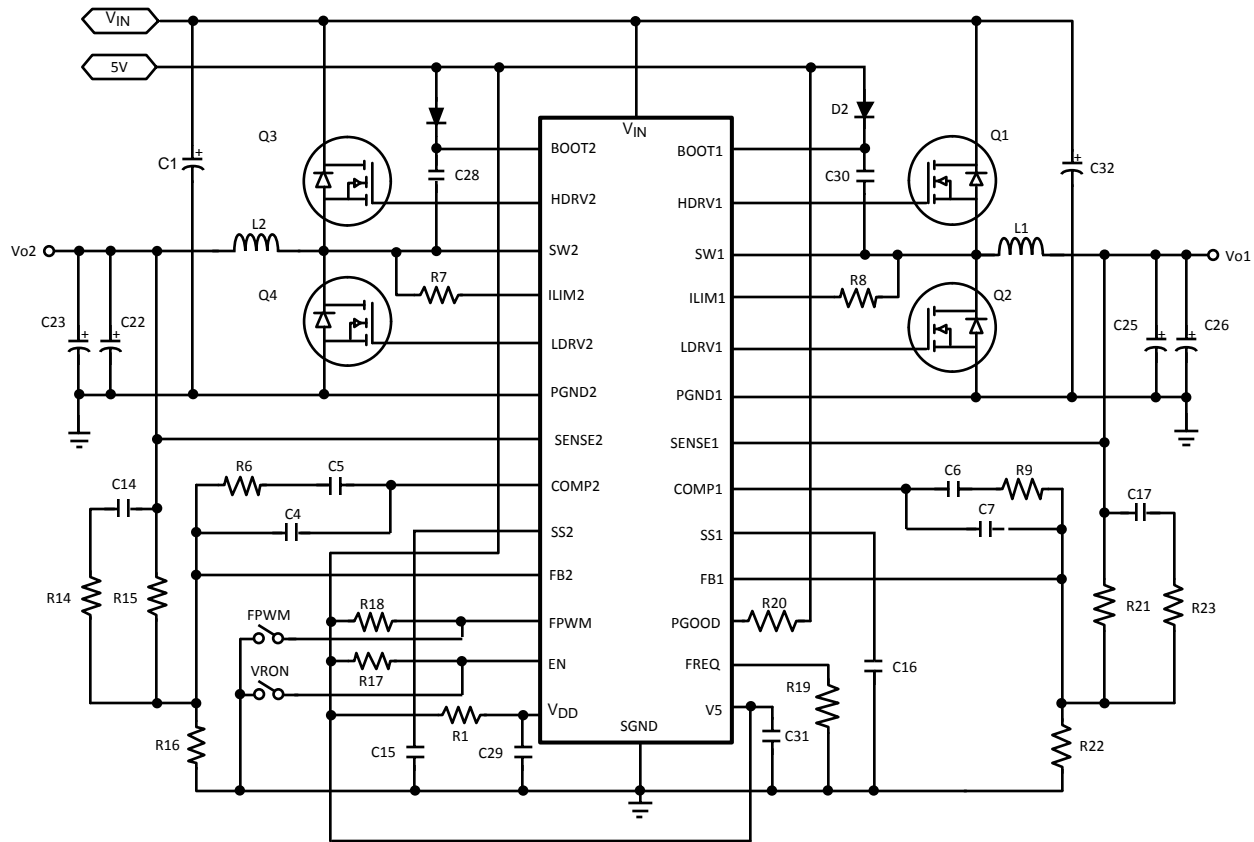

Figure 24. Typical Application (Expanded View)

Table 5. Bill of Materials for Figure 24

Designator	Function	Description	Type	Vendor
C1	Cin (Ch #2)*	10 μ F, 25V, X7R	1812	TDK
C4	Comp cap (across RC, Ch #2)	15pF, 6.3V, X7R	1206	Vishay
C5	Comp cap (series with R, Ch #2)	680pF, 6.3V, X7R	1206	Vishay
C6	Comp cap (series with R, Ch #1)	680pF, 6.3V, X7R	1206	Vishay
C7	Comp cap (across RC, Ch #1)	15pF, 6.3V, X7R	1206	Vishay
C14	Cff (Ch #2)	680pF, 6.3V, X7R	1206	Vishay
C15	Soft-start cap (Ch #2)	0.1 μ F, 6.3V/25V, X7R	1206	Vishay
C16	Soft-start cap (Ch #1)	0.1 μ F, 6.3V/25V, X7R	1206	Vishay
C17	Cff (Ch #1)	680pF, 6.3V, X7R	1206	Vishay
C22	Cout1 (Ch #2) (optional)	330 μ F, 10V, Ta	593 Series	Vishay
C23	Cout2 (Ch #2)	330 μ F, 10V, Ta	593 Series	Vishay
C25	Cout1 (Ch #1)	330 μ F, 10V, Ta	593 Series	Vishay
C26	Cout2 (Ch #1) (optional)	330 μ F, 10V, Ta	593 Series	Vishay
C28	Cboot (Ch #2)	0.1 μ F, 6.3V, X7R	1206	Vishay
C29	V5 decoupling	0.1 μ F, 6.3V, X7R	1206	Vishay
C30	Cboot (Ch #1)	0.1 μ F, 6.3V, X7R	1206	Vishay
C31	VDD decoupling	2.2 μ F, 25V, X7R	1206	Vishay
C32	Cin (Ch #1)*	10 μ F, 25V, X7R	1812	TDK
R1	V5 to VDD series pass	10 Ω , 5%	1812	Vishay

Table 5. Bill of Materials for Figure 24 (continued)

Designator	Function	Description	Type	Vendor
R6	Comp res (series with C, Ch #2)	57.6k, 1%	1206	Vishay
R7	RLIM (Ch #2)	2.94k, 1%	1206	Vishay
R8	RLIM (Ch #1)	2.94k, 1%	1206	Vishay
R9	Comp res (series with C, Ch #1)	57.6k, 1%	1206	Vishay
R14	Rff (Ch #2)	12.7k, 1%	1206	Vishay
R15	Res divider, upper (Ch #2)	43.2k, 1%	1206	Vishay
R16	Res divider, lower (Ch #2)	9.53k, 1%	1206	Vishay
R17	Enable pullup	12.7k, 1%	1206	Vishay
R18	FPWM pullup	12.7k, 1%	1206	Vishay
R19	Freq Adjust	22.1k, 1%	1206	Vishay
R20	PGOOD pullup	12.7k, 1%	1206	Vishay
R21	Res divider, upper (Ch #1)	43.2k, 1%	1206	Vishay
R22	Res divider, lower (Ch #1)	5.9k, 1%	1206	Vishay
R23	Rff (Ch #1)	12.7k, 1%	1206	Vishay
L1	Inductor (Ch #1)	10µH,4.4A	CDRH104R	Sumida
L2	Inductor (Ch #2)	10µH,4.4A	CDRH104R	Sumida
D1	Bootstrap diode (Ch #2)	BAT54LT1	SOT-23	Onsemi
D2	Bootstrap diode (Ch #1)	BAT54LT1	SOT-23	Onsemi
Q1	Upper FET (Ch #1)	Si4828DY (half)	SO-8	Vishay
Q2	Lower FET (Ch #1)	Si4828DY (half)	SO-8	Vishay
Q3	Upper FET (Ch #2)	Si4828DY (half)	SO-8	Vishay
Q4	Lower FET (Ch #2)	Si4828DY (half)	SO-8	Vishay
U1	Controller	LM2647	TSSOP	TI
S1	Dual SPDT switch (see Typical Application)	CKN1276-ND	DIP	Grayhill

PCB Layout Diagrams

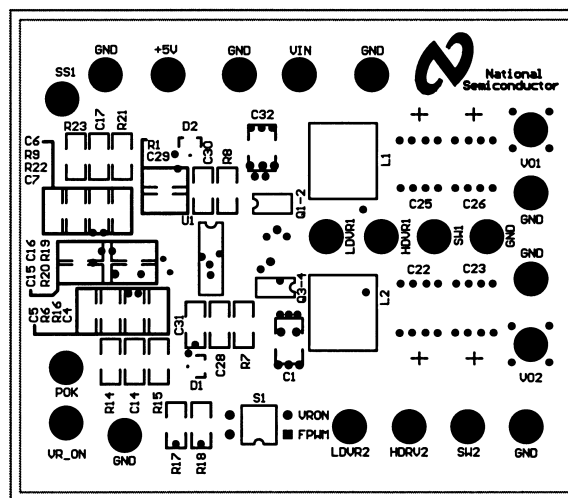

Figure 25. Top Overlay

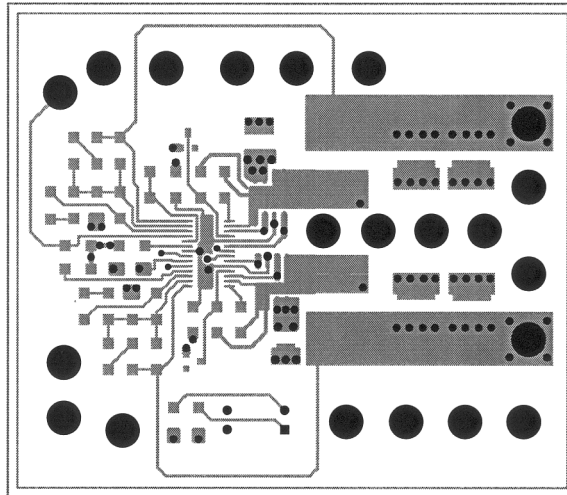

Figure 26. Top Layer

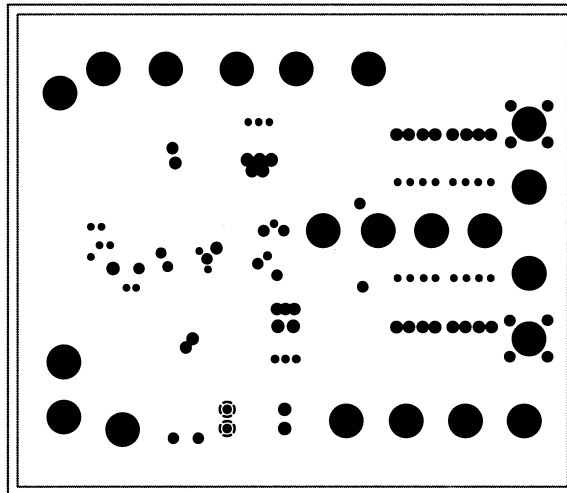

Figure 27. Internal Plane 1 (GND)

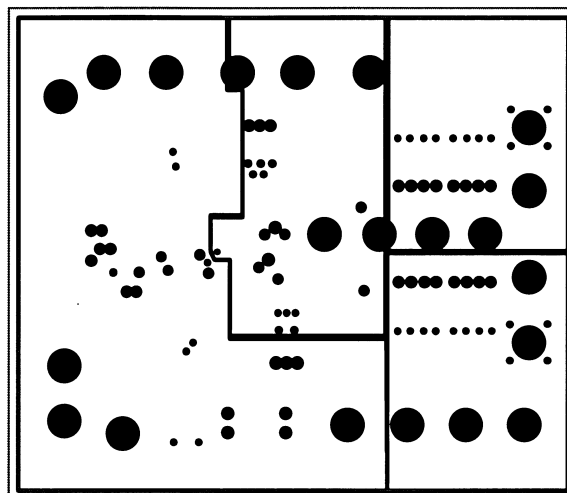

Figure 28. Internal Plane 2

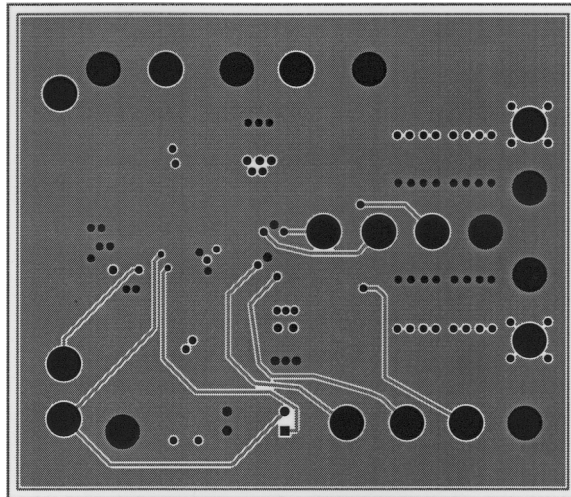

Figure 29. Bottom Layer

REVISION HISTORY

Changes from Revision E (April 2013) to Revision F	Page
<hr/> <ul style="list-style-type: none">• Changed layout of National Data Sheet to TI format	<hr/> 34

PACKAGING INFORMATION

Orderable Device	Status (1)	Package Type	Package Drawing	Pins	Package Qty	Eco Plan (2)	Lead/Ball Finish (6)	MSL Peak Temp (3)	Op Temp (°C)	Device Marking (4/5)	Samples
LM2647LQ/NOPB	ACTIVE	WQFN	NJB	28	1000	Green (RoHS & no Sb/Br)	CU SN	Level-1-260C-UNLIM	-5 to 125	LM2647	Samples
LM2647LQX/NOPB	ACTIVE	WQFN	NJB	28	4500	Green (RoHS & no Sb/Br)	CU SN	Level-1-260C-UNLIM	-5 to 125	LM2647	Samples
LM2647MTC/NOPB	ACTIVE	TSSOP	PW	28	48	Green (RoHS & no Sb/Br)	SN CU SN	Level-3-260C-168 HR	-5 to 125	LM2647 MTC	Samples
LM2647MTCX/NOPB	ACTIVE	TSSOP	PW	28	2500	Green (RoHS & no Sb/Br)	SN CU SN	Level-3-260C-168 HR	-5 to 125	LM2647 MTC	Samples

(1) The marketing status values are defined as follows:

ACTIVE: Product device recommended for new designs.

LIFEBUY: TI has announced that the device will be discontinued, and a lifetime-buy period is in effect.

NRND: Not recommended for new designs. Device is in production to support existing customers, but TI does not recommend using this part in a new design.

PREVIEW: Device has been announced but is not in production. Samples may or may not be available.

OBSELETE: TI has discontinued the production of the device.

(2) Eco Plan - The planned eco-friendly classification: Pb-Free (RoHS), Pb-Free (RoHS Exempt), or Green (RoHS & no Sb/Br) - please check <http://www.ti.com/productcontent> for the latest availability information and additional product content details.

TBD: The Pb-Free/Green conversion plan has not been defined.

Pb-Free (RoHS): TI's terms "Lead-Free" or "Pb-Free" mean semiconductor products that are compatible with the current RoHS requirements for all 6 substances, including the requirement that lead not exceed 0.1% by weight in homogeneous materials. Where designed to be soldered at high temperatures, TI Pb-Free products are suitable for use in specified lead-free processes.

Pb-Free (RoHS Exempt): This component has a RoHS exemption for either 1) lead-based flip-chip solder bumps used between the die and package, or 2) lead-based die adhesive used between the die and leadframe. The component is otherwise considered Pb-Free (RoHS compatible) as defined above.

Green (RoHS & no Sb/Br): TI defines "Green" to mean Pb-Free (RoHS compatible), and free of Bromine (Br) and Antimony (Sb) based flame retardants (Br or Sb do not exceed 0.1% by weight in homogeneous material)

(3) MSL, Peak Temp. - The Moisture Sensitivity Level rating according to the JEDEC industry standard classifications, and peak solder temperature.

(4) There may be additional marking, which relates to the logo, the lot trace code information, or the environmental category on the device.

(5) Multiple Device Markings will be inside parentheses. Only one Device Marking contained in parentheses and separated by a "~" will appear on a device. If a line is indented then it is a continuation of the previous line and the two combined represent the entire Device Marking for that device.

(6) Lead/Ball Finish - Orderable Devices may have multiple material finish options. Finish options are separated by a vertical ruled line. Lead/Ball Finish values may wrap to two lines if the finish value exceeds the maximum column width.

Important Information and Disclaimer: The information provided on this page represents TI's knowledge and belief as of the date that it is provided. TI bases its knowledge and belief on information provided by third parties, and makes no representation or warranty as to the accuracy of such information. Efforts are underway to better integrate information from third parties. TI has taken and continues to take reasonable steps to provide representative and accurate information but may not have conducted destructive testing or chemical analysis on incoming materials and chemicals. TI and TI suppliers consider certain information to be proprietary, and thus CAS numbers and other limited information may not be available for release.

In no event shall TI's liability arising out of such information exceed the total purchase price of the TI part(s) at issue in this document sold by TI to Customer on an annual basis.

TAPE AND REEL INFORMATION

QUADRANT ASSIGNMENTS FOR PIN 1 ORIENTATION IN TAPE

*All dimensions are nominal

Device	Package Type	Package Drawing	Pins	SPQ	Reel Diameter (mm)	Reel Width W1 (mm)	A0 (mm)	B0 (mm)	K0 (mm)	P1 (mm)	W (mm)	Pin1 Quadrant
LM2647LQ/NOPB	WQFN	NJB	28	1000	178.0	12.4	5.3	5.3	1.3	8.0	12.0	Q1
LM2647LQX/NOPB	WQFN	NJB	28	4500	330.0	12.4	5.3	5.3	1.3	8.0	12.0	Q1
LM2647MTCX/NOPB	TSSOP	PW	28	2500	330.0	16.4	6.8	10.2	1.6	8.0	16.0	Q1

TAPE AND REEL BOX DIMENSIONS



*All dimensions are nominal

Device	Package Type	Package Drawing	Pins	SPQ	Length (mm)	Width (mm)	Height (mm)
LM2647LQ/NOPB	WQFN	NJB	28	1000	210.0	185.0	35.0
LM2647LQX/NOPB	WQFN	NJB	28	4500	367.0	367.0	35.0
LM2647MTCX/NOPB	TSSOP	PW	28	2500	367.0	367.0	38.0

MECHANICAL DATA

PW (R-PDSO-G28)

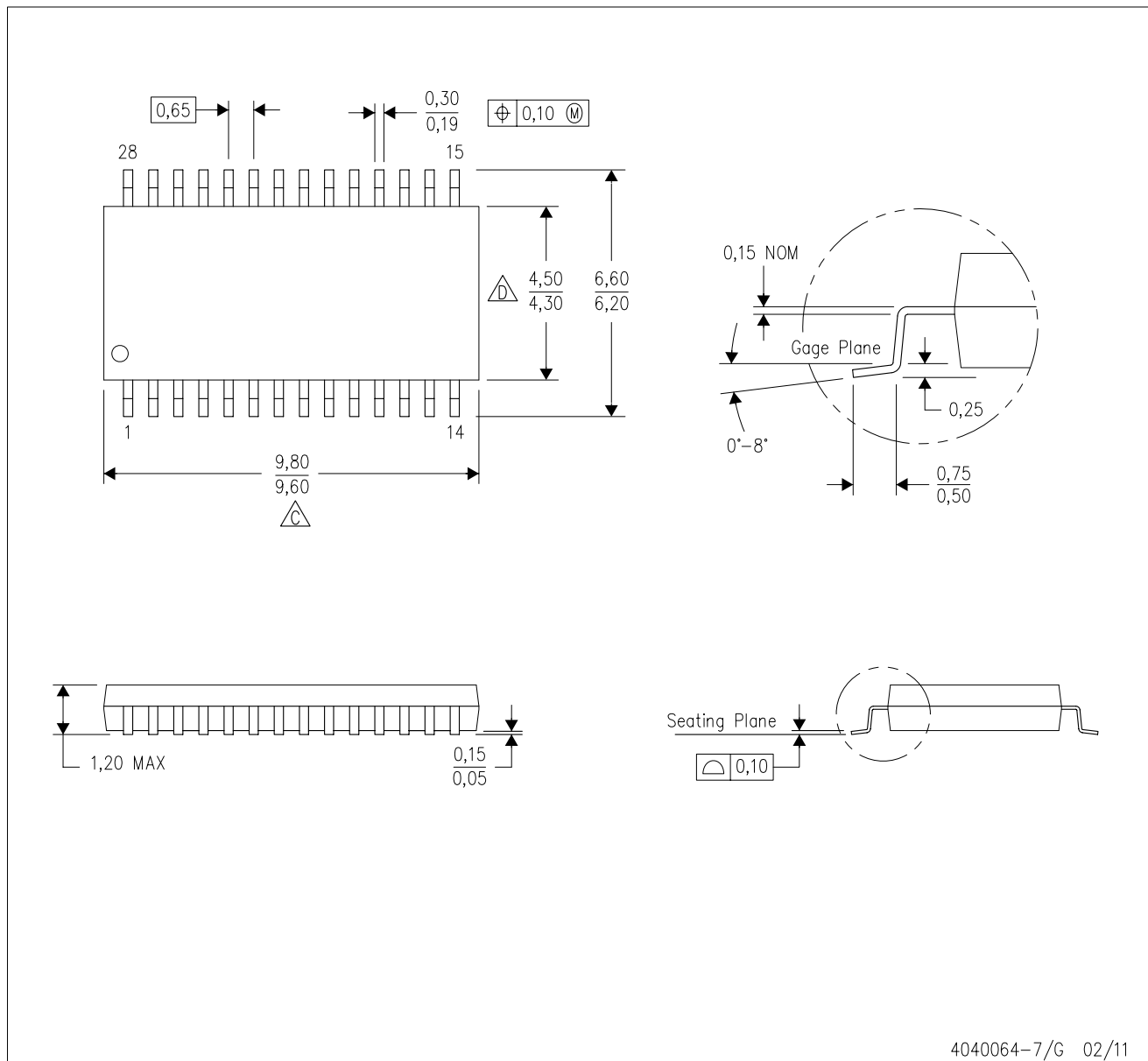
PLASTIC SMALL OUTLINE



4040064-7/G 02/11

- NOTES:
- A. All linear dimensions are in millimeters. Dimensioning and tolerancing per ASME Y14.5M-1994.
 - B. This drawing is subject to change without notice.
 - C. Body length does not include mold flash, protrusions, or gate burrs. Mold flash, protrusions, or gate burrs shall not exceed 0,15 each side.
 - D. Body width does not include interlead flash. Interlead flash shall not exceed 0,25 each side.
 - E. Falls within JEDEC MO-153

NJB0028A

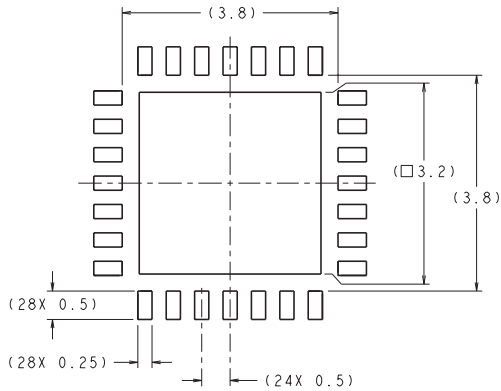

RECOMMENDED LAND PATTERN
1:1 RATION WITH PKG SOLDER PADS

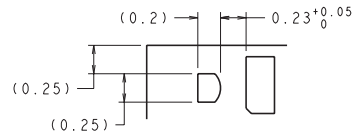

DETAIL A
SCALE: 40X

DIMENSIONS ARE IN MILLIMETERS

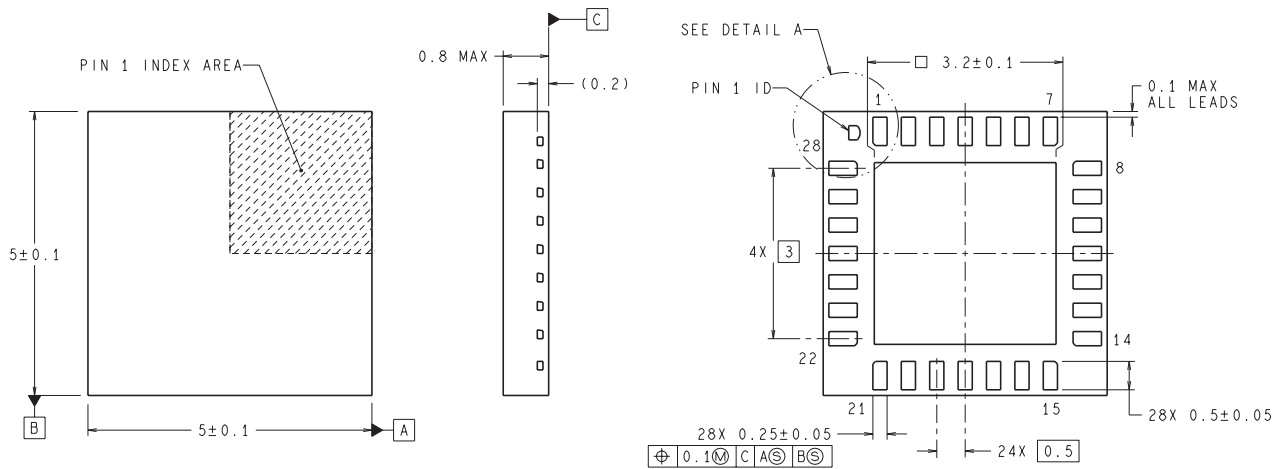

LQA28A (REV B)

IMPORTANT NOTICE

Texas Instruments Incorporated and its subsidiaries (TI) reserve the right to make corrections, enhancements, improvements and other changes to its semiconductor products and services per JESD46, latest issue, and to discontinue any product or service per JESD48, latest issue. Buyers should obtain the latest relevant information before placing orders and should verify that such information is current and complete. All semiconductor products (also referred to herein as "components") are sold subject to TI's terms and conditions of sale supplied at the time of order acknowledgment.

TI warrants performance of its components to the specifications applicable at the time of sale, in accordance with the warranty in TI's terms and conditions of sale of semiconductor products. Testing and other quality control techniques are used to the extent TI deems necessary to support this warranty. Except where mandated by applicable law, testing of all parameters of each component is not necessarily performed.

TI assumes no liability for applications assistance or the design of Buyers' products. Buyers are responsible for their products and applications using TI components. To minimize the risks associated with Buyers' products and applications, Buyers should provide adequate design and operating safeguards.

TI does not warrant or represent that any license, either express or implied, is granted under any patent right, copyright, mask work right, or other intellectual property right relating to any combination, machine, or process in which TI components or services are used. Information published by TI regarding third-party products or services does not constitute a license to use such products or services or a warranty or endorsement thereof. Use of such information may require a license from a third party under the patents or other intellectual property of the third party, or a license from TI under the patents or other intellectual property of TI.

Reproduction of significant portions of TI information in TI data books or data sheets is permissible only if reproduction is without alteration and is accompanied by all associated warranties, conditions, limitations, and notices. TI is not responsible or liable for such altered documentation. Information of third parties may be subject to additional restrictions.

Resale of TI components or services with statements different from or beyond the parameters stated by TI for that component or service voids all express and any implied warranties for the associated TI component or service and is an unfair and deceptive business practice. TI is not responsible or liable for any such statements.

Buyer acknowledges and agrees that it is solely responsible for compliance with all legal, regulatory and safety-related requirements concerning its products, and any use of TI components in its applications, notwithstanding any applications-related information or support that may be provided by TI. Buyer represents and agrees that it has all the necessary expertise to create and implement safeguards which anticipate dangerous consequences of failures, monitor failures and their consequences, lessen the likelihood of failures that might cause harm and take appropriate remedial actions. Buyer will fully indemnify TI and its representatives against any damages arising out of the use of any TI components in safety-critical applications.

In some cases, TI components may be promoted specifically to facilitate safety-related applications. With such components, TI's goal is to help enable customers to design and create their own end-product solutions that meet applicable functional safety standards and requirements. Nonetheless, such components are subject to these terms.

No TI components are authorized for use in FDA Class III (or similar life-critical medical equipment) unless authorized officers of the parties have executed a special agreement specifically governing such use.

Only those TI components which TI has specifically designated as military grade or "enhanced plastic" are designed and intended for use in military/aerospace applications or environments. Buyer acknowledges and agrees that any military or aerospace use of TI components which have **not** been so designated is solely at the Buyer's risk, and that Buyer is solely responsible for compliance with all legal and regulatory requirements in connection with such use.

TI has specifically designated certain components as meeting ISO/TS16949 requirements, mainly for automotive use. In any case of use of non-designated products, TI will not be responsible for any failure to meet ISO/TS16949.

Products

Audio	www.ti.com/audio
Amplifiers	amplifier.ti.com
Data Converters	dataconverter.ti.com
DLP® Products	www.dlp.com
DSP	dsp.ti.com
Clocks and Timers	www.ti.com/clocks
Interface	interface.ti.com
Logic	logic.ti.com
Power Mgmt	power.ti.com
Microcontrollers	microcontroller.ti.com
RFID	www.ti-rfid.com
OMAP Applications Processors	www.ti.com/omap
Wireless Connectivity	www.ti.com/wirelessconnectivity

Applications

Automotive and Transportation	www.ti.com/automotive
Communications and Telecom	www.ti.com/communications
Computers and Peripherals	www.ti.com/computers
Consumer Electronics	www.ti.com/consumer-apps
Energy and Lighting	www.ti.com/energy
Industrial	www.ti.com/industrial
Medical	www.ti.com/medical
Security	www.ti.com/security
Space, Avionics and Defense	www.ti.com/space-avionics-defense
Video and Imaging	www.ti.com/video

TI E2E Community

e2e.ti.com