

**FEATURES**

- Output Voltage Range Adjustable From 1.25 V to 37 V
- Output Current Greater Than 500 mA
- Internal Short-Circuit Current Limiting
- Thermal-Overload Protection
- Output Safe-Area Compensation
- Q Devices Meet Automotive Performance Requirements
- Customer-Specific Configuration Control Can Be Supported for Q Devices Along With Major-Change Approval

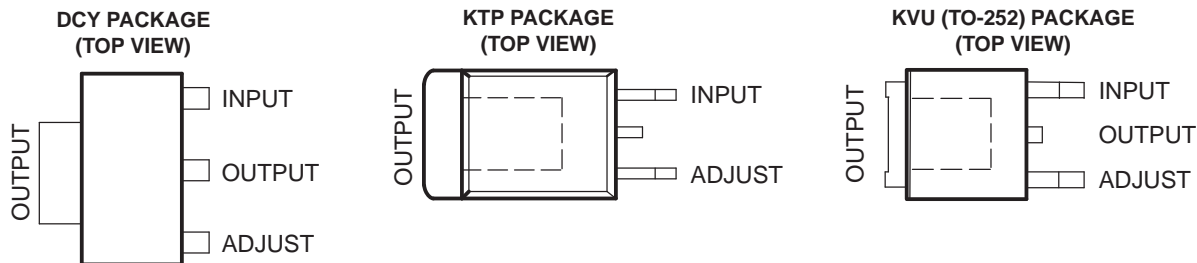

**DESCRIPTION/ORDERING INFORMATION**

The LM317M is an adjustable 3-terminal positive-voltage regulator capable of supplying more than 500 mA over an output-voltage range of 1.25 V to 37 V. The LM317M is exceptionally easy to use and requires only two external resistors to set the output voltage. Furthermore, both line and load regulation are better than standard fixed regulators.

In addition to having higher performance than fixed regulators, the device includes on-chip current limiting, thermal-overload protection, and safe-operating-area protection. All overload protection remains fully functional if the ADJUST terminal is disconnected.

Normally, no capacitors are needed unless the device is more than six inches from the input filter capacitors, in which case an input bypass capacitor is needed. An optional output capacitor can be added to improve transient response. The ADJUST terminal can be bypassed to achieve high ripple-rejection ratios, which are difficult to achieve with standard three-terminal regulators.

**ORDERING INFORMATION**

T <sub>J</sub>	PACKAGE (1)		ORDERABLE PART NUMBER	TOP-SIDE MARKING
0°C to 125°C	PowerFLEX™ – KTP	Reel of 2000	LM317MKTPR	LM317M
	SOT – DCY	Tube of 80	LM317MDCY	L4
		Reel of 2500	LM317MDCYR	
	TO-252 – KVU	Reel of 2500	LM317MKVURG3	LM317M
–40°C to 125°C	PowerFLEX – KTP	Reel of 2000	LM317MQKTPR	317MQ
	SOT – DCY	Reel of 2500	LM317MQDCYR	L5
			LM317MQDCYRG3	L8

(1) Package drawings, standard packing quantities, thermal data, symbolization, and PCB design guidelines are available at [www.ti.com/sc/package](http://www.ti.com/sc/package).



Please be aware that an important notice concerning availability, standard warranty, and use in critical applications of Texas Instruments semiconductor products and disclaimers thereto appears at the end of this data sheet.

PowerFLEX is a trademark of Texas Instruments.

# LM317M

## 3-TERMINAL ADJUSTABLE REGULATOR

SLVS2970–APRIL 2000–REVISED JULY 2006

### Absolute Maximum Ratings<sup>(1)</sup>

over operating temperature range (unless otherwise noted)

		MIN	MAX	UNIT
$V_I - V_O$	Input-to-output differential voltage		40	V
$T_J$	Operating virtual junction temperature		150	°C
	Lead temperature (within 5 mils of the plastic body for 10 s)		260	°C
		KTP, DCY packages		
$T_{stg}$	Storage temperature range	-65	150	°C

(1) Stresses beyond those listed under "absolute maximum ratings" may cause permanent damage to the device. These are stress ratings only, and functional operation of the device at these or any other conditions beyond those indicated under "recommended operating conditions" is not implied. Exposure to absolute-maximum-rated conditions for extended periods may affect device reliability.

### Package Thermal Data<sup>(1)</sup>

PACKAGE	BOARD	$\theta_{JC}$	$\theta_{JCB}$	$\theta_{JA}$
PowerFLEX (KTP)	High K, JESD 51-5		3°C/W	28°C/W
SOT-223 (DCY)	High K, JESD 51-7	30.6°C/W		53°C/W
TO-252 (KVU)	High K, JESD 51-5			30.3°C/W

(1) Maximum power dissipation is a function of  $T_J(\max)$ ,  $\theta_{JA}$ , and  $T_A$ . The maximum allowable power dissipation at any allowable ambient temperature is  $P_D = (T_J(\max) - T_A)/\theta_{JA}$ . Operating at the absolute maximum  $T_J$  of 150°C can affect reliability.

### Recommended Operating Conditions

		MIN	MAX	UNIT
$V_I - V_O$	Input-to-output voltage differential		37	V
$I_O$	Output current		0.5	A
$T_J$	Operating virtual junction temperature	No suffix	0	125
		Q suffix	-40	125

### Electrical Characteristics

over recommended operating virtual-junction temperature range,  $V_I - V_O = 5$  V,  $I_O = 0.1$  A (unless otherwise noted)

PARAMETER	TEST CONDITIONS <sup>(1)</sup>		MIN	TYP	MAX	UNIT
Line regulation <sup>(2)</sup>	$V_I - V_O = 3$ V to 40 V	$T_J = 25^\circ\text{C}$		0.01	0.04	%V
		Full temperature range		0.02	0.07	
Load regulation	$I_O = 10$ mA to 500 mA	$T_J = 25^\circ\text{C}$		0.1	0.5	%V <sub>O</sub>
		Full temperature range		0.3	1.5	
ADJUST terminal current				50	100	μA
Change in ADJUST terminal current	$V_I - V_O = 3$ V to 40 V,	$I_O = 10$ mA to 500 mA		0.2	5	μA
Reference voltage	$V_I - V_O = 3$ V to 40 V,	$I_O = 10$ mA to 500 mA	1.2	1.25	1.3	V
Output-voltage temperature stability				0.7		%
Minimum load current to maintain regulation				3.5	10	mA
Maximum output current	$V_I - V_O \leq 15$ V		500	900		mA
	$V_I - V_O = 40$ V, $P_D \leq P_{D(\max)}$ ,	$T_J = 25^\circ\text{C}$	150	250		
RMS output noise voltage (% of V <sub>O</sub> )	$f = 10$ Hz to 10 kHz,	$T_J = 25^\circ\text{C}$		0.003		%V <sub>O</sub>
Ripple rejection	$V_O = 10$ V, $f = 120$ Hz, $T_J = 25^\circ\text{C}$	$C_{ADJ} = 0^{(3)}$		65		dB
		$C_{ADJ} = 10$ μF <sup>(3)</sup>	66	80		
Long-term stability	$T_J = 25^\circ\text{C}$			0.3	1	%/1k hrs

- (1) Pulse-testing techniques are used to maintain the junction temperature as close to the ambient temperature as possible.  
 (2) Line voltage regulation is expressed here as the percentage change in output voltage per 1-V change at the input.  
 (3) CADJ is connected between the ADJUST terminal and ground.

**TYPICAL CHARACTERISTICS**

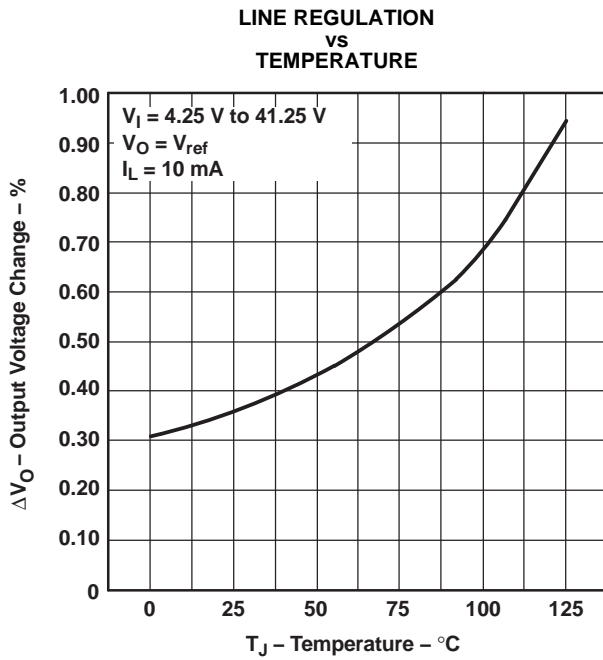

Figure 1.

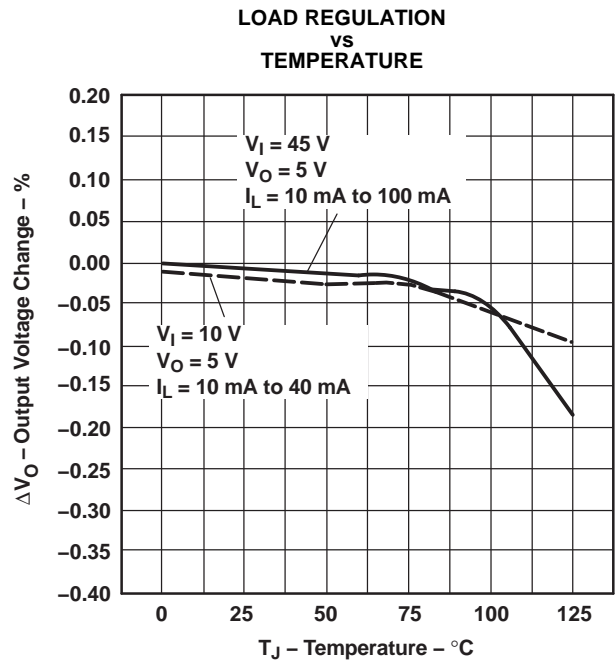

Figure 2.

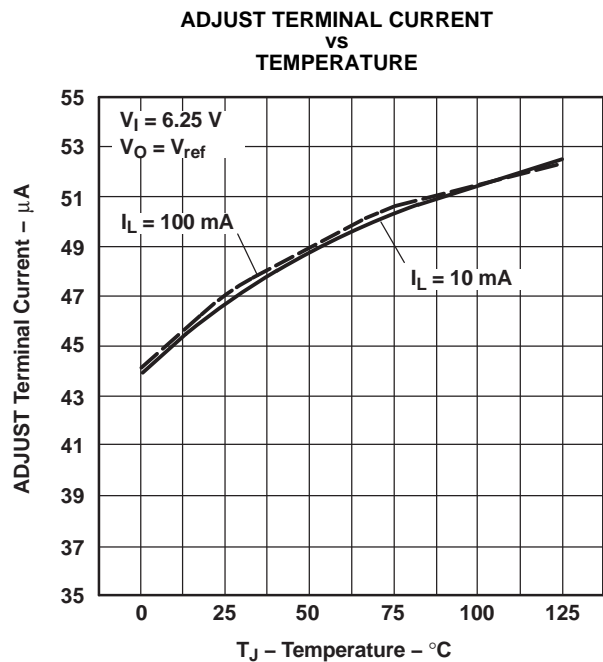

Figure 3.

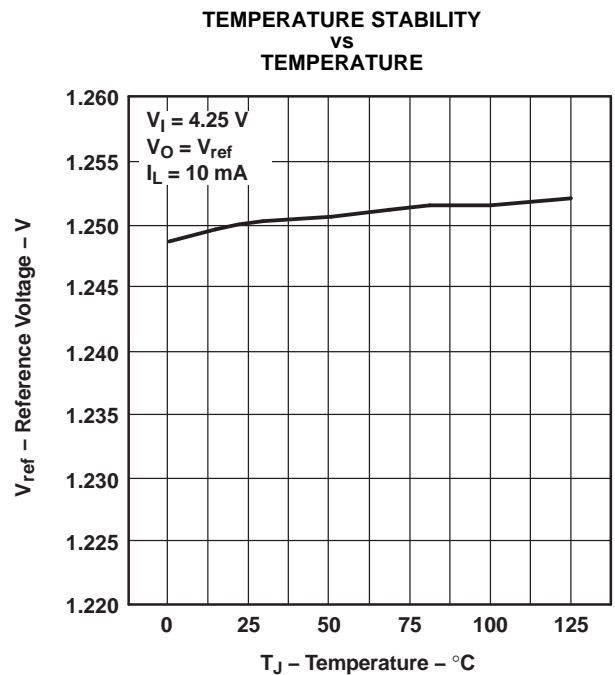

Figure 4.

TYPICAL CHARACTERISTICS (continued)

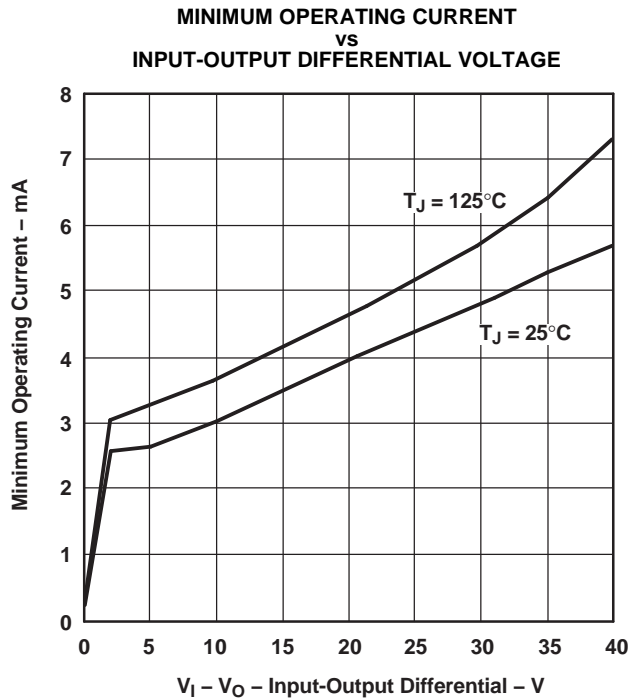

Figure 5.

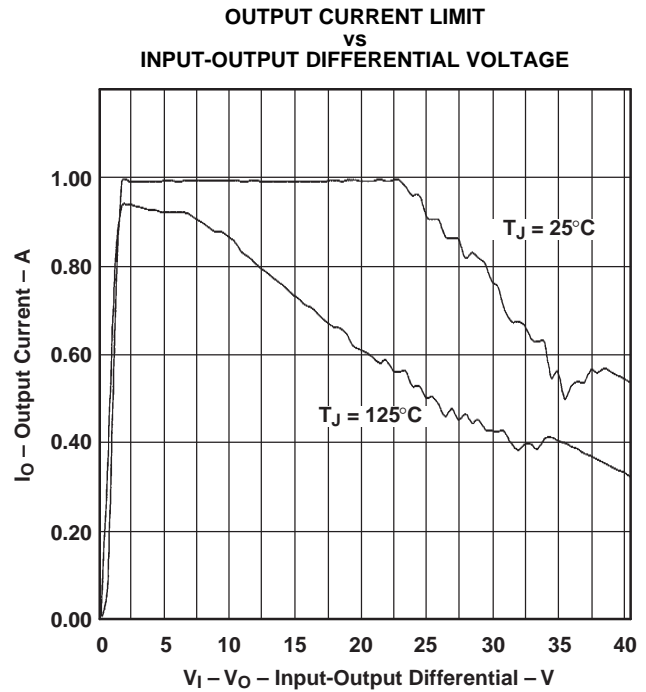

Figure 6.

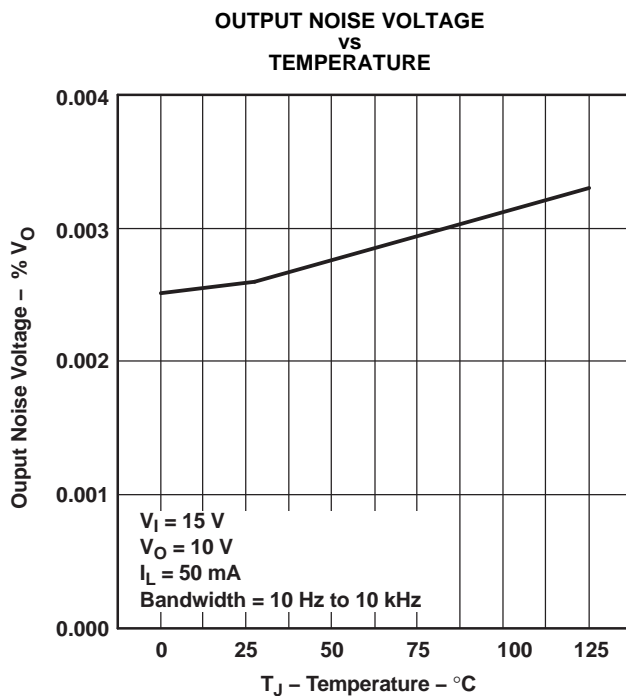

Figure 7.

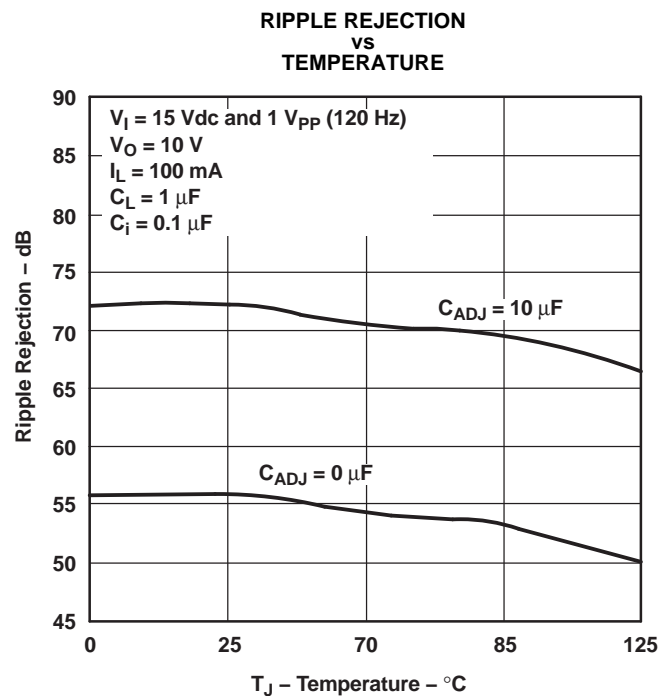

Figure 8.

**TYPICAL CHARACTERISTICS (continued)**

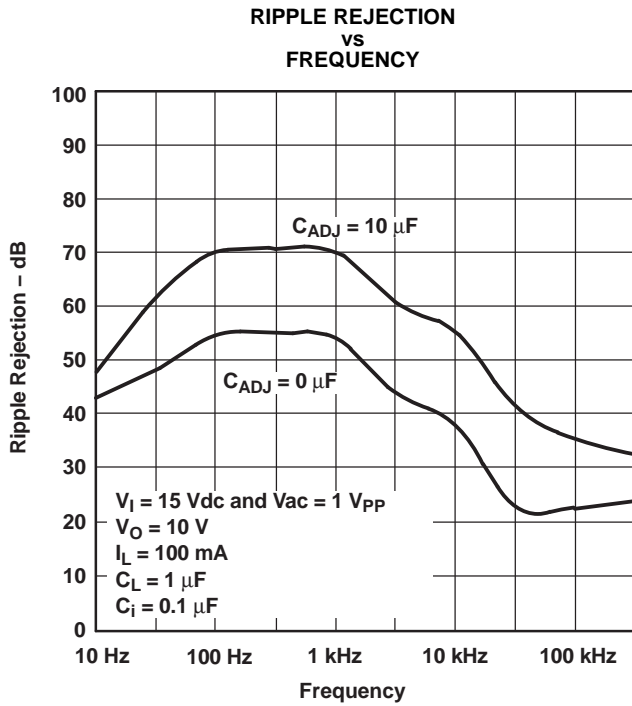

Figure 9.

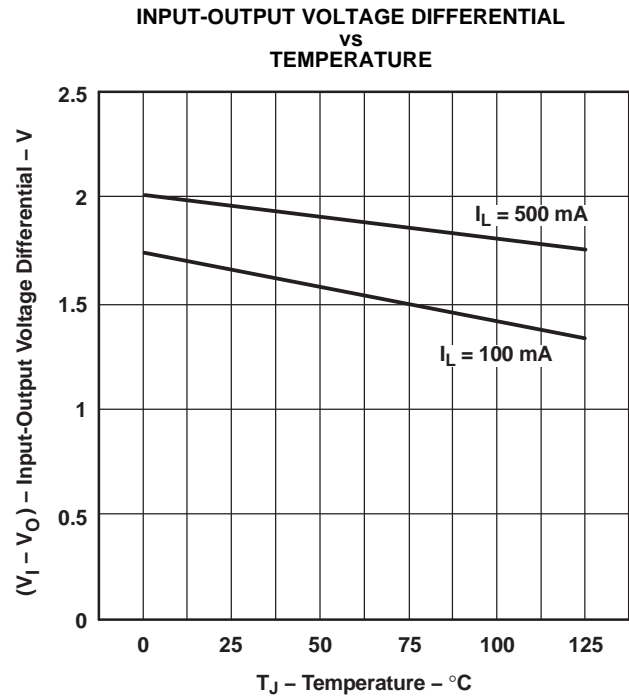

Figure 10.

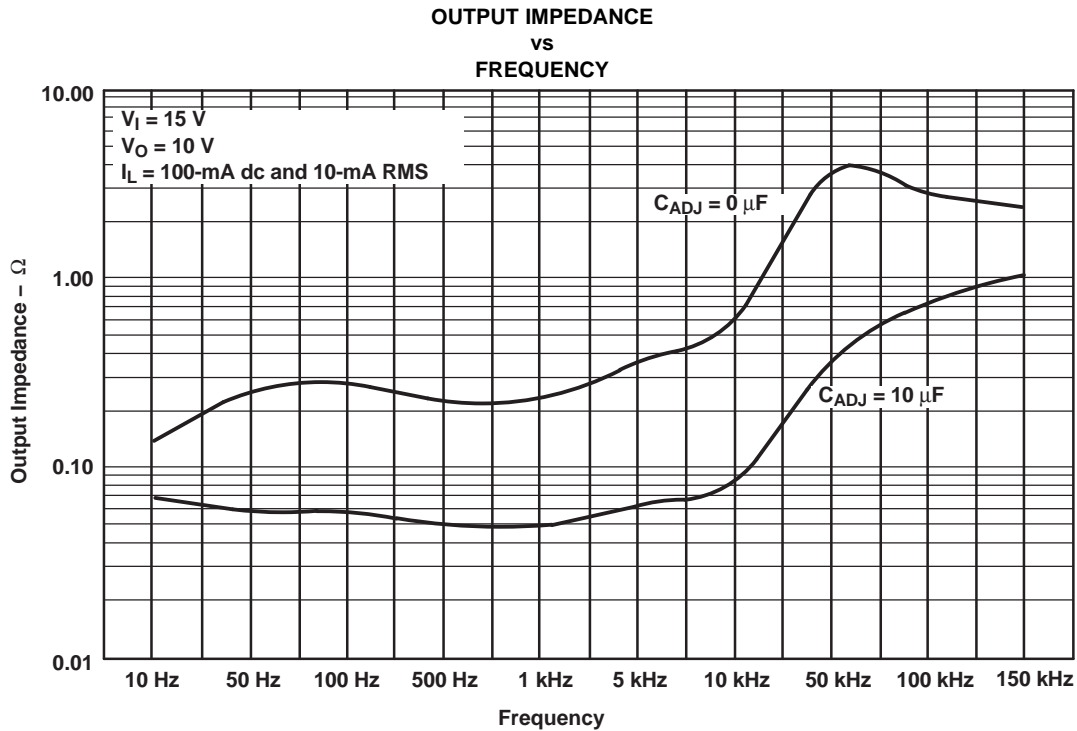

Figure 11.

TYPICAL CHARACTERISTICS (continued)

LINE TRANSIENT RESPONSE  
vs  
TIME

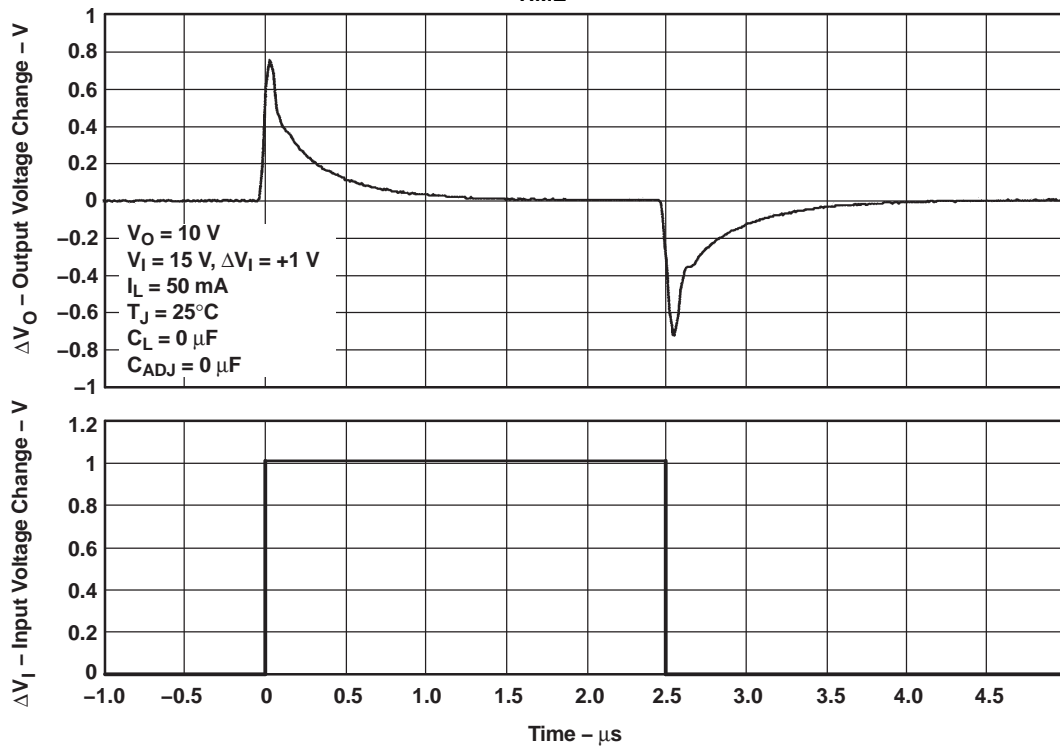

Figure 12.

LOAD TRANSIENT RESPONSE  
vs  
TIME

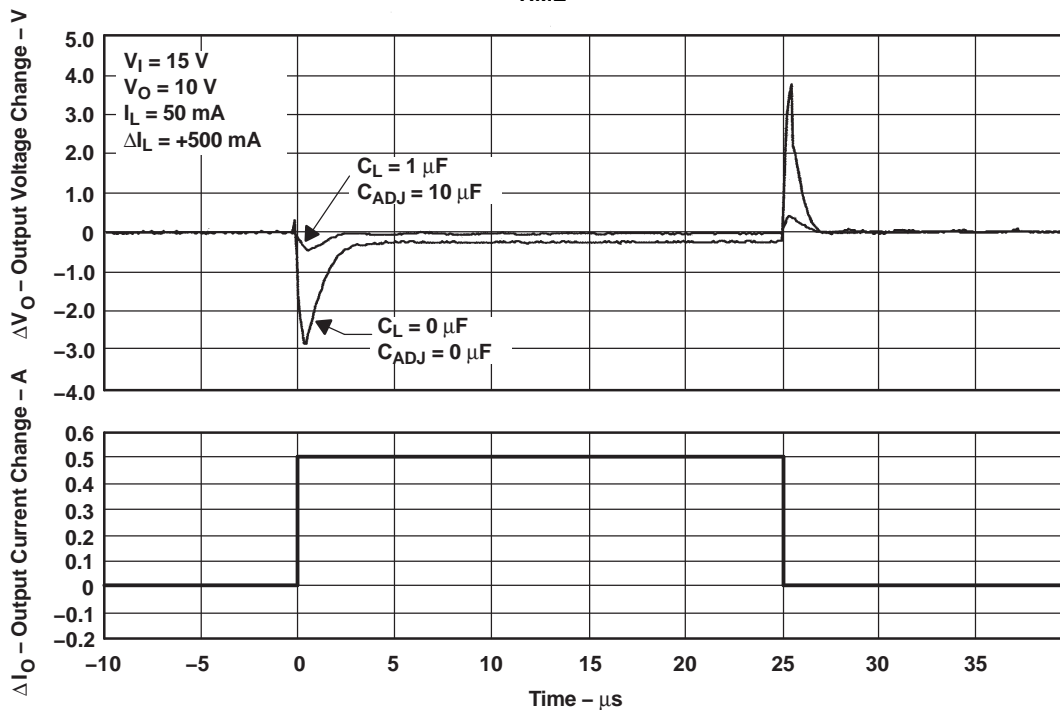
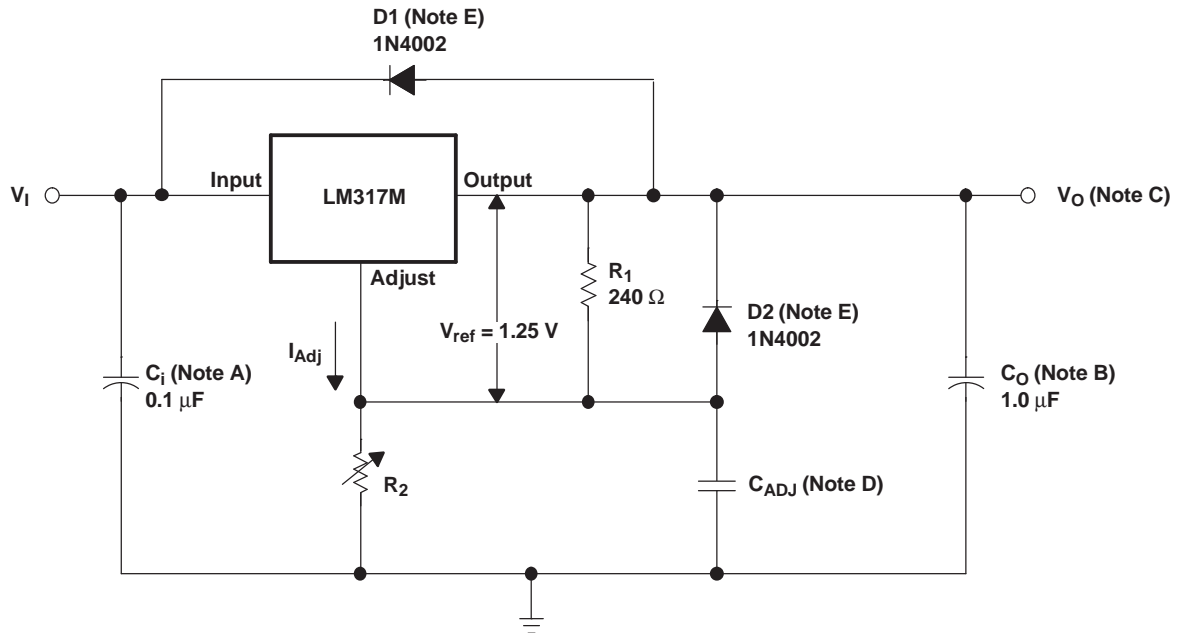

Figure 13.

APPLICATION INFORMATION



- NOTES: A.  $C_i$  is not required, but is recommended, particularly if the regulator is not in close proximity to the power-supply filter capacitors. A 0.1- $\mu$ F disc or 1- $\mu$ F tantalum provides sufficient bypassing for most applications, especially when adjustment and output capacitors are used.
- B.  $C_o$  improves transient response, but is not needed for stability.
- C.  $V_o$  is calculated as shown:

$$V_o = V_{ref} \left( 1 + \frac{R_2}{R_1} \right) + (I_{Adj} \times R_2)$$

Because  $I_{Adj}$  typically is 50  $\mu$ A, it is negligible in most applications.

- D.  $C_{ADJ}$  is used to improve ripple rejection; it prevents amplification of the ripple as the output voltage is adjusted higher. If  $C_{ADJ}$  is used, it is best to include protection diodes.
- E. If the input is shorted to ground during a fault condition, protection diodes provide measures to prevent the possibility of external capacitors discharging through low-impedance paths in the IC. By providing low-impedance discharge paths for  $C_o$  and  $C_{ADJ}$ , respectively, D1 and D2 prevent the capacitors from discharging into the output of the regulator.

Figure 14. Adjustable Voltage Regulator

**PACKAGING INFORMATION**

Orderable Device	Status (1)	Package Type	Package Drawing	Pins	Package Qty	Eco Plan (2)	Lead/Ball Finish	MSL Peak Temp (3)	Op Temp (°C)	Device Marking (4/5)	Samples
LM317MDCY	ACTIVE	SOT-223	DCY	4	80	Green (RoHS & no Sb/Br)	CU SN	Level-2-260C-1 YEAR	0 to 125	L4	<a href="#">Samples</a>
LM317MDCYG3	ACTIVE	SOT-223	DCY	4	80	Green (RoHS & no Sb/Br)	CU SN	Level-2-260C-1 YEAR	0 to 125	L4	<a href="#">Samples</a>
LM317MDCYR	ACTIVE	SOT-223	DCY	4	2500	Green (RoHS & no Sb/Br)	CU SN	Level-2-260C-1 YEAR	0 to 125	L4	<a href="#">Samples</a>
LM317MDCYRG3	ACTIVE	SOT-223	DCY	4	2500	Green (RoHS & no Sb/Br)	CU SN	Level-2-260C-1 YEAR	0 to 125	L4	<a href="#">Samples</a>
LM317MKTPR	OBSOLETE	PFM	KTP	2		TBD	Call TI	Call TI	0 to 125	LM317M	
LM317MKTPRG3	OBSOLETE	PFM	KTP	2		TBD	Call TI	Call TI	0 to 125	LM317M	
LM317MKVURG3	ACTIVE	TO-252	KVU	3	2500	Green (RoHS & no Sb/Br)	CU SN	Level-3-260C-168 HR	0 to 125	LM317M	<a href="#">Samples</a>
LM317MQDCYR	ACTIVE	SOT-223	DCY	4	2500	Green (RoHS & no Sb/Br)	CU NIPDAU	Level-2-260C-1 YEAR	-40 to 125	L5	<a href="#">Samples</a>
LM317MQDCYRG4	ACTIVE	SOT-223	DCY	4	2500	Green (RoHS & no Sb/Br)	CU NIPDAU	Level-2-260C-1 YEAR	-40 to 125	L5	<a href="#">Samples</a>
LM317MQKTPR	OBSOLETE	PFM	KTP	2		TBD	Call TI	Call TI	-40 to 125		

(1) The marketing status values are defined as follows:

**ACTIVE:** Product device recommended for new designs.

**LIFEBUY:** TI has announced that the device will be discontinued, and a lifetime-buy period is in effect.

**NRND:** Not recommended for new designs. Device is in production to support existing customers, but TI does not recommend using this part in a new design.

**PREVIEW:** Device has been announced but is not in production. Samples may or may not be available.

**OBSOLETE:** TI has discontinued the production of the device.

(2) Eco Plan - The planned eco-friendly classification: Pb-Free (RoHS), Pb-Free (RoHS Exempt), or Green (RoHS & no Sb/Br) - please check <http://www.ti.com/productcontent> for the latest availability information and additional product content details.

**TBD:** The Pb-Free/Green conversion plan has not been defined.

**Pb-Free (RoHS):** TI's terms "Lead-Free" or "Pb-Free" mean semiconductor products that are compatible with the current RoHS requirements for all 6 substances, including the requirement that lead not exceed 0.1% by weight in homogeneous materials. Where designed to be soldered at high temperatures, TI Pb-Free products are suitable for use in specified lead-free processes.

**Pb-Free (RoHS Exempt):** This component has a RoHS exemption for either 1) lead-based flip-chip solder bumps used between the die and package, or 2) lead-based die adhesive used between the die and leadframe. The component is otherwise considered Pb-Free (RoHS compatible) as defined above.

**Green (RoHS & no Sb/Br):** TI defines "Green" to mean Pb-Free (RoHS compatible), and free of Bromine (Br) and Antimony (Sb) based flame retardants (Br or Sb do not exceed 0.1% by weight in homogeneous material)

(3) MSL, Peak Temp. -- The Moisture Sensitivity Level rating according to the JEDEC industry standard classifications, and peak solder temperature.



(4) There may be additional marking, which relates to the logo, the lot trace code information, or the environmental category on the device.

(5) Multiple Device Markings will be inside parentheses. Only one Device Marking contained in parentheses and separated by a "~" will appear on a device. If a line is indented then it is a continuation of the previous line and the two combined represent the entire Device Marking for that device.

**Important Information and Disclaimer:**The information provided on this page represents TI's knowledge and belief as of the date that it is provided. TI bases its knowledge and belief on information provided by third parties, and makes no representation or warranty as to the accuracy of such information. Efforts are underway to better integrate information from third parties. TI has taken and continues to take reasonable steps to provide representative and accurate information but may not have conducted destructive testing or chemical analysis on incoming materials and chemicals. TI and TI suppliers consider certain information to be proprietary, and thus CAS numbers and other limited information may not be available for release.

In no event shall TI's liability arising out of such information exceed the total purchase price of the TI part(s) at issue in this document sold by TI to Customer on an annual basis.

**TAPE AND REEL INFORMATION**

**QUADRANT ASSIGNMENTS FOR PIN 1 ORIENTATION IN TAPE**

\*All dimensions are nominal

Device	Package Type	Package Drawing	Pins	SPQ	Reel Diameter (mm)	Reel Width W1 (mm)	A0 (mm)	B0 (mm)	K0 (mm)	P1 (mm)	W (mm)	Pin1 Quadrant
LM317MDCYR	SOT-223	DCY	4	2500	330.0	12.4	7.05	7.4	1.9	8.0	12.0	Q3
LM317MKVURG3	TO-252	KVU	3	2500	330.0	16.4	6.9	10.5	2.7	8.0	16.0	Q2
LM317MQDCYR	SOT-223	DCY	4	2500	330.0	12.4	6.83	7.42	1.88	8.0	12.0	Q3
LM317MQDCYRG4	SOT-223	DCY	4	2500	330.0	12.4	6.83	7.42	1.88	8.0	12.0	Q3

**TAPE AND REEL BOX DIMENSIONS**

\*All dimensions are nominal

Device	Package Type	Package Drawing	Pins	SPQ	Length (mm)	Width (mm)	Height (mm)
LM317MDCYR	SOT-223	DCY	4	2500	340.0	340.0	38.0
LM317MKVURG3	TO-252	KVU	3	2500	340.0	340.0	38.0
LM317MQDCYR	SOT-223	DCY	4	2500	358.0	335.0	35.0
LM317MQDCYRG4	SOT-223	DCY	4	2500	358.0	335.0	35.0

DCY (R-PDSO-G4)

PLASTIC SMALL-OUTLINE



- NOTES: A. All linear dimensions are in millimeters (inches).  
 B. This drawing is subject to change without notice.  
 C. Body dimensions do not include mold flash or protrusion.  
 D. Falls within JEDEC TO-261 Variation AA.

DCY (R-PDSO-G4)

PLASTIC SMALL OUTLINE

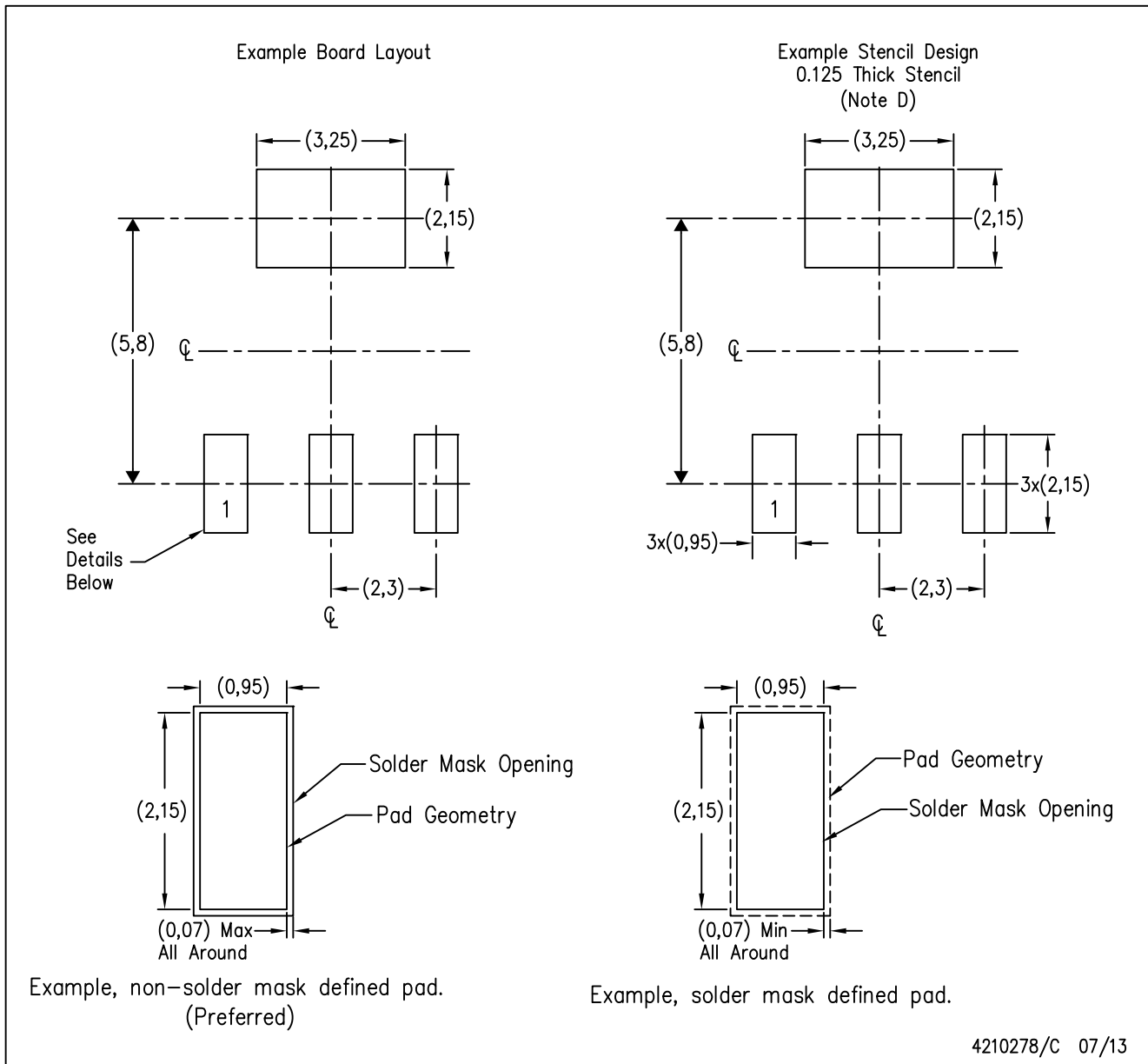

- NOTES:
- A. All linear dimensions are in millimeters.
  - B. This drawing is subject to change without notice.
  - C. Publication IPC-7351 is recommended for alternate designs.
  - D. Laser cutting apertures with trapezoidal walls and also rounding corners will offer better paste release. Customers should contact their board assembly site for stencil recommendations. Refer to IPC 7525 for stencil design considerations.

KTP (R-PSFM-G2)

PowerFLEX™ PLASTIC FLANGE-MOUNT PACKAGE

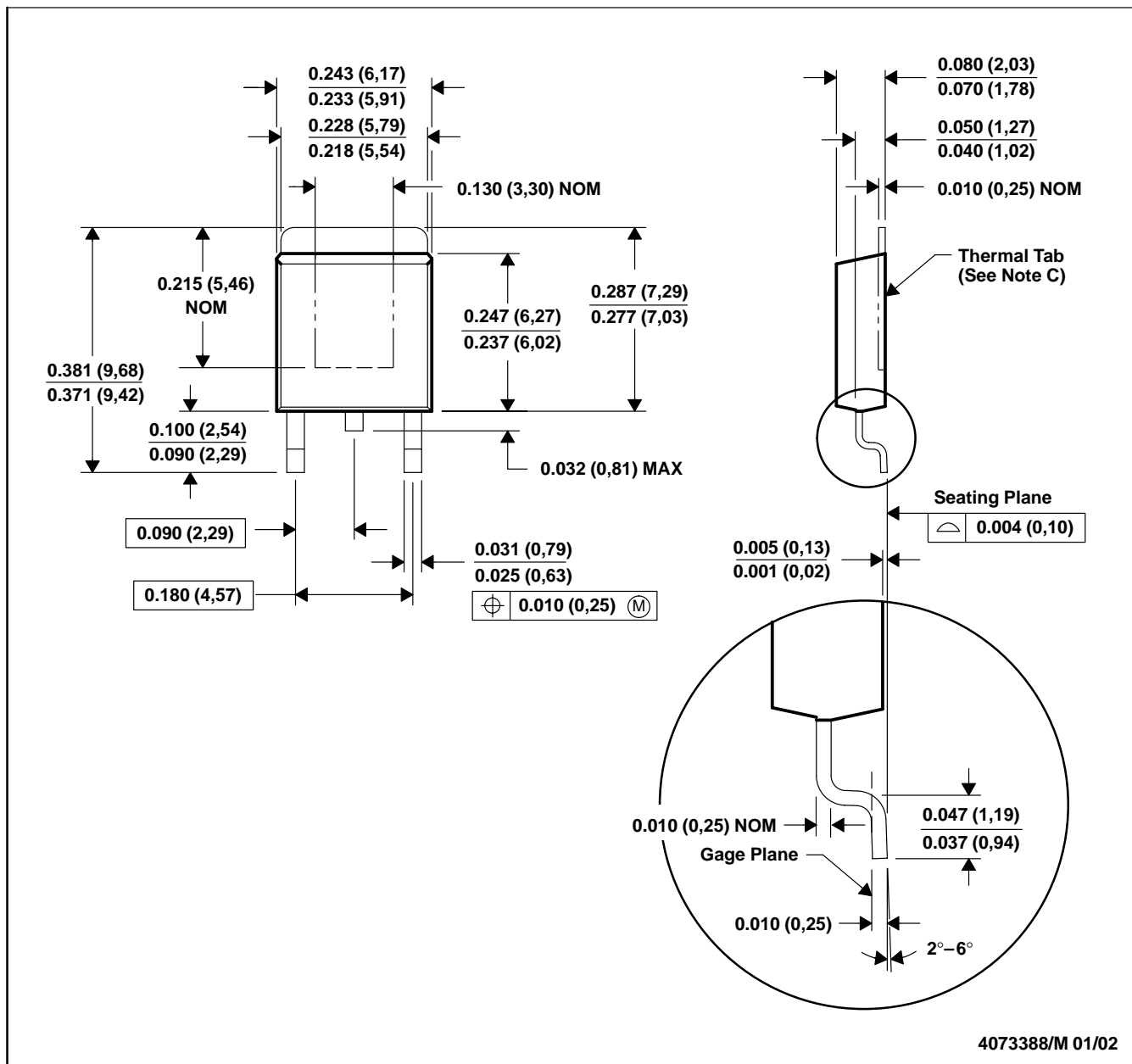

- NOTES: A. All linear dimensions are in inches (millimeters).  
 B. This drawing is subject to change without notice.  
 C. The center lead is in electrical contact with the thermal tab.  
 D. Dimensions do not include mold protrusions, not to exceed 0.006 (0,15).  
 E. Falls within JEDEC TO-252 variation AC.

PowerFLEX is a trademark of Texas Instruments.



# MECHANICAL DATA

KVU (R-PSFM-G3)

PLASTIC FLANGE-MOUNT PACKAGE

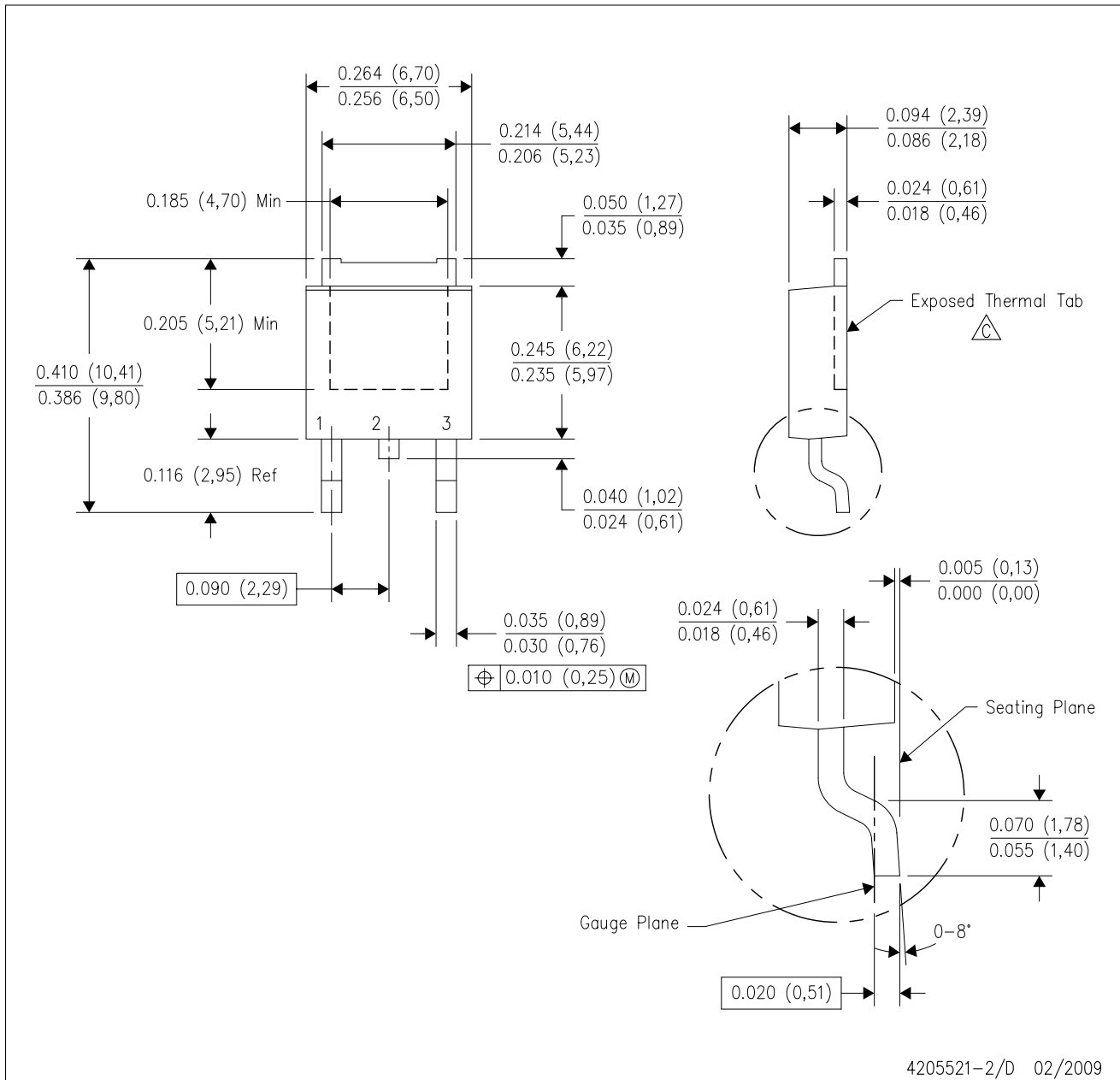

KVU (R-PSFM-G3)

PLASTIC FLANGE MOUNT PACKAGE

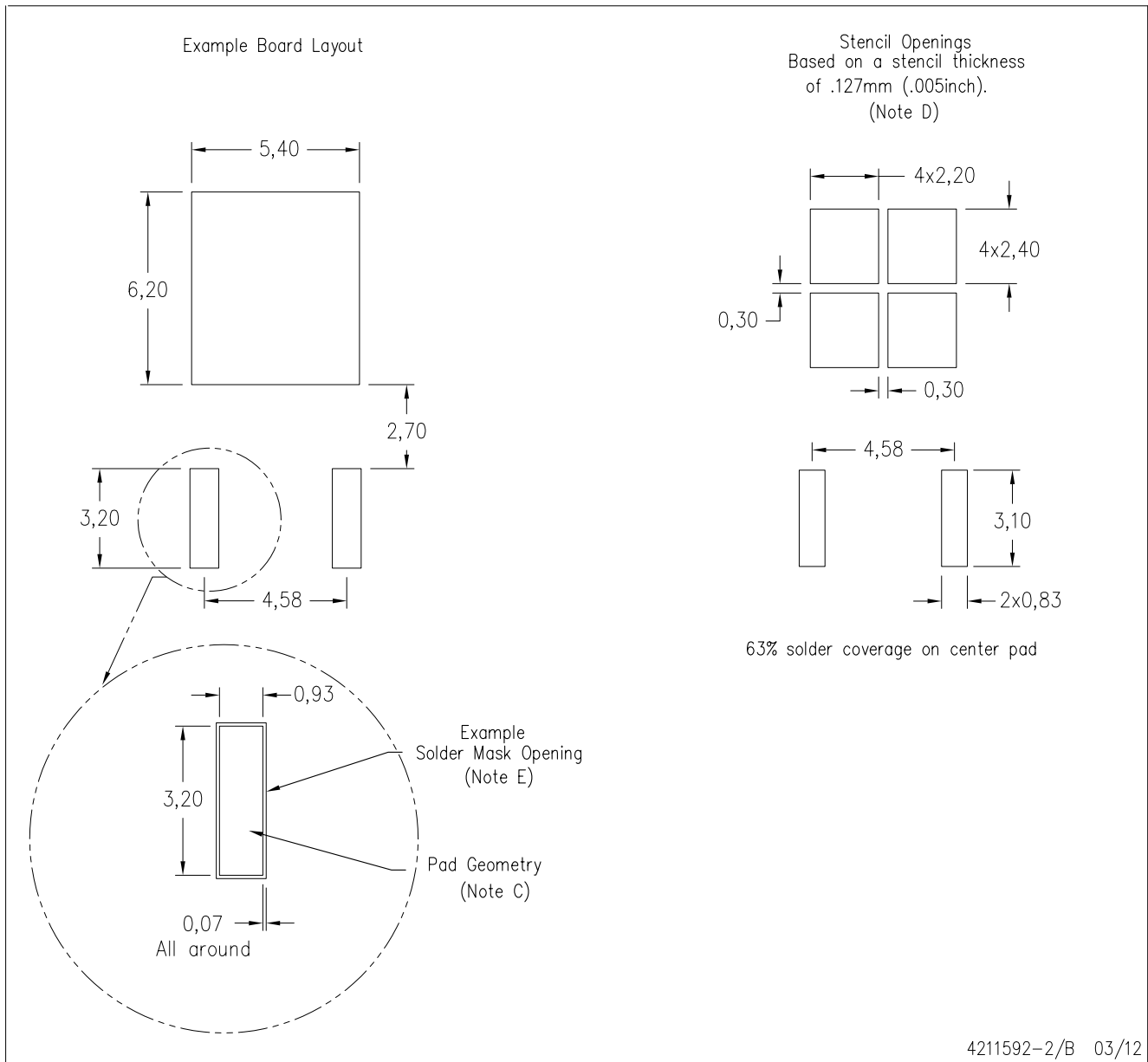

- NOTES:
- A. All linear dimensions are in millimeters.
  - B. This drawing is subject to change without notice.
  - C. Publication IPC-SM-782 is an alternate information source for PCB land pattern designs.
  - D. Laser cutting apertures with trapezoidal walls and also rounding corners will offer better paste release. Customers should contact their board assembly site for stencil design recommendations. Refer to IPC-7525 for other stencil recommendations.
  - E. Customers should contact their board fabrication site for recommended solder mask tolerances and via tenting recommendations for vias placed in thermal pad.



## IMPORTANT NOTICE

Texas Instruments Incorporated and its subsidiaries (TI) reserve the right to make corrections, enhancements, improvements and other changes to its semiconductor products and services per JESD46, latest issue, and to discontinue any product or service per JESD48, latest issue. Buyers should obtain the latest relevant information before placing orders and should verify that such information is current and complete. All semiconductor products (also referred to herein as "components") are sold subject to TI's terms and conditions of sale supplied at the time of order acknowledgment.

TI warrants performance of its components to the specifications applicable at the time of sale, in accordance with the warranty in TI's terms and conditions of sale of semiconductor products. Testing and other quality control techniques are used to the extent TI deems necessary to support this warranty. Except where mandated by applicable law, testing of all parameters of each component is not necessarily performed.

TI assumes no liability for applications assistance or the design of Buyers' products. Buyers are responsible for their products and applications using TI components. To minimize the risks associated with Buyers' products and applications, Buyers should provide adequate design and operating safeguards.

TI does not warrant or represent that any license, either express or implied, is granted under any patent right, copyright, mask work right, or other intellectual property right relating to any combination, machine, or process in which TI components or services are used. Information published by TI regarding third-party products or services does not constitute a license to use such products or services or a warranty or endorsement thereof. Use of such information may require a license from a third party under the patents or other intellectual property of the third party, or a license from TI under the patents or other intellectual property of TI.

Reproduction of significant portions of TI information in TI data books or data sheets is permissible only if reproduction is without alteration and is accompanied by all associated warranties, conditions, limitations, and notices. TI is not responsible or liable for such altered documentation. Information of third parties may be subject to additional restrictions.

Resale of TI components or services with statements different from or beyond the parameters stated by TI for that component or service voids all express and any implied warranties for the associated TI component or service and is an unfair and deceptive business practice. TI is not responsible or liable for any such statements.

Buyer acknowledges and agrees that it is solely responsible for compliance with all legal, regulatory and safety-related requirements concerning its products, and any use of TI components in its applications, notwithstanding any applications-related information or support that may be provided by TI. Buyer represents and agrees that it has all the necessary expertise to create and implement safeguards which anticipate dangerous consequences of failures, monitor failures and their consequences, lessen the likelihood of failures that might cause harm and take appropriate remedial actions. Buyer will fully indemnify TI and its representatives against any damages arising out of the use of any TI components in safety-critical applications.

In some cases, TI components may be promoted specifically to facilitate safety-related applications. With such components, TI's goal is to help enable customers to design and create their own end-product solutions that meet applicable functional safety standards and requirements. Nonetheless, such components are subject to these terms.

No TI components are authorized for use in FDA Class III (or similar life-critical medical equipment) unless authorized officers of the parties have executed a special agreement specifically governing such use.

Only those TI components which TI has specifically designated as military grade or "enhanced plastic" are designed and intended for use in military/aerospace applications or environments. Buyer acknowledges and agrees that any military or aerospace use of TI components which have **not** been so designated is solely at the Buyer's risk, and that Buyer is solely responsible for compliance with all legal and regulatory requirements in connection with such use.

TI has specifically designated certain components as meeting ISO/TS16949 requirements, mainly for automotive use. In any case of use of non-designated products, TI will not be responsible for any failure to meet ISO/TS16949.

### Products

Audio	<a href="http://www.ti.com/audio">www.ti.com/audio</a>
Amplifiers	<a href="http://amplifier.ti.com">amplifier.ti.com</a>
Data Converters	<a href="http://dataconverter.ti.com">dataconverter.ti.com</a>
DLP® Products	<a href="http://www.dlp.com">www.dlp.com</a>
DSP	<a href="http://dsp.ti.com">dsp.ti.com</a>
Clocks and Timers	<a href="http://www.ti.com/clocks">www.ti.com/clocks</a>
Interface	<a href="http://interface.ti.com">interface.ti.com</a>
Logic	<a href="http://logic.ti.com">logic.ti.com</a>
Power Mgmt	<a href="http://power.ti.com">power.ti.com</a>
Microcontrollers	<a href="http://microcontroller.ti.com">microcontroller.ti.com</a>
RFID	<a href="http://www.ti-rfid.com">www.ti-rfid.com</a>
OMAP Applications Processors	<a href="http://www.ti.com/omap">www.ti.com/omap</a>
Wireless Connectivity	<a href="http://www.ti.com/wirelessconnectivity">www.ti.com/wirelessconnectivity</a>

### Applications

Automotive and Transportation	<a href="http://www.ti.com/automotive">www.ti.com/automotive</a>
Communications and Telecom	<a href="http://www.ti.com/communications">www.ti.com/communications</a>
Computers and Peripherals	<a href="http://www.ti.com/computers">www.ti.com/computers</a>
Consumer Electronics	<a href="http://www.ti.com/consumer-apps">www.ti.com/consumer-apps</a>
Energy and Lighting	<a href="http://www.ti.com/energy">www.ti.com/energy</a>
Industrial	<a href="http://www.ti.com/industrial">www.ti.com/industrial</a>
Medical	<a href="http://www.ti.com/medical">www.ti.com/medical</a>
Security	<a href="http://www.ti.com/security">www.ti.com/security</a>
Space, Avionics and Defense	<a href="http://www.ti.com/space-avionics-defense">www.ti.com/space-avionics-defense</a>
Video and Imaging	<a href="http://www.ti.com/video">www.ti.com/video</a>

### TI E2E Community

[e2e.ti.com](http://e2e.ti.com)