

## 350mA Dual Rail Linear Regulator

Check for Samples: [LP5952](#)

### FEATURES

- Excellent load transient response:  $\pm 15\text{mV}$  typical
- Excellent line transient response:  $\pm 1\text{mV}$  typical
- $0.7\text{V} \leq V_{\text{IN}} \leq 4.5\text{V}$
- $2.5\text{V} \leq V_{\text{BATT}} \leq 5.5\text{V}$
- $0.5\text{V} \leq V_{\text{OUT}} \leq 2.0\text{V}$
- For  $I_{\text{LOAD}} = 350\text{mA}$ :
  - $V_{\text{BATT}} \geq V_{\text{OUT(NOM)}} + 1.5\text{V}$  or  $2.5\text{V}$  whichever is higher
- For  $I_{\text{LOAD}} = 150\text{mA}$ :
  - $V_{\text{BATT}} \geq V_{\text{OUT(NOM)}} + 1.3\text{V}$  or  $2.5\text{V}$  whichever is higher
- $50\mu\text{A}$  typical quiescent current from  $V_{\text{BATT}}$
- $10\mu\text{A}$  typical quiescent current from  $V_{\text{IN}}$
- $0.1\mu\text{A}$  typical quiescent current in shutdown
- Ensured  $350\text{mA}$  output current
- Noise voltage =  $100\mu\text{V}_{\text{RMS}}$  typical
- Operates from a single Li-Ion cell or 3 cell NiMH/NiCd batteries
- Only one or two tiny surface-mount external components required depending on application
- Small, thin 5-bump DSBGA package and 6-pin Chip On Lead USON package, lead free
- Thermal-overload and short-circuit protection
- $-40^\circ\text{C}$  to  $+125^\circ\text{C}$  junction temperature range

### APPLICATIONS

- Mobile Phones
- Hand-Held Radios
- Personal Digital Assistants
- Palm-Top PCs
- Portable Instruments
- Battery Powered Devices

### DESCRIPTION

The LP5952 is a Dual Supply Rail Linear Regulator optimized for powering ultra-low voltage circuits from a single Li-Ion cell or 3 cell NiMH/NiCd batteries.

In the typical post regulation application  $V_{\text{BATT}}$  is directly connected to the battery (range  $2.5\text{V} \dots 5.5\text{V}$ ) and  $V_{\text{IN}}$  is supplied by the output voltage of the DC-DC Converter (range  $0.7\text{V} \dots 4.5\text{V}$ ).

The device offers superior dropout and transient features combined with very low quiescent currents. In shutdown mode (Enable pin pulled low) the device turns off and reduces battery consumption to  $0.1\mu\text{A}$  (typ.).

The LP5952 also features internal protection against over-temperature, over-current and under-voltage conditions.

Performance is specified for a  $-40^\circ\text{C}$  to  $125^\circ\text{C}$  junction temperature range.

### Typical Application Circuit

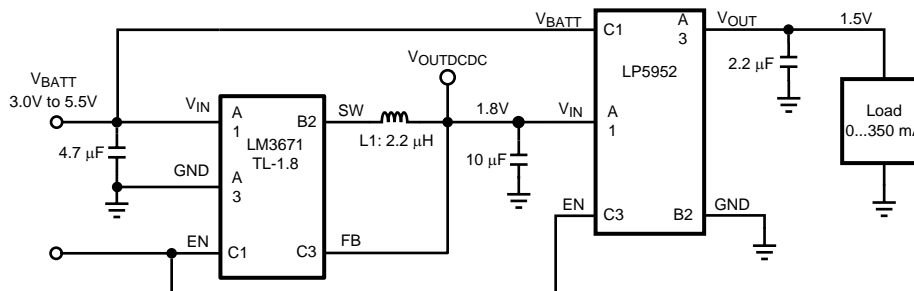

Figure 1. Typical Application Circuit with DC-DC Converter as Pre-Regulator for  $V_{\text{IN}}$



Please be aware that an important notice concerning availability, standard warranty, and use in critical applications of Texas Instruments semiconductor products and disclaimers thereto appears at the end of this data sheet.

All trademarks are the property of their respective owners.

**DESCRIPTION (CONTINUED)**

The device is available in a tiny 5-bump DSBGA and a 6-pin Chip On Lead USON package, lead free.

The device is available in fixed output voltages in the range of 0.5V to 2.0V. For availability, please contact your local Texas Instruments sales office.

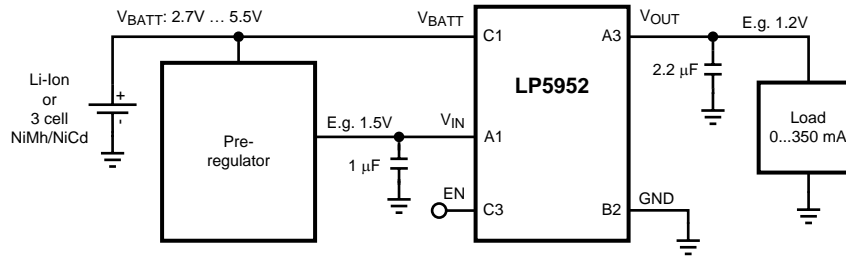

**Figure 2. Typical Application Circuit**

**Connection Diagram**

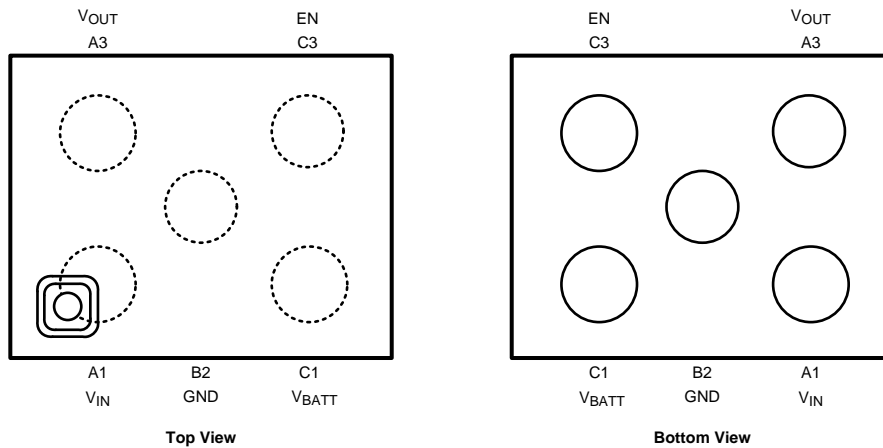

**Figure 3. 5-Bump Thin DSBGA Package, Large Bump, 0.5mm Pitch  
See Package Number YZR0005**

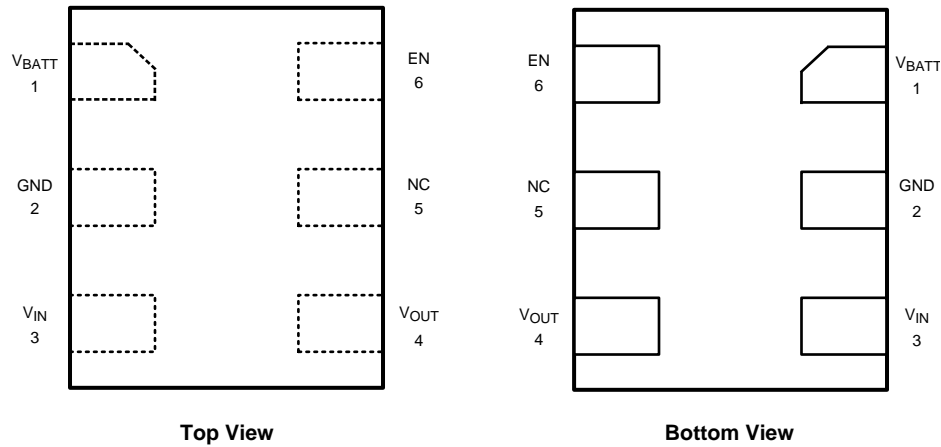

Figure 4. 6-Pin Chip On Lead USON package, 0.5mm pitch  
See Package Number NKH0006B

PIN DESCRIPTIONS

| Pin Number DSBGA | Pin Number USON | Pin Name   | Description  |
|------------------|-----------------|------------|--|
| A1               | 3               | $V_{IN}$   | Power input voltage; input range: 0.7V to 4.5V, $V_{IN} \leq V_{BATT}$   |
| A3               | 4               | $V_{OUT}$  | Regulated output voltage   |
| B2               | 2               | GND        | Ground   |
| C1               | 1               | $V_{BATT}$ | Bias input voltage; input range: 2.5V to 5.5V  |
| C3               | 6               | EN         | Enable pin logic input: low = shutdown, high = active, normal operation. This pin should not be left floating. Tie to $V_{BATT}$ if this function is not used. |
|                  | 5               | NC         | Do not make connections to this pin  |



These devices have limited built-in ESD protection. The leads should be shorted together or the device placed in conductive foam during storage or handling to prevent electrostatic damage to the MOS gates.

### Absolute Maximum Ratings<sup>(1)(2)(3)</sup>

|  |                    |       |
|--|--------------------|-------|
| $V_{IN}$ , $V_{BATT}$ pins: Voltage to GND, $V_{IN} \leq V_{BATT}$   | -0.2V to 6.0V      |       |
| $V_{BATT}$ pin to $V_{IN}$ pin                                       | 0.2V               |       |
| EN pin, Voltage to GND   | -0.2V to 6.0V      |       |
| Continuous Power Dissipation <sup>(4)</sup>                          | Internally Limited |       |
| Junction Temperature ( $T_{J-MAX}$ )                                 | 150°C              |       |
| Storage Temperature Range  | -65°C to + 150°C   |       |
| Package Peak Reflow Temperature (Pb-free, 10-20 sec.) <sup>(5)</sup> | 260°C              |       |
| ESD Rating <sup>(6)</sup>  | Human Body Mode    | 2.0kV |
|  | Machine Model      | 200V  |

- (1) Absolute Maximum Ratings indicate limits beyond which damage to the component may occur. Operating Ratings are conditions under which operation of the device is ensured. Operating Ratings do not imply ensured performance limits. For ensured performance limits and associated test conditions, see the Electrical Characteristics tables.
- (2) All voltages are with respect to the potential at the GND pin.
- (3) If Military/Aerospace specified devices are required, please contact the Texas Instruments Sales Office/ Distributors for availability and specifications.
- (4) Internal thermal shutdown circuitry protects the device from permanent damage. Thermal shutdown engages at  $T_J = 165^\circ\text{C}$  (typ.) and disengages at  $T_J = 145^\circ\text{C}$  (typ.).
- (5) For detailed soldering specifications and information, please refer to Application Note 1112: DSBGA Wafer Level Chip Scale Package (SNVA009) and Application Note 1187: Leadless Leadframe Package (LLP) (SNOA401).
- (6) The Human body model is a 100pF capacitor discharged through a 1.5k $\Omega$  resistor into each pin. The machine model is a 200pF capacitor discharged directly into each pin. (MIL-STD-883 3015.7)

### Operating Ratings

|  |                  |
|--|------------------|
| Input Voltage Range $V_{IN}$                       | 0.7V to 4.5V     |
| Input Voltage Range $V_{BATT}$                     | 2.5V to 5.5V     |
| $V_{EN}$ Input Voltage                             | 0 to $V_{BATT}$  |
| Recommended Load Current                           | 0mA to 350mA     |
| Junction Temperature ( $T_J$ ) Range               | -40°C to + 125°C |
| Ambient Temperature ( $T_A$ ) Range <sup>(1)</sup> | -40°C to + 85°C  |

- (1) In applications where high power dissipation and/or poor package thermal resistance is present, the maximum ambient temperature may have to be derated. Maximum ambient temperature ( $T_{A-MAX}$ ) is dependent on the maximum operating junction temperature ( $T_{J-MAX-OP} = 125^\circ\text{C}$ ), the maximum power dissipation of the device in the application ( $P_{D-MAX}$ ), and the junction-to ambient thermal resistance of the part/package in the application ( $\theta_{JA}$ ), as given by the following equation:  $T_{A-MAX} = T_{J-MAX-OP} - (\theta_{JA} \times P_{D-MAX})$ .

### Thermal Properties

|   |         |
|---|---------|
| Junction-to-Ambient Thermal Resistance( $\theta_{JA}$ ) |         |
| YZR0005 package <sup>(1)</sup>                          | 95°C/W  |
| NKH0006B package <sup>(1)</sup>                         | 150°C/W |

- (1) Junction-to-ambient thermal resistance is highly application and board-layout dependent. In applications where high maximum power dissipation exists, special attention must be paid to thermal dissipation issues in board design.

**Electrical Characteristics**<sup>(1)(2)(3)</sup>

Typical values and limits appearing in standard typeface are for  $T_A = 25^\circ\text{C}$ . Limits appearing in **boldface** type apply over the full operating temperature range:  $-40^\circ\text{C} \leq T_J \leq +125^\circ\text{C}$ . Unless otherwise noted, specifications apply to the typical application circuit with  $V_{IN} = V_{OUT(NOM)} + 1.0\text{V}$ ,  $V_{BATT} = V_{OUT(NOM)} + 1.5\text{V}$  or  $2.5\text{V}$ , whichever is higher,  $I_{OUT} = 1\text{mA}$ ,  $C_{VIN} = 1.0\mu\text{F}$ ,  $C_{OUT} = 2.2\mu\text{F}$ ,  $V_{EN} = V_{BATT}$ .

| Symbol                              | Parameter  | Condition  | Typ  | Limit               |                   | Units                   |  |
|-------------------------------------|--|--|------|---------------------|-------------------|-------------------------|--|
|                                     |  |  |      | Min                 | Max               |                         |  |
| $\Delta V_{OUT} / V_{OUT}$          | Output Voltage Tolerance                         | $V_{IN} = V_{OUT(NOM)} + 0.3\text{V}$  |      | -1.5<br><b>-2.0</b> | 1.5<br><b>2.0</b> | %<br>%                  |  |
| $\Delta V_{OUT} / \Delta V_{IN}$    | Line Regulation Error                            | $V_{IN} = V_{OUT(NOM)} + 0.3\text{V}$ to $4.5\text{V}$ , $V_{BATT} = 4.5\text{V}$                    | 0.3  |                     | <b>1.0</b>        | mV/V                    |  |
| $\Delta V_{OUT} / \Delta V_{BATT}$  |  | $V_{BATT} = V_{OUT(NOM)} + 1.5\text{V}$ ( $\geq 2.5\text{V}$ ) to $5.5\text{V}$                      | 0.5  |                     | <b>2.2</b>        |                         |  |
| $\Delta V_{OUT} / \Delta \text{mA}$ | Load Regulation Error                            | $I_{OUT} = 1\text{mA}$ to $350\text{mA}$ , DSBGA package   | 15   |                     | <b>30</b>         | $\mu\text{V}/\text{mA}$ |  |
|                                     |  | $I_{OUT} = 1\text{mA}$ to $350\text{mA}$ , USON-6 package  | 43   |                     | <b>60</b>         | $\mu\text{V}/\text{mA}$ |  |
| $I_{SC}$                            | Output Current (short circuit)                   | $V_{OUT} = 0\text{V}$ , $V_{EN} = V_{IN} = V_{BATT} = V_{OUT(NOM)} + 1.5\text{V}$                    | 500  | <b>350</b>          |                   | mA                      |  |
| $V_{DO\_VBATT}$ <sup>(4)</sup>      | Output Voltage Dropout $V_{BATT}$ <sup>(5)</sup> | $I_{OUT} = 350\text{mA}$ , $V_{IN} = V_{OUT(NOM)} + 0.3\text{V}$ , DSBGA package                     | 1.07 |                     | <b>1.5</b>        | V                       |  |
|                                     |  | $I_{OUT} = 350\text{mA}$ , $V_{IN} = V_{OUT(NOM)} + 0.3\text{V}$ , USON-6 package                    | 1.08 |                     | <b>1.5</b>        | V                       |  |
|                                     |  | $I_{OUT} = 150\text{mA}$ , $V_{IN} = V_{OUT(NOM)} + 0.3\text{V}$ , DSBGA package                     | 0.96 |                     | <b>1.3</b>        | V                       |  |
|                                     |  | $I_{OUT} = 150\text{mA}$ , $V_{IN} = V_{OUT(NOM)} + 0.3\text{V}$ , USON-6 package                    | 0.97 |                     | <b>1.3</b>        | V                       |  |
| $V_{DO\_VIN}$                       | Output Voltage Dropout $V_{IN}$                  | $I_{OUT} = 350\text{mA}$ , $V_{BATT} = V_{OUT(NOM)} + 1.5\text{V}$ or $2.5\text{V}$ , DSBGA package  | 88   |                     | <b>200</b>        | mV                      |  |
|                                     |  | $I_{OUT} = 350\text{mA}$ , $V_{BATT} = V_{OUT(NOM)} + 1.5\text{V}$ or $2.5\text{V}$ , USON-6 package | 128  |                     | <b>250</b>        | mV                      |  |
| $E_N$                               | Output Noise                                     | 10Hz to 100kHz   | 100  |                     |                   | $\mu\text{V}_{RMS}$     |  |
| PSRR                                | Power Supply Rejection Ratio                     | Sine modulated $V_{BATT}$  |      |                     |                   |                         |  |
|                                     |  | $f = 10\text{Hz}$  | 70   |                     |                   | dB                      |  |
|                                     |  | $f = 100\text{Hz}$   | 65   |                     |                   | dB                      |  |
|                                     |  | $f = 1\text{kHz}$  | 45   |                     |                   | dB                      |  |
|                                     |  | Sine modulated $V_{IN}$  |      |                     |                   |                         |  |
|                                     |  | $f = 10\text{Hz}$  | 80   |                     |                   | dB                      |  |
| $f = 100\text{Hz}$                  | 90   |  |      | dB                  |                   |                         |  |
| $f = 1\text{kHz}$                   | 95   |  |      | dB                  |                   |                         |  |
| $f = 10\text{kHz}$                  | 85   |  |      | dB                  |                   |                         |  |
| $f = 100\text{kHz}$                 | 64   |  |      | dB                  |                   |                         |  |

- (1) All voltages are with respect to the potential at the GND pin.
- (2) Min and Max limits are ensured by design, test, or statistical analysis. Typical (Typ) numbers are not ensured, but do represent the most likely norm. Unless otherwise specified, conditions for Typ specifications are:  $V_{IN} = V_{OUT(NOM)} + 1.0\text{V}$ ,  $V_{BATT} = V_{OUT(NOM)} + 1.5\text{V}$  or  $2.5\text{V}$ , whichever is higher,  $T_A = 25^\circ\text{C}$ .
- (3)  $V_{OUT(NOM)}$  is the stated output voltage option
- (4) This specification does not apply if the battery voltage  $V_{BATT}$  needs to be decreased below the minimum operating limit of  $2.5\text{V}$  during this test.
- (5) Dropout voltage is defined as the input to output voltage differential at which the output voltage falls to  $100\text{mV}$  below the nominal output voltage.

### Electrical Characteristics Quiescent Currents<sup>(1)(2)(3)</sup>

| Symbol         | Parameter               | Condition                         | Typ | Limit |     | Units         |
|----------------|-------------------------|-----------------------------------|-----|-------|-----|---------------|
|                |                         |                                   |     | Min   | Max |               |
| $I_{Q\_VBATT}$ | Current into $V_{BATT}$ | $I_{LOAD} = 0 \dots 350\text{mA}$ | 50  |       | 100 | $\mu\text{A}$ |
| $I_{Q\_VIN}$   | Current into $V_{IN}$   | $I_{LOAD} = 0$                    | 11  |       | 28  | $\mu\text{A}$ |

- (1) All voltages are with respect to the potential at the GND pin.
- (2) Min and Max limits are ensured by design, test, or statistical analysis. Typical (Typ) numbers are not ensured, but do represent the most likely norm. Unless otherwise specified, conditions for Typ specifications are:  $V_{IN} = V_{OUT(NOM)} + 1.0\text{V}$ ,  $V_{BATT} = V_{OUT(NOM)} + 1.5\text{V}$  or  $2.5\text{V}$ , whichever is higher,  $T_A = 25^\circ\text{C}$ .
- (3)  $V_{OUT(NOM)}$  is the stated output voltage option

### Electrical Characteristics Shutdown Currents<sup>(1)(2)(3)</sup>

| Symbol         | Parameter               | Condition            | Typ | Limit |     | Units         |
|----------------|-------------------------|----------------------|-----|-------|-----|---------------|
|                |                         |                      |     | Min   | Max |               |
| $I_{Q\_VBATT}$ | Current into $V_{BATT}$ | $V_{EN} = 0\text{V}$ | 0.1 |       | 1   | $\mu\text{A}$ |
| $I_{Q\_VIN}$   | Current into $V_{IN}$   | $V_{EN} = 0\text{V}$ | 0.1 |       | 1   | $\mu\text{A}$ |

- (1) All voltages are with respect to the potential at the GND pin.
- (2) Min and Max limits are ensured by design, test, or statistical analysis. Typical (Typ) numbers are not ensured, but do represent the most likely norm. Unless otherwise specified, conditions for Typ specifications are:  $V_{IN} = V_{OUT(NOM)} + 1.0\text{V}$ ,  $V_{BATT} = V_{OUT(NOM)} + 1.5\text{V}$  or  $2.5\text{V}$ , whichever is higher,  $T_A = 25^\circ\text{C}$ .
- (3)  $V_{OUT(NOM)}$  is the stated output voltage option

### Electrical Characteristics Enable Control Characteristics<sup>(1)(2)(3)</sup>

| Symbol   | Parameter                               | Conditions | Typ  | Limit |     | Units         |
|----------|---|------------|------|-------|-----|---------------|
|          |   |            |      | Min   | Max |               |
| $I_{EN}$ | Maximum Input Current at $V_{EN}$ Input |            | 0.01 |       | 1   | $\mu\text{A}$ |
| $V_{IL}$ | Low Input Threshold (shutdown)          |            |      |       | 0.4 | V             |
| $V_{IH}$ | High Input Threshold (enable)           |            |      | 1.0   |     | V             |

- (1) All voltages are with respect to the potential at the GND pin.
- (2) Min and Max limits are ensured by design, test, or statistical analysis. Typical (Typ) numbers are not ensured, but do represent the most likely norm. Unless otherwise specified, conditions for Typ specifications are:  $V_{IN} = V_{OUT(NOM)} + 1.0\text{V}$ ,  $V_{BATT} = V_{OUT(NOM)} + 1.5\text{V}$  or  $2.5\text{V}$ , whichever is higher,  $T_A = 25^\circ\text{C}$ .
- (3)  $V_{OUT(NOM)}$  is the stated output voltage option

### Electrical Characteristics Thermal Protection<sup>(1)(2)(3)</sup>

| Symbol            | Parameter                    | Conditions | Typ | Limit |     | Units            |
|-------------------|------------------------------|------------|-----|-------|-----|------------------|
|                   |                              |            |     | Min   | Max |                  |
| $T_{SHDN}$        | Thermal-Shutdown Temperature |            | 165 |       |     | $^\circ\text{C}$ |
| $\Delta T_{SHDN}$ | Thermal-Shutdown Hysteresis  |            | 20  |       |     | $^\circ\text{C}$ |

- (1) All voltages are with respect to the potential at the GND pin.
- (2)  $V_{OUT(NOM)}$  is the stated output voltage option
- (3) Min and Max limits are ensured by design, test, or statistical analysis. Typical (Typ) numbers are not ensured, but do represent the most likely norm. Unless otherwise specified, conditions for Typ specifications are:  $V_{IN} = V_{OUT(NOM)} + 1.0\text{V}$ ,  $V_{BATT} = V_{OUT(NOM)} + 1.5\text{V}$  or  $2.5\text{V}$ , whichever is higher,  $T_A = 25^\circ\text{C}$ .

**Electrical Characteristics Transient Characteristics<sup>(1)(2)(3)</sup>**

| Symbol           | Parameter                                  | Conditions  | Typ      | Limit |            | Units   |
|------------------|--|---|----------|-------|------------|---------|
|                  |  |   |          | Min   | Max        |         |
| $\Delta V_{OUT}$ | Dynamic Line Transient Response $V_{IN}$   | $V_{IN} = V_{OUT(NOM)} + 0.3V$ to $V_{OUT(NOM)} + 0.9V$ ; tr, tf = 10 $\mu$ s   | $\pm 1$  |       |            | mV      |
| $\Delta V_{OUT}$ | Dynamic Line Transient Response $V_{BATT}$ | $V_{BATT} = V_{OUT(NOM)} + 1.5V$ to $V_{OUT(NOM)} + 2.1V$ ; tr, tf = 10 $\mu$ s | $\pm 15$ |       |            | mV      |
| $\Delta V_{OUT}$ | Dynamic Load Transient Response            | Pulsed load 0 ...300mA, di/dt = 300mA/1 $\mu$ s DSBGA package                   | $\pm 15$ |       |            | mV      |
|                  |  | Pulsed load 0 ...300mA, di/dt = 300mA/1 $\mu$ s USON-6 package                  | -35/+15  |       |            | mV      |
| $T_{STARTUP}$    | Startup Time                               | EN to 0.95 * $V_{OUT}$  | 70       |       | <b>150</b> | $\mu$ s |

- (1) All voltages are with respect to the potential at the GND pin.
- (2)  $V_{OUT(NOM)}$  is the stated output voltage option
- (3) Min and Max limits are ensured by design, test, or statistical analysis. Typical (Typ) numbers are not ensured, but do represent the most likely norm. Unless otherwise specified, conditions for Typ specifications are:  $V_{IN} = V_{OUT(NOM)} + 1.0V$ ,  $V_{BATT} = V_{OUT(NOM)} + 1.5V$  or 2.5V, whichever is higher,  $T_A = 25^\circ C$ .

**Electrical Characteristics Input and Output Capacitors, Recommended Specification<sup>(1)(2)(3)</sup>**

| Symbol    | Parameter                     | Conditions   | Nom | Limit |     | Units      |
|-----------|-------------------------------|--|-----|-------|-----|------------|
|           |                               |  |     | Min   | Max |            |
| $C_{OUT}$ | Output Capacitance            | Capacitance <sup>(4)</sup>   | 2.2 | 1.5   | 10  | $\mu$ F    |
|           |                               | ESR  |     | 3     | 300 | m $\Omega$ |
| $C_{VIN}$ | Input Capacitance at $V_{IN}$ | Capacitance <sup>(4)</sup> , not needed in typ post regulation application, see Figure 1 | 1   | 0.47  |     | $\mu$ F    |
|           |                               | ESR  |     | 3     | 300 | m $\Omega$ |

- (1) All voltages are with respect to the potential at the GND pin.
- (2) Min and Max limits are ensured by design, test, or statistical analysis. Typical (Typ) numbers are not ensured, but do represent the most likely norm. Unless otherwise specified, conditions for Typ specifications are:  $V_{IN} = V_{OUT(NOM)} + 1.0V$ ,  $V_{BATT} = V_{OUT(NOM)} + 1.5V$  or 2.5V, whichever is higher,  $T_A = 25^\circ C$ .
- (3)  $V_{OUT(NOM)}$  is the stated output voltage option
- (4) The capacitor tolerance should be 30% or better over temperature. The full operating conditions for the application should be considered when selecting a suitable capacitor to ensure that the minimum value of capacitance is always met. Recommended capacitor type is X7R. However, dependent on application, X5R, Y5V, and Z5U can also be used. The shown minimum limit represents real minimum capacitance, including all tolerances and must be maintained over temperature and dc bias voltage (See capacitor section in Applications Hints)

**BLOCK DIAGRAM**

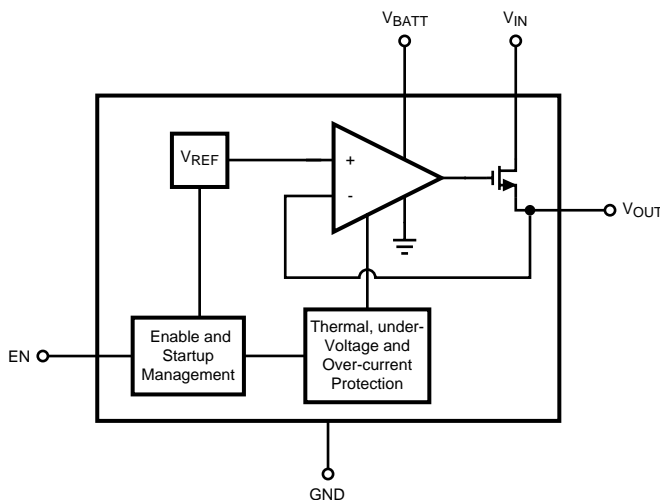

### Typical Performance Characteristics

Unless otherwise specified,  $C_{IN} = 1.0\mu\text{F}$  ceramic,  $C_{OUT} = 2.2\mu\text{F}$  ceramic,  $V_{IN} = V_{OUT(NOM)} + 1\text{V}$ ,  $V_{BATT} = V_{OUT(NOM)} + 1.5\text{V}$ ,  $T_A = 25^\circ\text{C}$ , Enable pin is tied to  $V_{BATT}$ . DSBGA package.

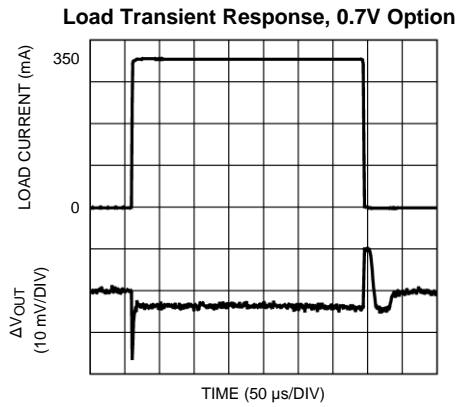

Figure 5.

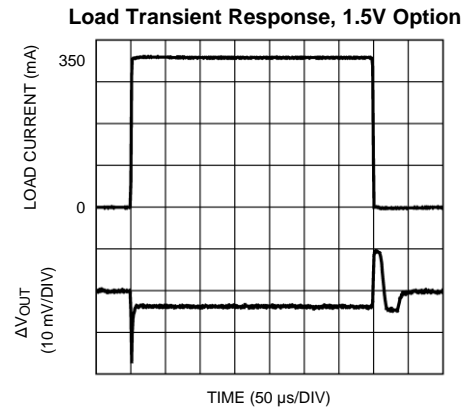

Figure 6.

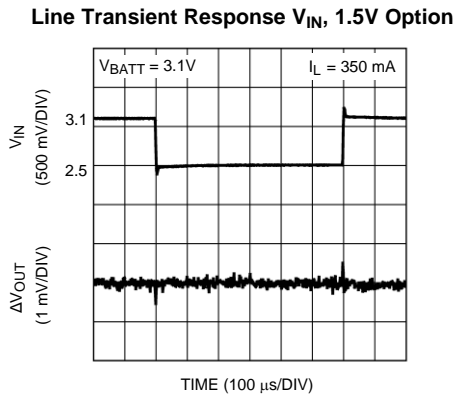

Figure 7.

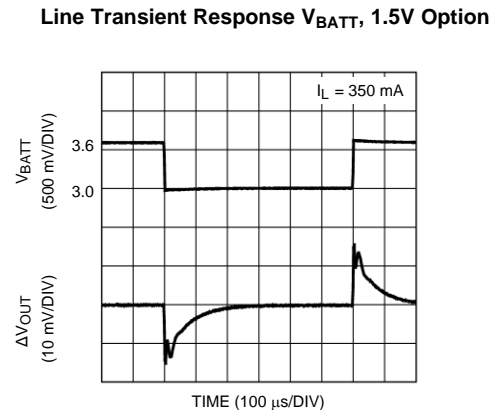

Figure 8.

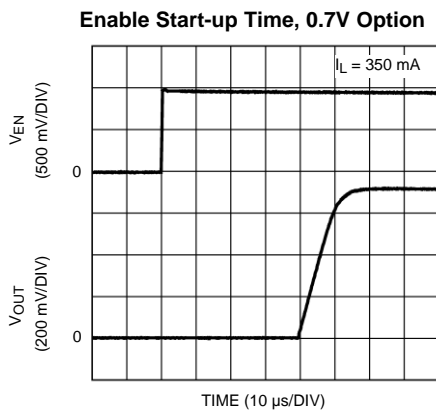

Figure 9.

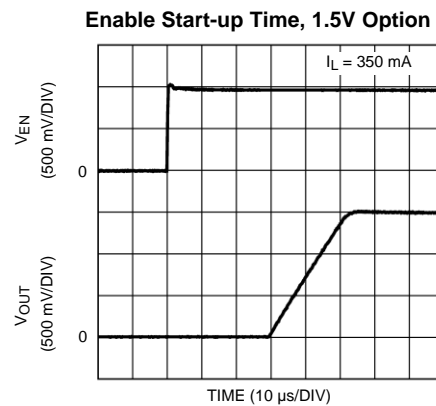

Figure 10.



### Typical Performance Characteristics (continued)

Unless otherwise specified,  $C_{IN} = 1.0\mu\text{F}$  ceramic,  $C_{OUT} = 2.2\mu\text{F}$  ceramic,  $V_{IN} = V_{OUT(NOM)} + 1\text{V}$ ,  $V_{BATT} = V_{OUT(NOM)} + 1.5\text{V}$ ,  $T_A = 25^\circ\text{C}$ , Enable pin is tied to  $V_{BATT}$ . DSBGA package.

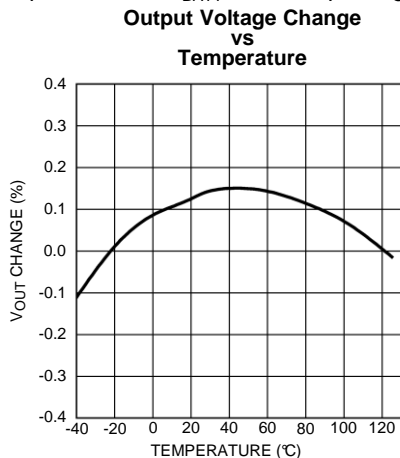

Figure 11.

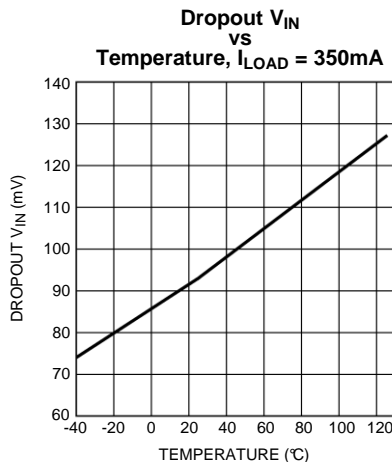

Figure 12.

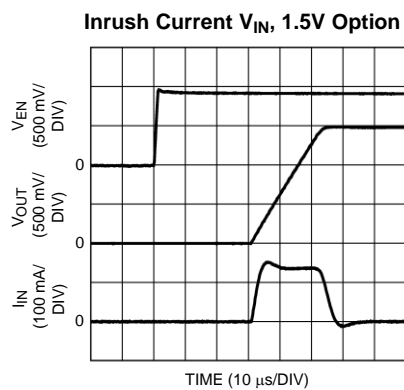

Figure 13.

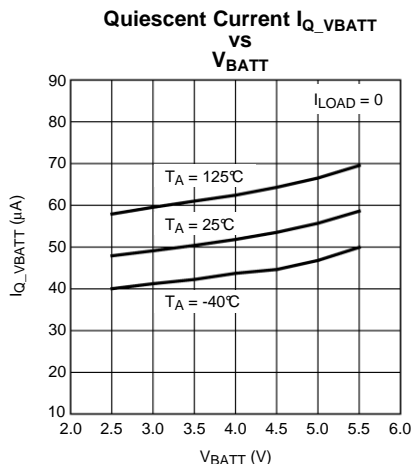

Figure 14.

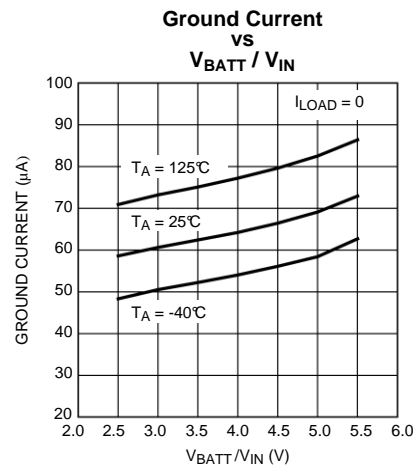

Figure 15.

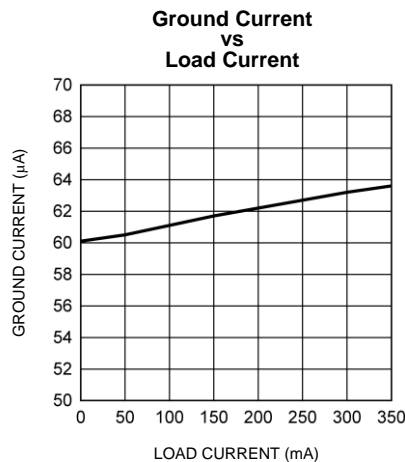
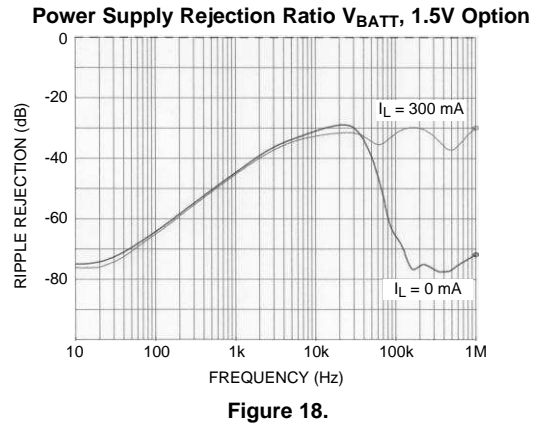
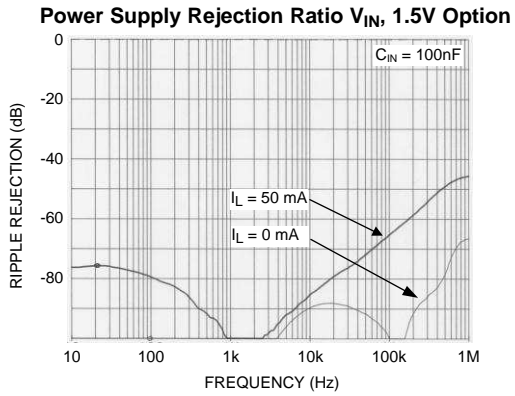

Figure 16.

**Typical Performance Characteristics (continued)**

Unless otherwise specified,  $C_{IN} = 1.0\mu\text{F}$  ceramic,  $C_{OUT} = 2.2\mu\text{F}$  ceramic,  $V_{IN} = V_{OUT(NOM)} + 1\text{V}$ ,  $V_{BATT} = V_{OUT(NOM)} + 1.5\text{V}$ ,  $T_A = 25^\circ\text{C}$ , Enable pin is tied to  $V_{BATT}$ . DSBGA package.



## APPLICATION HINTS

### DUAL RAIL SUPPLY

The LP5952 requires two different supply voltages:

- $V_{IN}$ , the power input voltage, is regulated to the fixed output voltage
- $V_{BATT}$ , the bias input voltage, supplies internal circuitry.

It's important that  $V_{IN}$  does not exceed  $V_{BATT}$  at any time. If the device is used in the typical post regulation application as shown in [Figure 1](#), the sequencing of the two power supplies is not an issue as  $V_{BATT}$  supplies both, the DC-DC regulator and the LP5952. The output voltage of the DC-DC regulator will take some time to rise up and supply  $V_{IN}$  of LP5952. In this application  $V_{IN}$  will always ramp up more slowly than  $V_{BATT}$ .

In case  $V_{IN}$  is shorted to  $V_{BATT}$ , the voltages at the two supply pins will ramp up simultaneously causing no problem.

Only in applications with two independent supplies connected to the LP5952 special care must be taken to ensure that  $V_{IN}$  is always  $\leq V_{BATT}$ .

### POWER DISSIPATION AND DEVICE OPERATION

The permissible power dissipation for any package is a measure of the capability of the device to pass heat from the power source, the junctions of the IC, to the ultimate heat sink, the ambient environment. Thus the power dissipation is dependent on the ambient temperature and the thermal resistance across the various interfaces between the die and ambient air.

As stated in the electrical specification section, the allowable power dissipation for the device in a given package can be calculated using the equation:

$$P_D = (T_{J(MAX)} - T_A) / \theta_{JA} \quad (1)$$

With a  $\theta_{JA} = 95^\circ\text{C/W}$ , the device in the 5 bump DSBGA package returns a value of 1053mW with a maximum junction temperature of  $125^\circ\text{C}$  at  $T_A$  of  $25^\circ\text{C}$  or 421mW at  $T_A$  of  $85^\circ\text{C}$ .

The actual power dissipation across the device can be estimated by the following equation:

$$P_D = (V_{IN} - V_{OUT}) * I_{OUT} \quad (2)$$

This establishes the relationship between the power dissipation allowed due to thermal consideration, the voltage drop across the device, and the continuous current capability of the device. These two equations should be used to determine the optimum operating conditions for the device in the application. As an example, to keep full load current capability of 350mA for a 1.5V output voltage option at a high ambient temperature of  $85^\circ\text{C}$ ,  $V_{IN}$  has to be kept  $\leq 2.7\text{V}$  (for DSBGA package):

$$V_{IN} \leq P_D / I_{OUT} + V_{OUT} = 421\text{mW} / 350\text{mA} + 1.5\text{V} = 2.7\text{V}. \quad (3)$$

Figure 19 shows the output current derating due to these considerations:

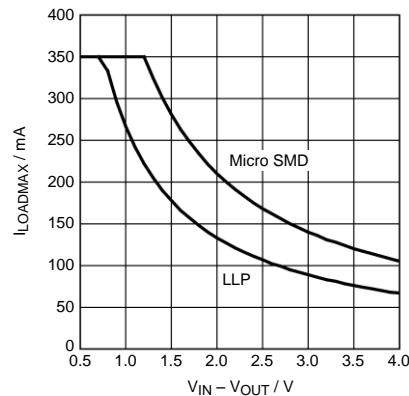

**Figure 19. Maximum Load Current vs  $V_{IN} - V_{OUT}$ ,  $T_A = 85^\circ\text{C}$ ,  $V_{OUT} = 1.5\text{V}$ ,  $\theta_{JA(\text{DSBGA})} = 95^\circ\text{C/W}$ ,  $\theta_{JA(\text{USON})} = 150^\circ\text{C/W}$ ,**

The typical contribution of the bias input voltage supply  $V_{BATT}$  to the power dissipation can be neglected:

$$P_{D\_VBATT} = V_{BATT} * I_{QVBATT} = 5.5\text{V} * 50\mu\text{A} = 0.275\text{mW typical.} \quad (4)$$

## EXTERNAL CAPACITORS

As is common with most regulators, the LP5952 requires external capacitors to ensure stable operation. The LP5952 is specifically designed for portable applications requiring minimum board space and the smallest size components. These capacitors must be correctly selected for good performance.

### INPUT CAPACITOR

If the LP5952 is used stand alone, an input capacitor at  $V_{IN}$  is required for stability. It is recommended that a  $1.0\mu\text{F}$  capacitor be connected between the LP5952 power voltage input pin  $V_{IN}$  and ground (this capacitance value may be increased without limit).

This capacitor must be located a distance of not more than 1 cm from the  $V_{IN}$  pin and returned to a clean analogue ground. Any good quality ceramic, tantalum, or film capacitor may be used at the input.

A capacitor at  $V_{BATT}$  is not required if the distance to the supply does not exceed 5cm.

If the device is used in the typical application as post regulator after a DC-DC regulator, no input capacitors are required at all as the capacitors of the DC-DC regulator ( $C_{IN}$  and  $C_{OUT}$ ) are sufficient if both components are mounted close to each other and a proper GND plane is used. If the distance between the output capacitor of the DC-DC regulator and the  $V_{IN}$  pin of the LP5952 is larger than 5cm, it's recommended to add the mentioned input capacitor at  $V_{IN}$ .

**Important:** Tantalum capacitors can suffer catastrophic failures due to surge current when connected to a low-impedance source of power (like a battery or a very large capacitor). If a tantalum capacitor is used at the input, it must be ensured by the manufacturer to have a surge current rating sufficient for the application.

The ESR (Equivalent Series Resistance) of the input capacitor should be in the range of  $3\text{m}\Omega$  to  $300\text{m}\Omega$ . The tolerance and temperature coefficient must be considered when selecting the capacitor to ensure the capacitance will remain  $\geq 470\text{nF}$  over the entire operating temperature range.

### OUTPUT CAPACITOR

The LP5952 is designed specifically to work with very small ceramic output capacitors. A ceramic capacitor (dielectric types X7R, Z5U, or Y5V) in the  $2.2\mu\text{F}$  range (up to  $10\mu\text{F}$ ) and with an ESR between  $3\text{m}\Omega$  to  $300\text{m}\Omega$  is suitable as  $C_{OUT}$  in the LP5952 application circuit.

This capacitor must be located a distance of not more than 1cm from the  $V_{OUT}$  pin and returned to a clean analogue ground.

It is also possible to use tantalum or film capacitors at the device output,  $V_{OUT}$ , but these are not as attractive for reasons of size and cost (see the section Capacitor Characteristics).

## CAPACITOR CHARACTERISTICS

The LP5952 is designed to work with ceramic capacitors on the output to take advantage of the benefits they offer. For capacitance values in the range of  $1\mu\text{F}$  to  $4.7\mu\text{F}$ , ceramic capacitors are the smallest, least expensive and have the lowest ESR values, thus making them best for eliminating high frequency noise. The ESR of a typical  $1\mu\text{F}$  ceramic capacitor is in the range of  $3\text{m}\Omega$  to  $40\text{m}\Omega$ , which easily meets the ESR requirement for stability for the LP5952.

For both input and output capacitors, careful interpretation of the capacitor specification is required to ensure correct device operation. The capacitor value can change greatly, depending on the operating conditions and capacitor type.

In particular, the output capacitor selection should take account of all the capacitor parameters, to ensure that the specification is met within the application. The capacitance can vary with DC bias conditions as well as temperature and frequency of operation. Capacitor values will also show some decrease over time due to aging. The capacitor parameters are also dependant on the particular case size, with smaller sizes giving poorer performance figures in general. The example shows a typical graph comparing different capacitor case sizes in a Capacitance vs. DC Bias plot. As shown in the graph, increasing the DC Bias condition can result in the capacitance value falling below the minimum value given in the recommended capacitor specifications table ( $0.47/1.5\mu\text{F}$  in this case). Note that the graph shows the capacitance out of spec for the 0402 case size capacitor at higher bias voltages. It is therefore recommended that the capacitor manufacturers' specifications for the nominal value capacitor are consulted for all conditions, as some capacitor sizes (e.g. 0402) may not be suitable in the actual application.

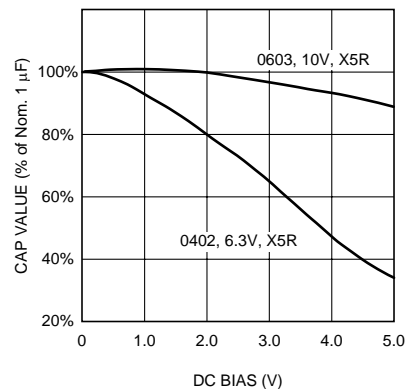

**Figure 20. Graph Showing A Typical Variation In Capacitance vs DC Bias**

The ceramic capacitor's capacitance can vary with temperature. The capacitor type X7R, which operates over a temperature range of  $-55^{\circ}\text{C}$  to  $+125^{\circ}\text{C}$ , will only vary the capacitance to within  $\pm 15\%$ . The capacitor type X5R has a similar tolerance over a reduced temperature range of  $-55^{\circ}\text{C}$  to  $+85^{\circ}\text{C}$ . Many large value ceramic capacitors, larger than  $1\mu\text{F}$  are manufactured with Z5U or Y5V temperature characteristics. Their capacitance can drop by more than 50% as the temperature varies from  $25^{\circ}\text{C}$  to  $85^{\circ}\text{C}$ . Therefore X7R is recommended over Z5U and Y5V in applications where the ambient temperature will change significantly above or below  $25^{\circ}\text{C}$ .

Tantalum capacitors are less desirable than ceramic for use as output capacitors because they are more expensive when comparing equivalent capacitance and voltage ratings in the  $1\mu\text{F}$  to  $4.7\mu\text{F}$  range.

Another important consideration is that tantalum capacitors have higher ESR values than equivalent size ceramics. This means that while it may be possible to find a tantalum capacitor with an ESR value within the stable range, it would have to be larger in capacitance (which means bigger and more costly) than a ceramic capacitor with the same ESR value. It should also be noted that the ESR of a typical tantalum will increase about 2:1 as the temperature goes from  $25^{\circ}\text{C}$  down to  $-40^{\circ}\text{C}$ , so some guard band must be allowed.

## NO-LOAD STABILITY

The LP5952 will remain stable and in regulation with no external load. This is an important consideration in some circuits, for example CMOS RAM keep-alive applications.

## ENABLE OPERATION

The LP5952 may be switched ON or OFF by a logic input at the Enable pin,  $V_{EN}$ . A logic high at this pin will turn the device on. When the enable pin is low, the regulator output is off and the device typically consumes 0.1  $\mu$ A.

If the application does not require the Enable switching feature, the  $V_{EN}$  pin should be tied to  $V_{BATT}$  to keep the regulator output permanently on.

To ensure proper operation, the signal source used to drive the  $V_{EN}$  input must be able to swing above and below the specified turn-on/off voltage thresholds listed in the Electrical Characteristics section under Enable Control Characteristics,  $V_{IL}$  and  $V_{IH}$ .

## FAST TURN ON

Fast turn-on is ensured by an optimized architecture allowing a fast ramp of the output voltage to reach the target voltage while the inrush current is controlled low at 120mA typical (for a  $C_{OUT}$  of 2.2 $\mu$ F).

## SHORT-CIRCUIT PROTECTION

The LP5952 is short circuit protected and in the event of a peak over-current condition, the output current through the NFET pass device will be limited.

If the over-current condition exists for a longer time, the average power dissipation will increase depending on the input to output voltage difference until the thermal shutdown circuitry will turn off the NFET.

Please refer to the section on thermal information for power dissipation calculations.

## THERMAL-OVERLOAD PROTECTION

Thermal-Overload Protection limits the total power dissipation in the LP5952. When the junction temperature exceeds  $T_J = 165^\circ\text{C}$  typ., the shutdown logic is triggered and the NFET is turned off, allowing the device to cool down. After the junction temperature dropped by  $20^\circ\text{C}$  (temperature hysteresis) typical, the NFET is activated again. This results in a pulsed output voltage during continuous thermal-overload conditions.

The Thermal-Overload Protection is designed to protect the LP5952 in the event of a fault condition. For normal, continuous operation, do not exceed the absolute maximum junction temperature rating of  $T_J = +150^\circ\text{C}$  (see Absolute Maximum Ratings).

## REVERSE CURRENT PATH

The internal NFET pass device in LP5952 has an inherent parasitic body diode. During normal operation, the input voltage is higher than the output voltage and the parasitic diode is reverse biased. However, if the output is pulled above the input in an application, then current flows from the output to the input as the parasitic diode gets forward biased. The output can be pulled above the input as long as the current in the parasitic diode is limited to 50mA. For currents above this limit an external Schottky diode must be connected from  $V_{OUT}$  to  $V_{IN}$  (cathode on  $V_{IN}$ , anode on  $V_{OUT}$ ).

## EVALUATION BOARDS

For availability of evaluation boards please refer to the Product Folder of LP5952 at [www.ti.com](http://www.ti.com).

For information regarding evaluation boards, please refer to Application Note: AN-1531 [SNVA188](#).

---

**REVISION HISTORY**

| <b>Changes from Revision D (April 2013) to Revision E</b>  | <b>Page</b>     |
|--|-----------------|
| <hr/> <ul style="list-style-type: none"><li>• Changed layout of National Data Sheet to TI format .....</li></ul> | <hr/> <b>14</b> |

**PACKAGING INFORMATION**

| Orderable Device   | Status<br>(1) | Package Type | Package Drawing | Pins | Package Qty | Eco Plan<br>(2)         | Lead/Ball Finish | MSL Peak Temp<br>(3) | Op Temp (°C) | Top-Side Markings<br>(4) | Samples                 |
|--------------------|---------------|--------------|-----------------|------|-------------|-------------------------|------------------|----------------------|--------------|--------------------------|-------------------------|
| LP5952LC-1.2/NOPB  | ACTIVE        | USON         | NKH             | 6    | 1000        | Green (RoHS & no Sb/Br) | CU NIPDAU        | Level-1-260C-UNLIM   | -40 to 125   | L28                      | <a href="#">Samples</a> |
| LP5952LC-1.3/NOPB  | ACTIVE        | USON         | NKH             | 6    | 1000        | Green (RoHS & no Sb/Br) | CU NIPDAU        | Level-1-260C-UNLIM   | -40 to 125   | L43                      | <a href="#">Samples</a> |
| LP5952LC-1.5/NOPB  | ACTIVE        | USON         | NKH             | 6    | 1000        | Green (RoHS & no Sb/Br) | CU NIPDAU        | Level-1-260C-UNLIM   | -40 to 125   | L25                      | <a href="#">Samples</a> |
| LP5952LC-1.8/NOPB  | ACTIVE        | USON         | NKH             | 6    | 1000        | Green (RoHS & no Sb/Br) | CU NIPDAU        | Level-1-260C-UNLIM   | -40 to 125   | L29                      | <a href="#">Samples</a> |
| LP5952LCX-1.2/NOPB | ACTIVE        | USON         | NKH             | 6    | 4500        | Green (RoHS & no Sb/Br) | CU NIPDAU        | Level-1-260C-UNLIM   | -40 to 125   | L28                      | <a href="#">Samples</a> |
| LP5952LCX-1.3/NOPB | ACTIVE        | USON         | NKH             | 6    | 4500        | Green (RoHS & no Sb/Br) | CU NIPDAU        | Level-1-260C-UNLIM   | -40 to 125   | L43                      | <a href="#">Samples</a> |
| LP5952LCX-1.5/NOPB | ACTIVE        | USON         | NKH             | 6    | 4500        | Green (RoHS & no Sb/Br) | CU NIPDAU        | Level-1-260C-UNLIM   | -40 to 125   | L25                      | <a href="#">Samples</a> |
| LP5952LCX-1.8/NOPB | ACTIVE        | USON         | NKH             | 6    | 4500        | Green (RoHS & no Sb/Br) | CU NIPDAU        | Level-1-260C-UNLIM   | -40 to 125   | L29                      | <a href="#">Samples</a> |
| LP5952TL-0.7/NOPB  | ACTIVE        | DSBGA        | YZR             | 5    | 250         | Green (RoHS & no Sb/Br) | SNAGCU           | Level-1-260C-UNLIM   | -40 to 125   | 4                        | <a href="#">Samples</a> |
| LP5952TL-1.0/NOPB  | ACTIVE        | DSBGA        | YZR             | 5    | 250         | Green (RoHS & no Sb/Br) | SNAGCU           | Level-1-260C-UNLIM   | -40 to 125   | L                        | <a href="#">Samples</a> |
| LP5952TL-1.2/NOPB  | ACTIVE        | DSBGA        | YZR             | 5    | 250         | Green (RoHS & no Sb/Br) | SNAGCU           | Level-1-260C-UNLIM   | -40 to 125   | 7                        | <a href="#">Samples</a> |
| LP5952TL-1.3/NOPB  | ACTIVE        | DSBGA        | YZR             | 5    | 250         | Green (RoHS & no Sb/Br) | SNAGCU           | Level-1-260C-UNLIM   | -40 to 125   | U                        | <a href="#">Samples</a> |
| LP5952TL-1.4/NOPB  | ACTIVE        | DSBGA        | YZR             | 5    | 250         | Green (RoHS & no Sb/Br) | SNAGCU           | Level-1-260C-UNLIM   | -40 to 125   | A                        | <a href="#">Samples</a> |
| LP5952TL-1.5/NOPB  | ACTIVE        | DSBGA        | YZR             | 5    | 250         | Green (RoHS & no Sb/Br) | SNAGCU           | Level-1-260C-UNLIM   | -40 to 125   | T                        | <a href="#">Samples</a> |
| LP5952TL-1.6/NOPB  | ACTIVE        | DSBGA        | YZR             | 5    | 250         | Green (RoHS & no Sb/Br) | SNAGCU           | Level-1-260C-UNLIM   | -40 to 125   | B                        | <a href="#">Samples</a> |
| LP5952TL-1.8/NOPB  | ACTIVE        | DSBGA        | YZR             | 5    | 250         | Green (RoHS & no Sb/Br) | SNAGCU           | Level-1-260C-UNLIM   | -40 to 125   | 8                        | <a href="#">Samples</a> |
| LP5952TL-2.0/NOPB  | ACTIVE        | DSBGA        | YZR             | 5    | 250         | Green (RoHS & no Sb/Br) | SNAGCU           | Level-1-260C-UNLIM   | -40 to 125   | 5                        | <a href="#">Samples</a> |



| Orderable Device   | Status<br>(1) | Package Type | Package Drawing | Pins | Package Qty | Eco Plan<br>(2)         | Lead/Ball Finish | MSL Peak Temp<br>(3) | Op Temp (°C) | Top-Side Markings<br>(4) | Samples                 |
|--------------------|---------------|--------------|-----------------|------|-------------|-------------------------|------------------|----------------------|--------------|--------------------------|-------------------------|
| LP5952TLX-0.7/NOPB | ACTIVE        | DSBGA        | YZR             | 5    | 3000        | Green (RoHS & no Sb/Br) | SNAGCU           | Level-1-260C-UNLIM   | -40 to 125   | 4                        | <a href="#">Samples</a> |
| LP5952TLX-1.0/NOPB | ACTIVE        | DSBGA        | YZR             | 5    | 3000        | Green (RoHS & no Sb/Br) | SNAGCU           | Level-1-260C-UNLIM   | -40 to 125   | L                        | <a href="#">Samples</a> |
| LP5952TLX-1.2/NOPB | ACTIVE        | DSBGA        | YZR             | 5    | 3000        | Green (RoHS & no Sb/Br) | SNAGCU           | Level-1-260C-UNLIM   | -40 to 125   | 7                        | <a href="#">Samples</a> |
| LP5952TLX-1.3/NOPB | ACTIVE        | DSBGA        | YZR             | 5    | 3000        | Green (RoHS & no Sb/Br) | SNAGCU           | Level-1-260C-UNLIM   | -40 to 125   | U                        | <a href="#">Samples</a> |
| LP5952TLX-1.4/NOPB | ACTIVE        | DSBGA        | YZR             | 5    | 3000        | Green (RoHS & no Sb/Br) | SNAGCU           | Level-1-260C-UNLIM   | -40 to 125   | A                        | <a href="#">Samples</a> |
| LP5952TLX-1.5/NOPB | ACTIVE        | DSBGA        | YZR             | 5    | 3000        | Green (RoHS & no Sb/Br) | SNAGCU           | Level-1-260C-UNLIM   | -40 to 125   | T                        | <a href="#">Samples</a> |
| LP5952TLX-1.6/NOPB | ACTIVE        | DSBGA        | YZR             | 5    | 3000        | Green (RoHS & no Sb/Br) | SNAGCU           | Level-1-260C-UNLIM   | -40 to 125   | B                        | <a href="#">Samples</a> |
| LP5952TLX-1.8/NOPB | ACTIVE        | DSBGA        | YZR             | 5    | 3000        | Green (RoHS & no Sb/Br) | SNAGCU           | Level-1-260C-UNLIM   | -40 to 125   | 8                        | <a href="#">Samples</a> |
| LP5952TLX-2.0/NOPB | ACTIVE        | DSBGA        | YZR             | 5    | 3000        | Green (RoHS & no Sb/Br) | SNAGCU           | Level-1-260C-UNLIM   | -40 to 125   | 5                        | <a href="#">Samples</a> |

(1) The marketing status values are defined as follows:

**ACTIVE:** Product device recommended for new designs.

**LIFEBUY:** TI has announced that the device will be discontinued, and a lifetime-buy period is in effect.

**NRND:** Not recommended for new designs. Device is in production to support existing customers, but TI does not recommend using this part in a new design.

**PREVIEW:** Device has been announced but is not in production. Samples may or may not be available.

**OBSELETE:** TI has discontinued the production of the device.

(2) Eco Plan - The planned eco-friendly classification: Pb-Free (RoHS), Pb-Free (RoHS Exempt), or Green (RoHS & no Sb/Br) - please check <http://www.ti.com/productcontent> for the latest availability information and additional product content details.

**TBD:** The Pb-Free/Green conversion plan has not been defined.

**Pb-Free (RoHS):** TI's terms "Lead-Free" or "Pb-Free" mean semiconductor products that are compatible with the current RoHS requirements for all 6 substances, including the requirement that lead not exceed 0.1% by weight in homogeneous materials. Where designed to be soldered at high temperatures, TI Pb-Free products are suitable for use in specified lead-free processes.

**Pb-Free (RoHS Exempt):** This component has a RoHS exemption for either 1) lead-based flip-chip solder bumps used between the die and package, or 2) lead-based die adhesive used between the die and leadframe. The component is otherwise considered Pb-Free (RoHS compatible) as defined above.

**Green (RoHS & no Sb/Br):** TI defines "Green" to mean Pb-Free (RoHS compatible), and free of Bromine (Br) and Antimony (Sb) based flame retardants (Br or Sb do not exceed 0.1% by weight in homogeneous material)

(3) MSL, Peak Temp. -- The Moisture Sensitivity Level rating according to the JEDEC industry standard classifications, and peak solder temperature.

<sup>(4)</sup> Multiple Top-Side Markings will be inside parentheses. Only one Top-Side Marking contained in parentheses and separated by a "~" will appear on a device. If a line is indented then it is a continuation of the previous line and the two combined represent the entire Top-Side Marking for that device.

**Important Information and Disclaimer:** The information provided on this page represents TI's knowledge and belief as of the date that it is provided. TI bases its knowledge and belief on information provided by third parties, and makes no representation or warranty as to the accuracy of such information. Efforts are underway to better integrate information from third parties. TI has taken and continues to take reasonable steps to provide representative and accurate information but may not have conducted destructive testing or chemical analysis on incoming materials and chemicals. TI and TI suppliers consider certain information to be proprietary, and thus CAS numbers and other limited information may not be available for release.

In no event shall TI's liability arising out of such information exceed the total purchase price of the TI part(s) at issue in this document sold by TI to Customer on an annual basis.

**TAPE AND REEL INFORMATION**

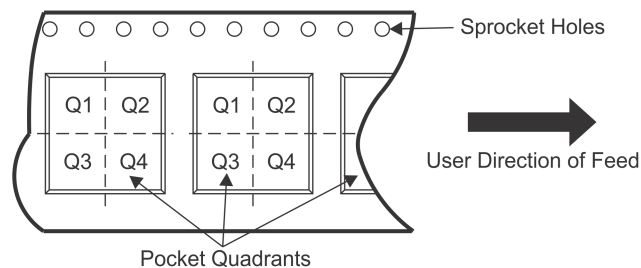
**QUADRANT ASSIGNMENTS FOR PIN 1 ORIENTATION IN TAPE**

\*All dimensions are nominal

| Device             | Package Type | Package Drawing | Pins | SPQ  | Reel Diameter (mm) | Reel Width W1 (mm) | A0 (mm) | B0 (mm) | K0 (mm) | P1 (mm) | W (mm) | Pin1 Quadrant |
|--------------------|--------------|-----------------|------|------|--------------------|--------------------|---------|---------|---------|---------|--------|---------------|
| LP5952LC-1.2/NOPB  | USON         | NKH             | 6    | 1000 | 178.0              | 12.4               | 2.2     | 2.2     | 1.0     | 8.0     | 12.0   | Q1            |
| LP5952LC-1.3/NOPB  | USON         | NKH             | 6    | 1000 | 178.0              | 12.4               | 2.2     | 2.2     | 1.0     | 8.0     | 12.0   | Q1            |
| LP5952LC-1.5/NOPB  | USON         | NKH             | 6    | 1000 | 178.0              | 12.4               | 2.2     | 2.2     | 1.0     | 8.0     | 12.0   | Q1            |
| LP5952LC-1.8/NOPB  | USON         | NKH             | 6    | 1000 | 178.0              | 12.4               | 2.2     | 2.2     | 1.0     | 8.0     | 12.0   | Q1            |
| LP5952LCX-1.2/NOPB | USON         | NKH             | 6    | 4500 | 330.0              | 12.4               | 2.2     | 2.2     | 1.0     | 8.0     | 12.0   | Q1            |
| LP5952LCX-1.3/NOPB | USON         | NKH             | 6    | 4500 | 330.0              | 12.4               | 2.2     | 2.2     | 1.0     | 8.0     | 12.0   | Q1            |
| LP5952LCX-1.5/NOPB | USON         | NKH             | 6    | 4500 | 330.0              | 12.4               | 2.2     | 2.2     | 1.0     | 8.0     | 12.0   | Q1            |
| LP5952LCX-1.8/NOPB | USON         | NKH             | 6    | 4500 | 330.0              | 12.4               | 2.2     | 2.2     | 1.0     | 8.0     | 12.0   | Q1            |
| LP5952TL-0.7/NOPB  | DSBGA        | YZR             | 5    | 250  | 178.0              | 8.4                | 1.04    | 1.4     | 0.76    | 4.0     | 8.0    | Q1            |
| LP5952TL-1.0/NOPB  | DSBGA        | YZR             | 5    | 250  | 178.0              | 8.4                | 1.04    | 1.4     | 0.76    | 4.0     | 8.0    | Q1            |
| LP5952TL-1.2/NOPB  | DSBGA        | YZR             | 5    | 250  | 178.0              | 8.4                | 1.04    | 1.4     | 0.76    | 4.0     | 8.0    | Q1            |
| LP5952TL-1.3/NOPB  | DSBGA        | YZR             | 5    | 250  | 178.0              | 8.4                | 1.04    | 1.4     | 0.76    | 4.0     | 8.0    | Q1            |
| LP5952TL-1.4/NOPB  | DSBGA        | YZR             | 5    | 250  | 178.0              | 8.4                | 1.04    | 1.4     | 0.76    | 4.0     | 8.0    | Q1            |
| LP5952TL-1.5/NOPB  | DSBGA        | YZR             | 5    | 250  | 178.0              | 8.4                | 1.04    | 1.4     | 0.76    | 4.0     | 8.0    | Q1            |
| LP5952TL-1.6/NOPB  | DSBGA        | YZR             | 5    | 250  | 178.0              | 8.4                | 1.04    | 1.4     | 0.76    | 4.0     | 8.0    | Q1            |
| LP5952TL-1.8/NOPB  | DSBGA        | YZR             | 5    | 250  | 178.0              | 8.4                | 1.04    | 1.4     | 0.76    | 4.0     | 8.0    | Q1            |
| LP5952TL-2.0/NOPB  | DSBGA        | YZR             | 5    | 250  | 178.0              | 8.4                | 1.04    | 1.4     | 0.76    | 4.0     | 8.0    | Q1            |
| LP5952TLX-0.7/NOPB | DSBGA        | YZR             | 5    | 3000 | 178.0              | 8.4                | 1.04    | 1.4     | 0.76    | 4.0     | 8.0    | Q1            |

| Device             | Package Type | Package Drawing | Pins | SPQ  | Reel Diameter (mm) | Reel Width W1 (mm) | A0 (mm) | B0 (mm) | K0 (mm) | P1 (mm) | W (mm) | Pin1 Quadrant |
|--------------------|--------------|-----------------|------|------|--------------------|--------------------|---------|---------|---------|---------|--------|---------------|
| LP5952TLX-1.0/NOPB | DSBGA        | YZR             | 5    | 3000 | 178.0              | 8.4                | 1.04    | 1.4     | 0.76    | 4.0     | 8.0    | Q1            |
| LP5952TLX-1.2/NOPB | DSBGA        | YZR             | 5    | 3000 | 178.0              | 8.4                | 1.04    | 1.4     | 0.76    | 4.0     | 8.0    | Q1            |
| LP5952TLX-1.3/NOPB | DSBGA        | YZR             | 5    | 3000 | 178.0              | 8.4                | 1.04    | 1.4     | 0.76    | 4.0     | 8.0    | Q1            |
| LP5952TLX-1.4/NOPB | DSBGA        | YZR             | 5    | 3000 | 178.0              | 8.4                | 1.04    | 1.4     | 0.76    | 4.0     | 8.0    | Q1            |
| LP5952TLX-1.5/NOPB | DSBGA        | YZR             | 5    | 3000 | 178.0              | 8.4                | 1.04    | 1.4     | 0.76    | 4.0     | 8.0    | Q1            |
| LP5952TLX-1.6/NOPB | DSBGA        | YZR             | 5    | 3000 | 178.0              | 8.4                | 1.04    | 1.4     | 0.76    | 4.0     | 8.0    | Q1            |
| LP5952TLX-1.8/NOPB | DSBGA        | YZR             | 5    | 3000 | 178.0              | 8.4                | 1.04    | 1.4     | 0.76    | 4.0     | 8.0    | Q1            |
| LP5952TLX-2.0/NOPB | DSBGA        | YZR             | 5    | 3000 | 178.0              | 8.4                | 1.04    | 1.4     | 0.76    | 4.0     | 8.0    | Q1            |

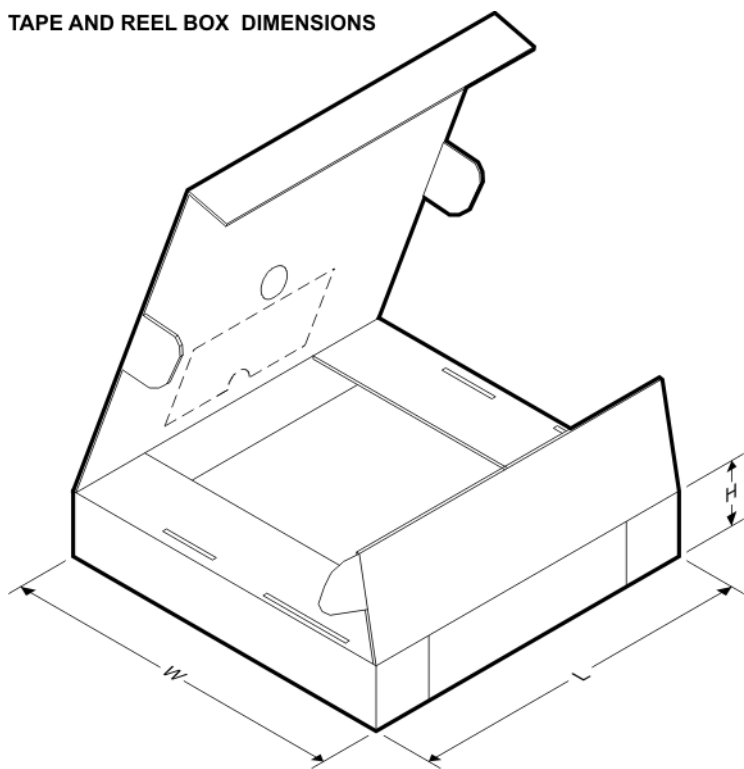
**TAPE AND REEL BOX DIMENSIONS**

\*All dimensions are nominal

| Device             | Package Type | Package Drawing | Pins | SPQ  | Length (mm) | Width (mm) | Height (mm) |
|--------------------|--------------|-----------------|------|------|-------------|------------|-------------|
| LP5952LC-1.2/NOPB  | USON         | NKH             | 6    | 1000 | 210.0       | 185.0      | 35.0        |
| LP5952LC-1.3/NOPB  | USON         | NKH             | 6    | 1000 | 210.0       | 185.0      | 35.0        |
| LP5952LC-1.5/NOPB  | USON         | NKH             | 6    | 1000 | 210.0       | 185.0      | 35.0        |
| LP5952LC-1.8/NOPB  | USON         | NKH             | 6    | 1000 | 210.0       | 185.0      | 35.0        |
| LP5952LCX-1.2/NOPB | USON         | NKH             | 6    | 4500 | 367.0       | 367.0      | 35.0        |
| LP5952LCX-1.3/NOPB | USON         | NKH             | 6    | 4500 | 367.0       | 367.0      | 35.0        |
| LP5952LCX-1.5/NOPB | USON         | NKH             | 6    | 4500 | 367.0       | 367.0      | 35.0        |
| LP5952LCX-1.8/NOPB | USON         | NKH             | 6    | 4500 | 367.0       | 367.0      | 35.0        |
| LP5952TL-0.7/NOPB  | DSBGA        | YZR             | 5    | 250  | 210.0       | 185.0      | 35.0        |

| Device             | Package Type | Package Drawing | Pins | SPQ  | Length (mm) | Width (mm) | Height (mm) |
|--------------------|--------------|-----------------|------|------|-------------|------------|-------------|
| LP5952TL-1.0/NOPB  | DSBGA        | YZR             | 5    | 250  | 210.0       | 185.0      | 35.0        |
| LP5952TL-1.2/NOPB  | DSBGA        | YZR             | 5    | 250  | 210.0       | 185.0      | 35.0        |
| LP5952TL-1.3/NOPB  | DSBGA        | YZR             | 5    | 250  | 210.0       | 185.0      | 35.0        |
| LP5952TL-1.4/NOPB  | DSBGA        | YZR             | 5    | 250  | 210.0       | 185.0      | 35.0        |
| LP5952TL-1.5/NOPB  | DSBGA        | YZR             | 5    | 250  | 210.0       | 185.0      | 35.0        |
| LP5952TL-1.6/NOPB  | DSBGA        | YZR             | 5    | 250  | 210.0       | 185.0      | 35.0        |
| LP5952TL-1.8/NOPB  | DSBGA        | YZR             | 5    | 250  | 210.0       | 185.0      | 35.0        |
| LP5952TL-2.0/NOPB  | DSBGA        | YZR             | 5    | 250  | 210.0       | 185.0      | 35.0        |
| LP5952TLX-0.7/NOPB | DSBGA        | YZR             | 5    | 3000 | 210.0       | 185.0      | 35.0        |
| LP5952TLX-1.0/NOPB | DSBGA        | YZR             | 5    | 3000 | 210.0       | 185.0      | 35.0        |
| LP5952TLX-1.2/NOPB | DSBGA        | YZR             | 5    | 3000 | 210.0       | 185.0      | 35.0        |
| LP5952TLX-1.3/NOPB | DSBGA        | YZR             | 5    | 3000 | 210.0       | 185.0      | 35.0        |
| LP5952TLX-1.4/NOPB | DSBGA        | YZR             | 5    | 3000 | 210.0       | 185.0      | 35.0        |
| LP5952TLX-1.5/NOPB | DSBGA        | YZR             | 5    | 3000 | 210.0       | 185.0      | 35.0        |
| LP5952TLX-1.6/NOPB | DSBGA        | YZR             | 5    | 3000 | 210.0       | 185.0      | 35.0        |
| LP5952TLX-1.8/NOPB | DSBGA        | YZR             | 5    | 3000 | 210.0       | 185.0      | 35.0        |
| LP5952TLX-2.0/NOPB | DSBGA        | YZR             | 5    | 3000 | 210.0       | 185.0      | 35.0        |

NKH0006B

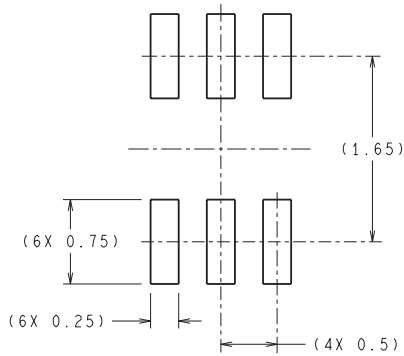

RECOMMENDED LAND PATTERN

DIMENSIONS ARE IN MILLIMETERS  
DIMENSION IN ( ) FOR REFERENCE ONLY

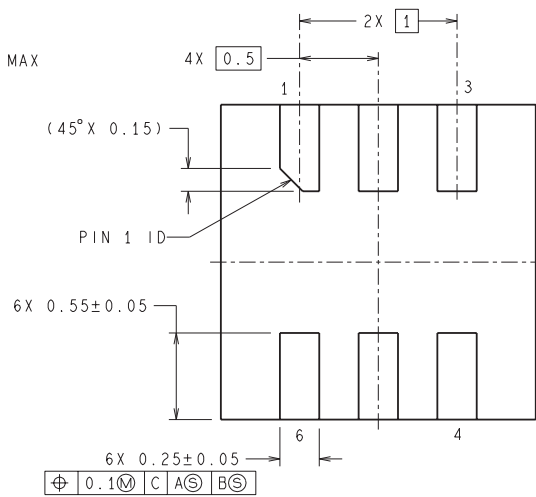
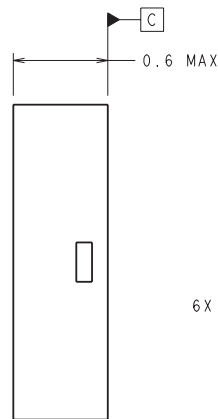
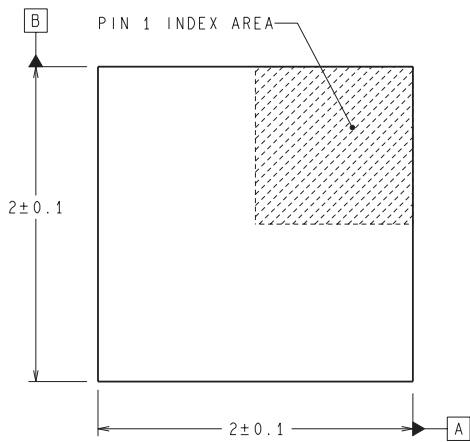
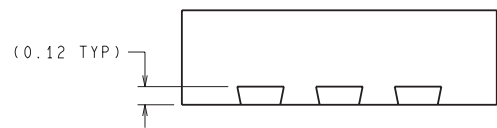

LCA06B (Rev A)

YZR0005

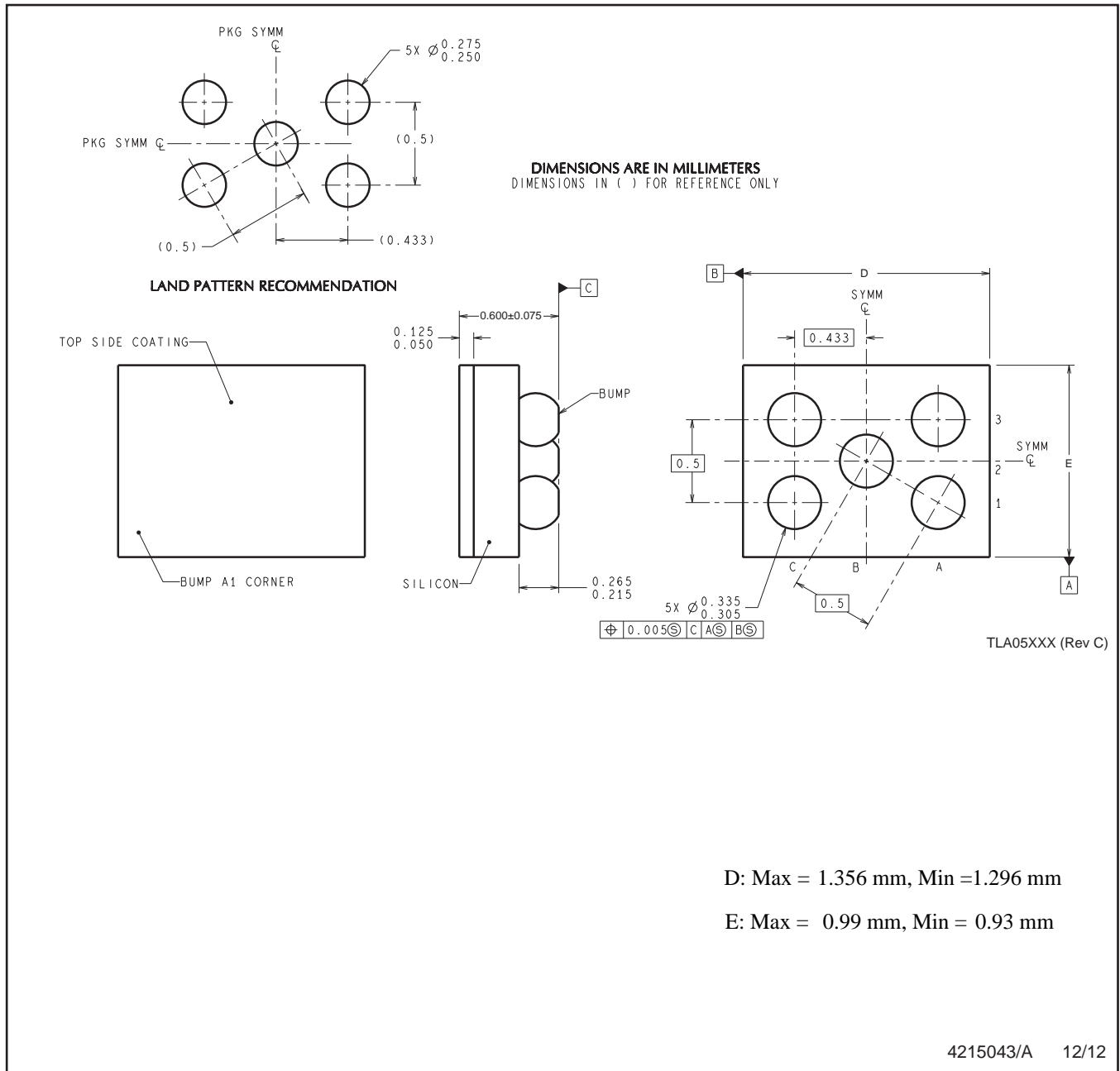

D: Max = 1.356 mm, Min = 1.296 mm

E: Max = 0.99 mm, Min = 0.93 mm

4215043/A 12/12

NOTES: A. All linear dimensions are in millimeters. Dimensioning and tolerancing per ASME Y14.5M-1994.  
 B. This drawing is subject to change without notice.

## IMPORTANT NOTICE

Texas Instruments Incorporated and its subsidiaries (TI) reserve the right to make corrections, enhancements, improvements and other changes to its semiconductor products and services per JESD46, latest issue, and to discontinue any product or service per JESD48, latest issue. Buyers should obtain the latest relevant information before placing orders and should verify that such information is current and complete. All semiconductor products (also referred to herein as "components") are sold subject to TI's terms and conditions of sale supplied at the time of order acknowledgment.

TI warrants performance of its components to the specifications applicable at the time of sale, in accordance with the warranty in TI's terms and conditions of sale of semiconductor products. Testing and other quality control techniques are used to the extent TI deems necessary to support this warranty. Except where mandated by applicable law, testing of all parameters of each component is not necessarily performed.

TI assumes no liability for applications assistance or the design of Buyers' products. Buyers are responsible for their products and applications using TI components. To minimize the risks associated with Buyers' products and applications, Buyers should provide adequate design and operating safeguards.

TI does not warrant or represent that any license, either express or implied, is granted under any patent right, copyright, mask work right, or other intellectual property right relating to any combination, machine, or process in which TI components or services are used. Information published by TI regarding third-party products or services does not constitute a license to use such products or services or a warranty or endorsement thereof. Use of such information may require a license from a third party under the patents or other intellectual property of the third party, or a license from TI under the patents or other intellectual property of TI.

Reproduction of significant portions of TI information in TI data books or data sheets is permissible only if reproduction is without alteration and is accompanied by all associated warranties, conditions, limitations, and notices. TI is not responsible or liable for such altered documentation. Information of third parties may be subject to additional restrictions.

Resale of TI components or services with statements different from or beyond the parameters stated by TI for that component or service voids all express and any implied warranties for the associated TI component or service and is an unfair and deceptive business practice. TI is not responsible or liable for any such statements.

Buyer acknowledges and agrees that it is solely responsible for compliance with all legal, regulatory and safety-related requirements concerning its products, and any use of TI components in its applications, notwithstanding any applications-related information or support that may be provided by TI. Buyer represents and agrees that it has all the necessary expertise to create and implement safeguards which anticipate dangerous consequences of failures, monitor failures and their consequences, lessen the likelihood of failures that might cause harm and take appropriate remedial actions. Buyer will fully indemnify TI and its representatives against any damages arising out of the use of any TI components in safety-critical applications.

In some cases, TI components may be promoted specifically to facilitate safety-related applications. With such components, TI's goal is to help enable customers to design and create their own end-product solutions that meet applicable functional safety standards and requirements. Nonetheless, such components are subject to these terms.

No TI components are authorized for use in FDA Class III (or similar life-critical medical equipment) unless authorized officers of the parties have executed a special agreement specifically governing such use.

Only those TI components which TI has specifically designated as military grade or "enhanced plastic" are designed and intended for use in military/aerospace applications or environments. Buyer acknowledges and agrees that any military or aerospace use of TI components which have **not** been so designated is solely at the Buyer's risk, and that Buyer is solely responsible for compliance with all legal and regulatory requirements in connection with such use.

TI has specifically designated certain components as meeting ISO/TS16949 requirements, mainly for automotive use. In any case of use of non-designated products, TI will not be responsible for any failure to meet ISO/TS16949.

### Products

|                              |  |
|------------------------------|--|
| Audio                        | <a href="http://www.ti.com/audio">www.ti.com/audio</a>                               |
| Amplifiers                   | <a href="http://amplifier.ti.com">amplifier.ti.com</a>                               |
| Data Converters              | <a href="http://dataconverter.ti.com">dataconverter.ti.com</a>                       |
| DLP® Products                | <a href="http://www.dlp.com">www.dlp.com</a>   |
| DSP                          | <a href="http://dsp.ti.com">dsp.ti.com</a>   |
| Clocks and Timers            | <a href="http://www.ti.com/clocks">www.ti.com/clocks</a>                             |
| Interface                    | <a href="http://interface.ti.com">interface.ti.com</a>                               |
| Logic                        | <a href="http://logic.ti.com">logic.ti.com</a>                                       |
| Power Mgmt                   | <a href="http://power.ti.com">power.ti.com</a>                                       |
| Microcontrollers             | <a href="http://microcontroller.ti.com">microcontroller.ti.com</a>                   |
| RFID                         | <a href="http://www.ti-rfid.com">www.ti-rfid.com</a>                                 |
| OMAP Applications Processors | <a href="http://www.ti.com/omap">www.ti.com/omap</a>                                 |
| Wireless Connectivity        | <a href="http://www.ti.com/wirelessconnectivity">www.ti.com/wirelessconnectivity</a> |

### Applications

|                               |  |
|-------------------------------|--|
| Automotive and Transportation | <a href="http://www.ti.com/automotive">www.ti.com/automotive</a>                         |
| Communications and Telecom    | <a href="http://www.ti.com/communications">www.ti.com/communications</a>                 |
| Computers and Peripherals     | <a href="http://www.ti.com/computers">www.ti.com/computers</a>                           |
| Consumer Electronics          | <a href="http://www.ti.com/consumer-apps">www.ti.com/consumer-apps</a>                   |
| Energy and Lighting           | <a href="http://www.ti.com/energy">www.ti.com/energy</a>                                 |
| Industrial                    | <a href="http://www.ti.com/industrial">www.ti.com/industrial</a>                         |
| Medical                       | <a href="http://www.ti.com/medical">www.ti.com/medical</a>                               |
| Security                      | <a href="http://www.ti.com/security">www.ti.com/security</a>                             |
| Space, Avionics and Defense   | <a href="http://www.ti.com/space-avionics-defense">www.ti.com/space-avionics-defense</a> |
| Video and Imaging             | <a href="http://www.ti.com/video">www.ti.com/video</a>                                   |

### TI E2E Community

[e2e.ti.com](http://e2e.ti.com)