

$V_{DSS}$	20V
$R_{DS(on)}$ (Max.)	3.5Ω
$I_D$	100mA
$P_D$	150mW

#### ●Features

- 1) Low voltage drive(1.2V) makes this device ideal for portable equipment.
- 2) Drive circuits can be simple.
- 3) Built-in G-S Protection Diode.

#### ●Application

Switching

#### ●Outline

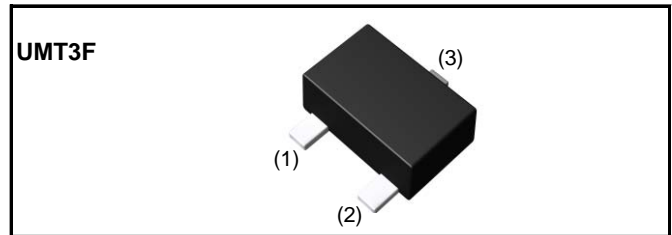

#### ●Inner circuit

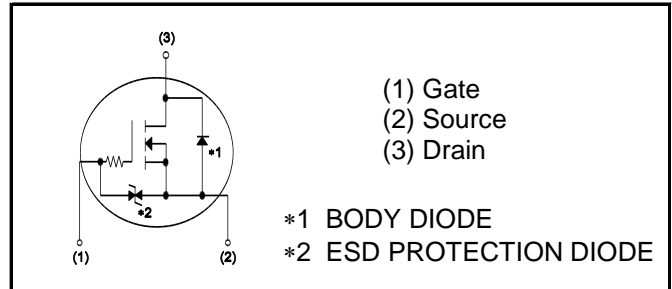

#### ●Packaging specifications

Type	Packaging	Taping
	Reel size (mm)	180
	Tape width (mm)	8
	Basic ordering unit (pcs)	3,000
	Taping code	TL
	Marking	RW

#### ●Absolute maximum ratings( $T_a = 25^\circ\text{C}$ )

Parameter	Symbol	Value	Unit
Drain - Source voltage	$V_{DSS}$	20	V
Continuous drain current	$I_D^{*1}$	±100	mA
Pulsed drain current	$I_{D,pulse}^{*2}$	±400	mA
Gate - Source voltage	$V_{GSS}$	±8	V
Power dissipation	$P_D^{*3}$	150	mW
Junction temperature	$T_j$	150	°C
Range of storage temperature	$T_{stg}$	-55 to +150	°C

#### ●Thermal resistance

Parameter	Symbol	Values			Unit
		Min.	Typ.	Max.	
Thermal resistance, junction - ambient	$R_{thJA}^{*3}$	-	-	833	°C/W

●Electrical characteristics( $T_a = 25^\circ\text{C}$ )

Parameter	Symbol	Conditions	Values			Unit
			Min.	Typ.	Max.	
Drain - Source breakdown voltage	$V_{(BR)DSS}$	$V_{GS} = 0V, I_D = 1mA$	20	-	-	V
Zero gate voltage drain current	$I_{DSS}$	$V_{DS} = 20V, V_{GS} = 0V$	-	-	1	$\mu A$
Gate - Source leakage current	$I_{GSS}$	$V_{GS} = \pm 8V, V_{DS} = 0V$	-	-	$\pm 10$	$\mu A$
Gate threshold voltage	$V_{GS(th)}$	$V_{DS} = 10V, I_D = 100\mu A$	0.3	-	1.0	V
Static drain - source on - state resistance	$R_{DS(on)}$ *4	$V_{GS}=4.5V, I_D=100mA$	-	2.5	3.5	$\Omega$
		$V_{GS}=2.5V, I_D=100mA$	-	3.0	4.2	
		$V_{GS}=1.8V, I_D=50mA$	-	3.8	5.3	
		$V_{GS}=1.5V, I_D=20mA$	-	4.5	9.0	
		$V_{GS}=1.2V, I_D=10mA$	-	6.0	18.0	
		$V_{GS}=4.5V, I_D=100mA, T_j=125^\circ C$	-	4.0	5.6	
Transconductance	$g_{fs}$ *4	$V_{DS}=10V, I_D=100mA$	180	-	-	mS

\*1 Limited only by maximum temperature allowed.

\*2  $P_w \leq 10\mu s$ , Duty cycle  $\leq 1\%$

\*3 Each terminal mounted on a recommended land

\*4 Pulsed

●Electrical characteristics( $T_a = 25^\circ\text{C}$ )

Parameter	Symbol	Conditions	Values			Unit
			Min.	Typ.	Max.	
Input capacitance	$C_{iss}$	$V_{GS} = 0V$	-	7.1	-	pF
Output capacitance	$C_{oss}$	$V_{DS} = 10V$	-	3.3	-	
Reverse transfer capacitance	$C_{rss}$	$f = 1MHz$	-	1.7	-	
Turn - on delay time	$t_{d(on)}^{*4}$	$V_{DD} \approx 10V, V_{GS} = 4.5V$	-	5	-	ns
Rise time	$t_r^{*4}$	$I_D = 50mA$	-	4	-	
Turn - off delay time	$t_{d(off)}^{*4}$	$R_L = 200\Omega$	-	20	-	
Fall time	$t_f^{*4}$	$R_G = 10\Omega$	-	38	-	

●Body diode electrical characteristics (Source-Drain)( $T_a = 25^\circ\text{C}$ )

Parameter	Symbol	Conditions	Values			Unit
			Min.	Typ.	Max.	
Continuous source current	$I_s^{*1}$	$T_c = 25^\circ\text{C}$	-	-	100	mA
Pulsed source current	$I_{SM}^{*2}$		-	-	400	mA
Forward voltage	$V_{SD}^{*4}$	$V_{GS} = 0V, I_s = 100mA$	-	-	1.2	V

●Electrical characteristic curves

Fig.1 Power Dissipation Derating Curve

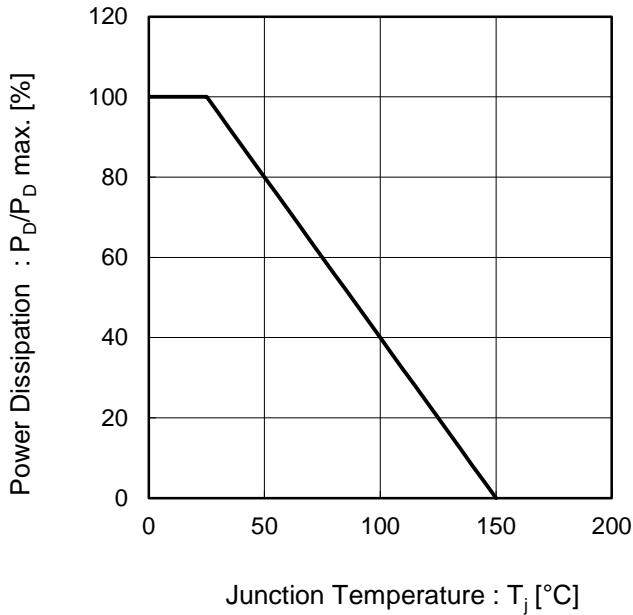

Fig.2 Drain Current Derating Curve

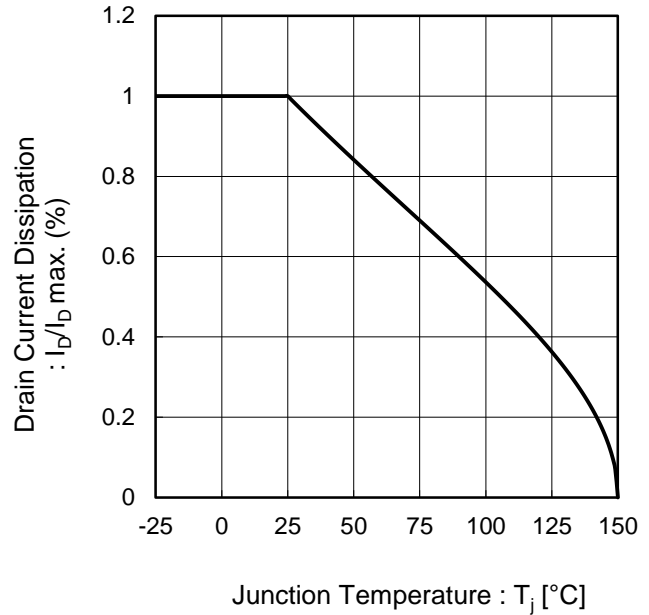

Fig.3 Typical Output Characteristics(I)

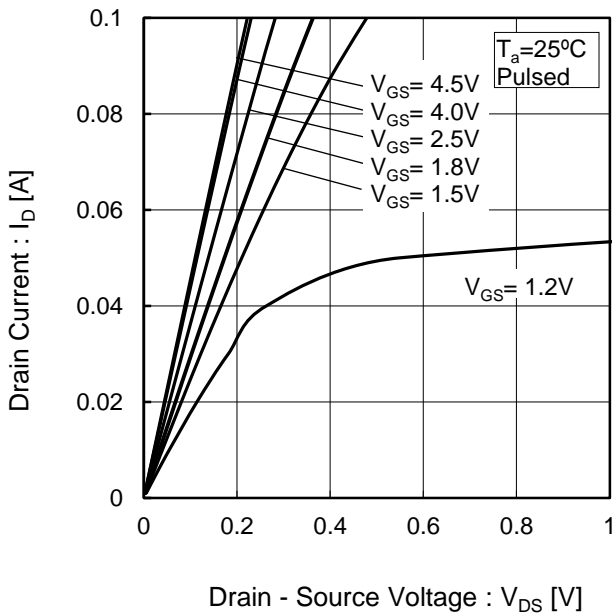
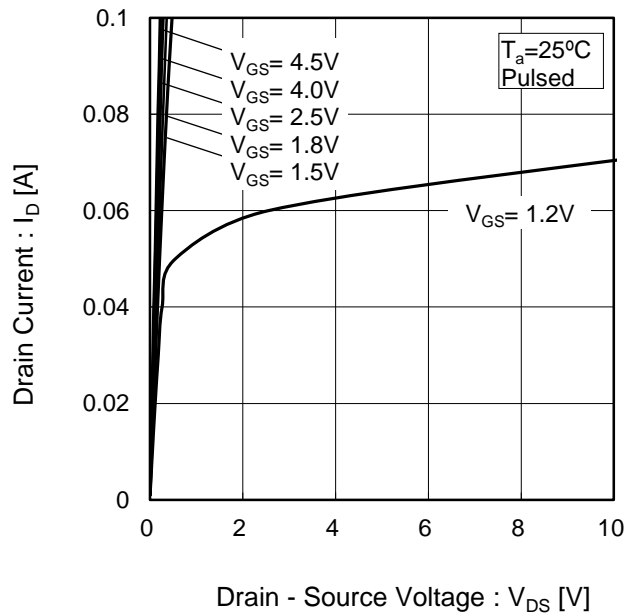

Fig.4 Typical Output Characteristics(II)



●Electrical characteristic curves

Fig.5 Breakdown Voltage vs. Junction Temperature

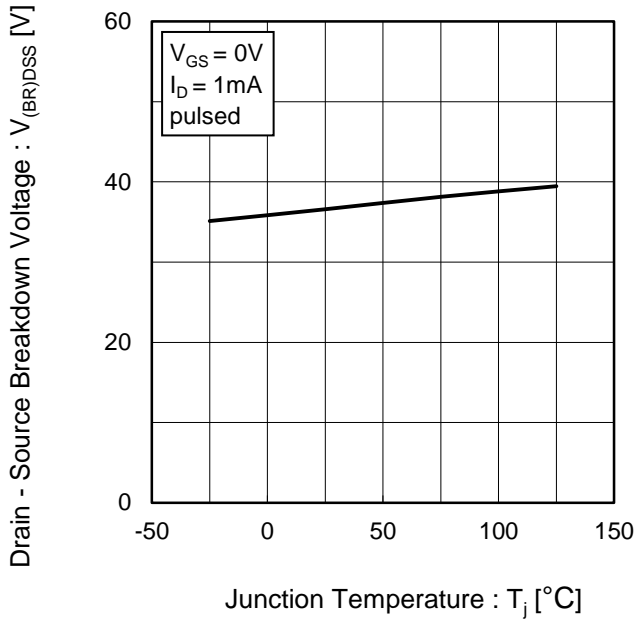

Fig.6 Typical Transfer Characteristics

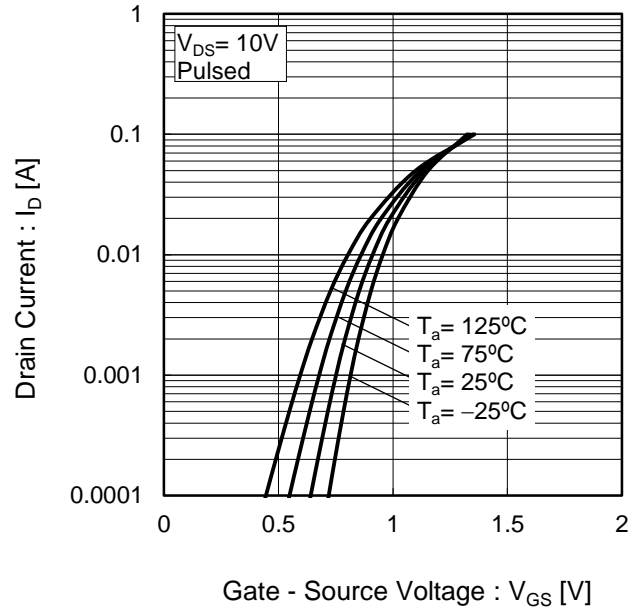

Fig.7 Gate Threshold Voltage vs. Junction Temperature

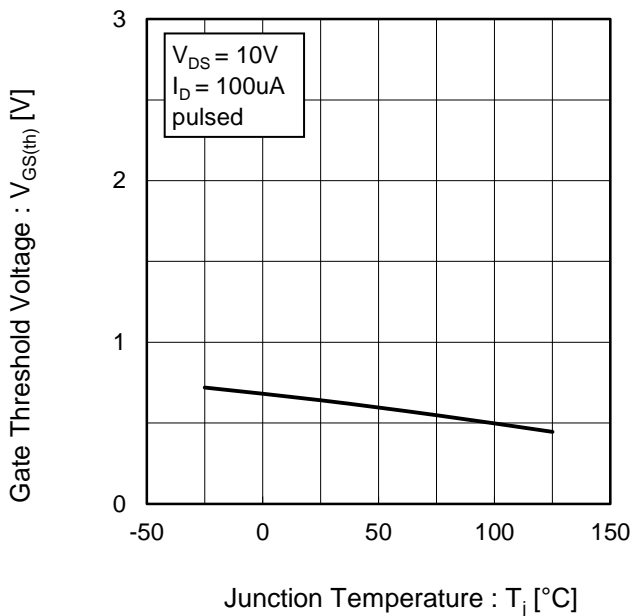
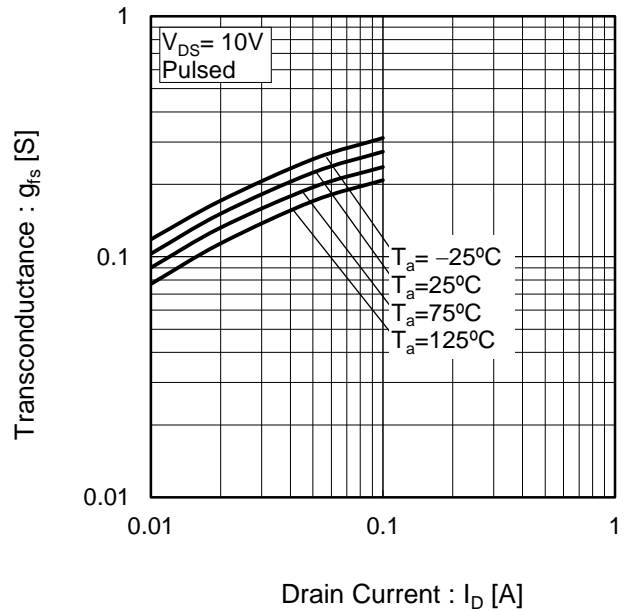

Fig.8 Transconductance vs. Drain Current



●Electrical characteristic curves

Fig.9 Static Drain - Source On - State Resistance vs. Gate Source Voltage

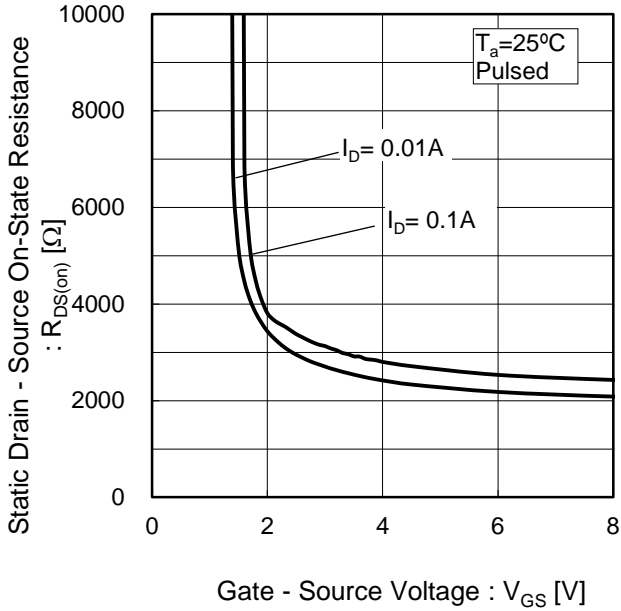

Fig.10 Static Drain - Source On - State Resistance vs. Drain Current(I)

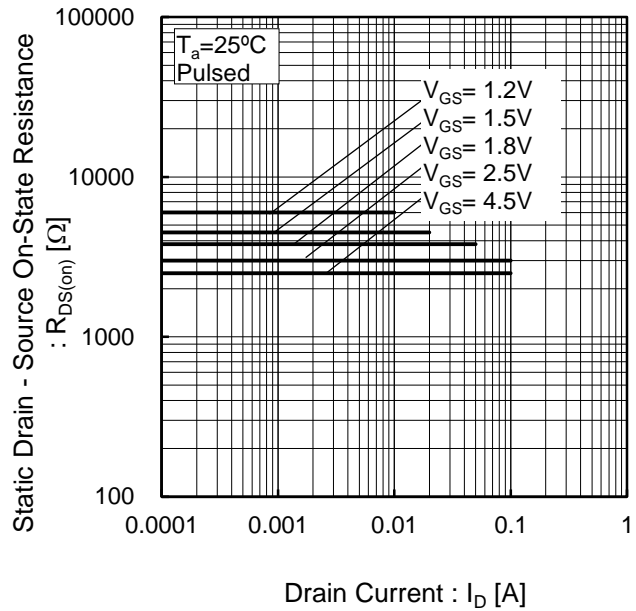

Fig.11 Static Drain - Source On - State Resistance vs. Junction Temperature

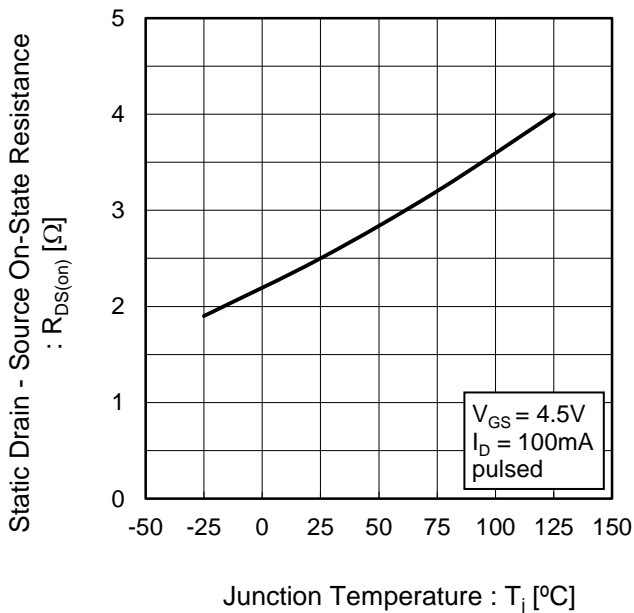
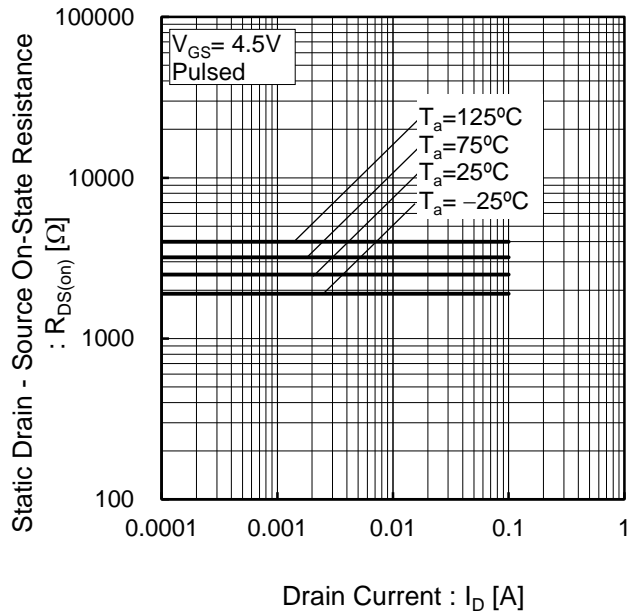

Fig.12 Static Drain - Source On - State Resistance vs. Drain Current(II)



●Electrical characteristic curves

Fig.13 Static Drain-Source On-State Resistance vs. Drain Current(III)

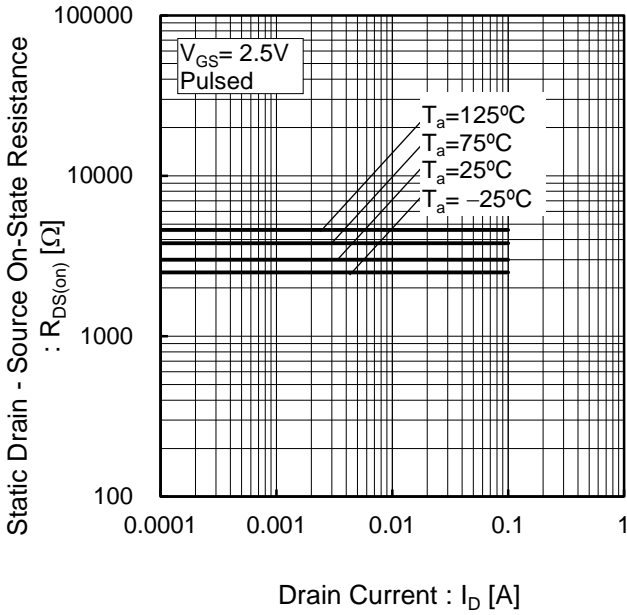

Fig.14 Static Drain - Source On - State Resistance vs. Drain Current(IV)

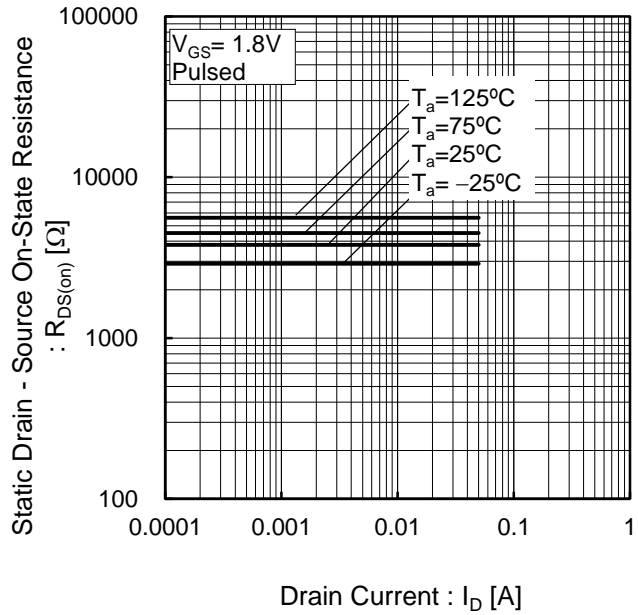

Fig.15 Static Drain - Source On - State Resistance vs. Drain Current(V)

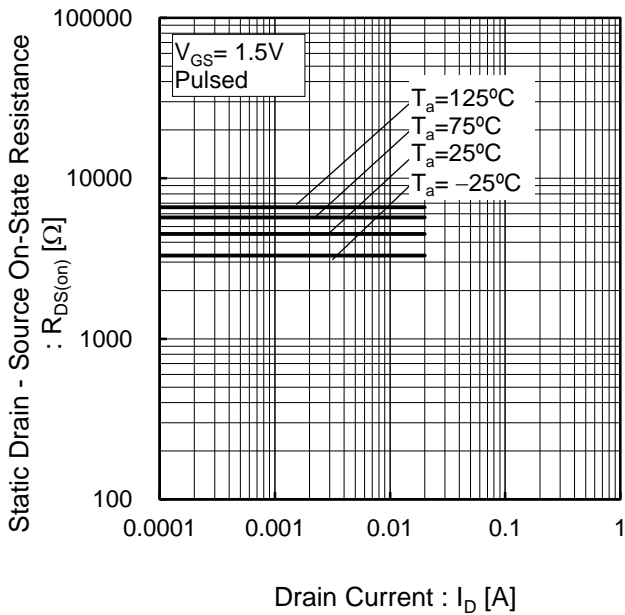
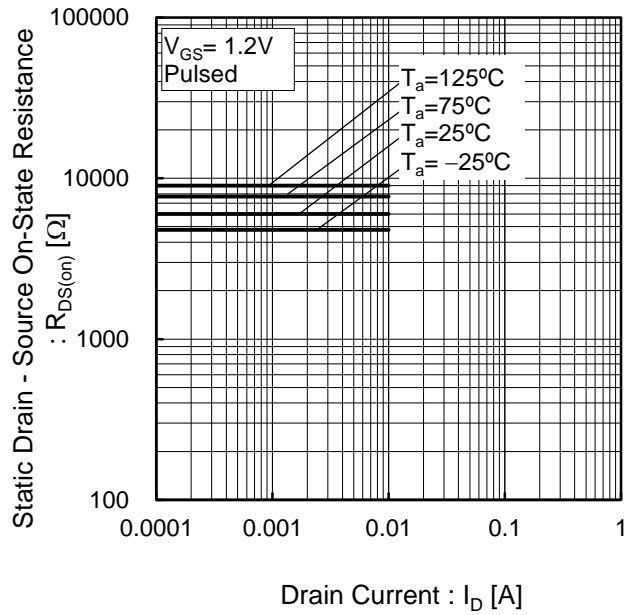

Fig.16 Static Drain - Source On - State Resistance vs. Drain Current(VI)



●Electrical characteristic curves

Fig.17 Typical Capacitance vs. Drain - Source Voltage

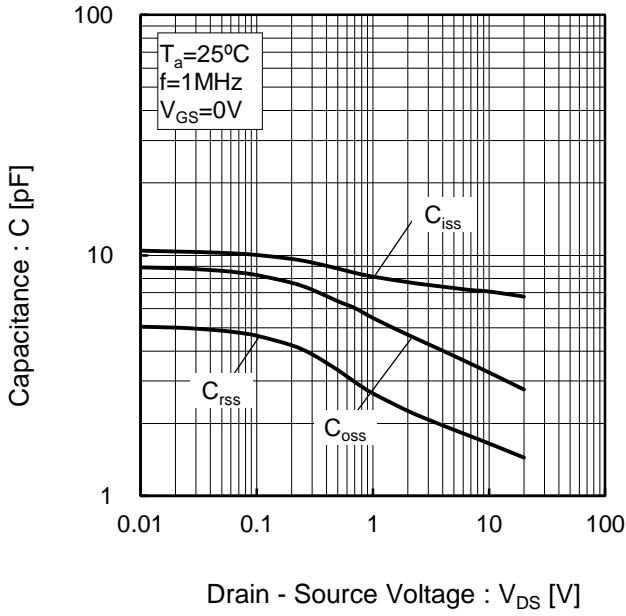

Fig.18 Switching Characteristics

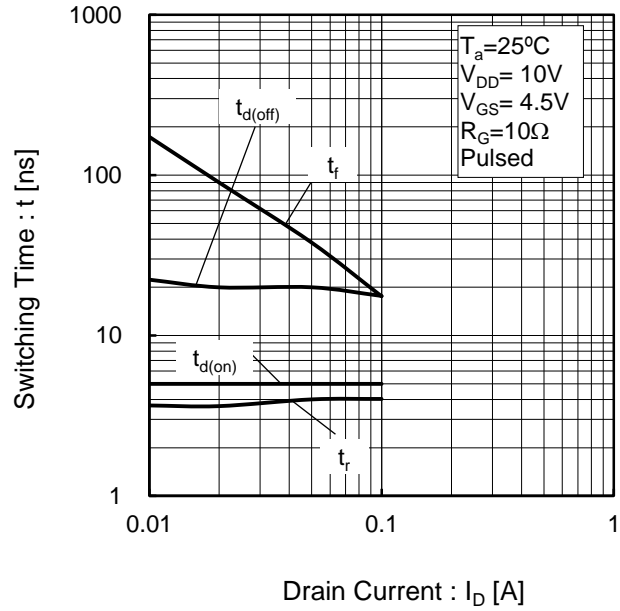
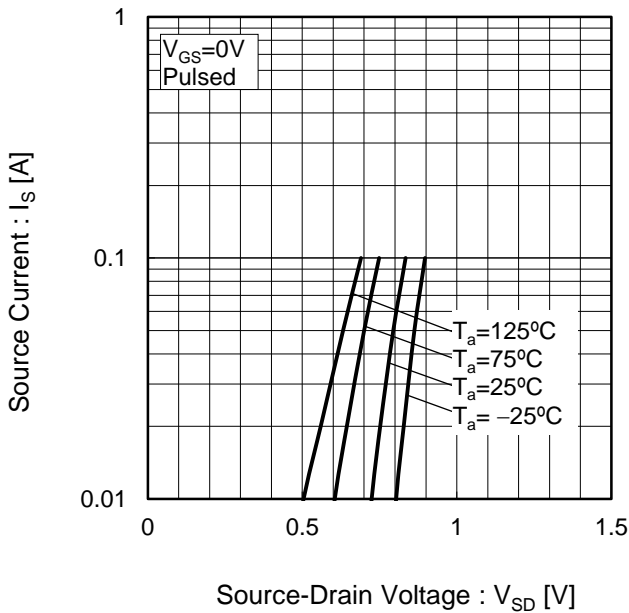

Fig.19 Source Current vs. Source Drain Voltage





●Measurement circuits

Fig.1-1 Switching Time Measurement Circuit

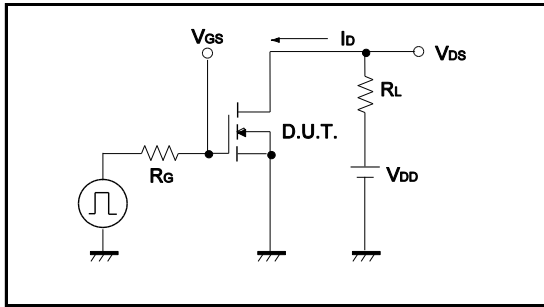
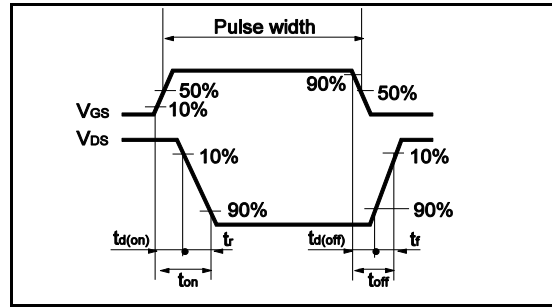

Fig.1-2 Switching Waveforms



●Notice

This product might cause chip aging and breakdown under the large electrified environment.  
Please consider to design ESD protection circuit.

●Dimensions (Unit : mm)

UMT3F

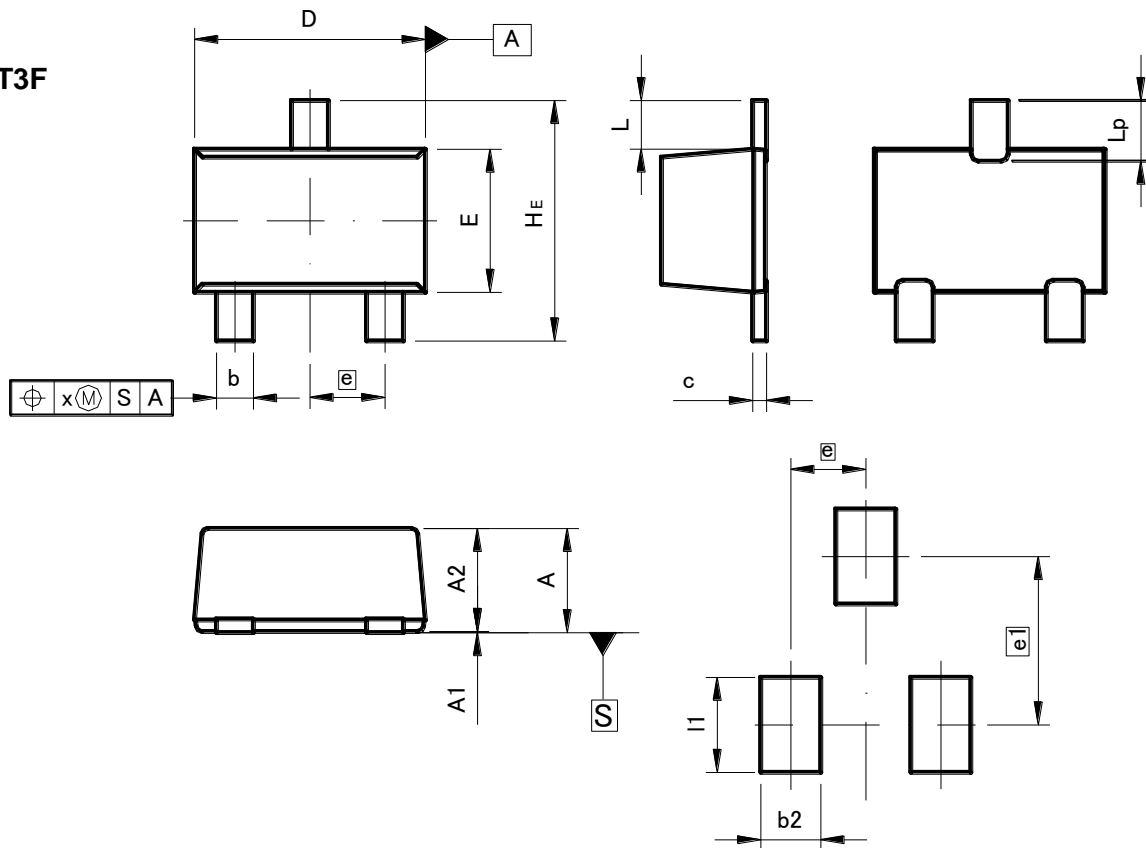

Pattern of terminal position areas

DIM	MILIMETERS		INCHES	
	MIN	MAX	MIN	MAX
A	0.85	1.05	0.033	0.041
A1	0.00	0.10	0	0.004
A2	0.80	1.00	0.031	0.039
b	0.27	0.42	0.011	0.017
c	0.08	0.18	0.003	0.007
D	1.90	2.10	0.075	0.083
E	1.15	1.35	0.045	0.053
e	0.65		0.03	
HE	2.00	2.20	0.079	0.087
L	0.425		0.02	
Lp	0.43	0.63	0.017	0.025
x	-	0.10	-	0.004

DIM	MILIMETERS		INCHES	
	MIN	MAX	MIN	MAX
e1	1.47		0.058	
b2	-	0.52	-	0.02
l1	-	0.83	-	0.033

Dimension in mm/inches

## Notes

No copying or reproduction of this document, in part or in whole, is permitted without the consent of ROHM Co.,Ltd.

The content specified herein is subject to change for improvement without notice.

The content specified herein is for the purpose of introducing ROHM's products (hereinafter "Products"). If you wish to use any such Product, please be sure to refer to the specifications, which can be obtained from ROHM upon request.

Examples of application circuits, circuit constants and any other information contained herein illustrate the standard usage and operations of the Products. The peripheral conditions must be taken into account when designing circuits for mass production.

Great care was taken in ensuring the accuracy of the information specified in this document. However, should you incur any damage arising from any inaccuracy or misprint of such information, ROHM shall bear no responsibility for such damage.

The technical information specified herein is intended only to show the typical functions of and examples of application circuits for the Products. ROHM does not grant you, explicitly or implicitly, any license to use or exercise intellectual property or other rights held by ROHM and other parties. ROHM shall bear no responsibility whatsoever for any dispute arising from the use of such technical information.

The Products specified in this document are intended to be used with general-use electronic equipment or devices (such as audio visual equipment, office-automation equipment, communication devices, electronic appliances and amusement devices).

The Products specified in this document are not designed to be radiation tolerant.

While ROHM always makes efforts to enhance the quality and reliability of its Products, a Product may fail or malfunction for a variety of reasons.

Please be sure to implement in your equipment using the Products safety measures to guard against the possibility of physical injury, fire or any other damage caused in the event of the failure of any Product, such as derating, redundancy, fire control and fail-safe designs. ROHM shall bear no responsibility whatsoever for your use of any Product outside of the prescribed scope or not in accordance with the instruction manual.

The Products are not designed or manufactured to be used with any equipment, device or system which requires an extremely high level of reliability the failure or malfunction of which may result in a direct threat to human life or create a risk of human injury (such as a medical instrument, transportation equipment, aerospace machinery, nuclear-reactor controller, fuel-controller or other safety device). ROHM shall bear no responsibility in any way for use of any of the Products for the above special purposes. If a Product is intended to be used for any such special purpose, please contact a ROHM sales representative before purchasing.

If you intend to export or ship overseas any Product or technology specified herein that may be controlled under the Foreign Exchange and the Foreign Trade Law, you will be required to obtain a license or permit under the Law.



Thank you for your accessing to ROHM product informations.  
More detail product informations and catalogs are available, please contact us.

### ROHM Customer Support System

<http://www.rohm.com/contact/>