

●Features

- High brightness
- 20/50mA guaranteed specifications
- PLCC2 package

●Size

Actual size
3528 (1411)
3.5 × 2.8mm (t=1.9mm)



●Outline



●Dimensions

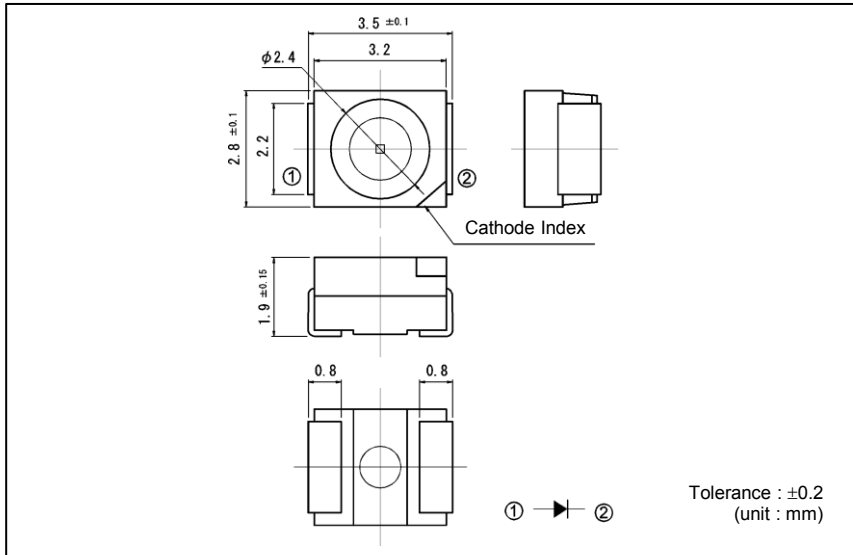

●Recommended Solder Pattern

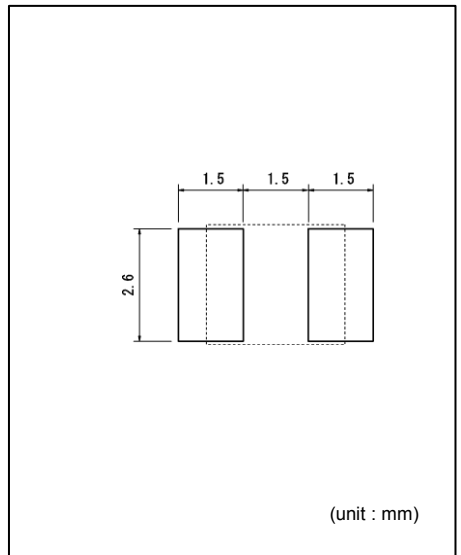

●Specifications

Part No.	Chip Structure	Emitting Color	Absolute Maximum Ratings (Ta=25°C)					Electrical and Optical Characteristics (Ta=25°C)												
			Power Dissipation P ₀ (mW)	Forward Current I _F (mA)	Peak Forward Current I _{FP} (mA)	Reverse Voltage V _R (V)	Operating Temp. Topr(°C)	Storage Temp. Tstg(°C)	Forward Voltag V _F Typ. (V)	I _F (mA)	Reverse Current I _R (μA)	V _R (V)	Dominant Wavelength λ _D			Luminous Intensity I _v				
								Max.	Max.	Max.	Min. ^{*3}	Typ.	Max. ^{*3}	I _F (mA)	Min.	Typ.	I _F (mA)			
SML-Z14VT(A)	AlGaInP	Red	168	70	200*1	12	-40 to +100	-40 to +100	1.9	20	10	12	625	630	635	20	56	112	20	
SML-Z14UT(A)		Orange											615	620	625		112	224		
SML-Z14DT(A)		Yellow											602	605	608		140	280		
SML-Z14YT(A)		Yellowish Green	175	70	200*1	12	-40 to +100	-40 to +100	2.0	20	10	12	586	589	592	20	45	90	20	
SML-Z14MT(A)		Green											561.5	564	566.5		22.4	45		
SML-Z14FT(A)		Green											557	560	563		11.2	22.4		
SML-Z14PT(A)		Green	557	560	563	11.2	22.4													
SML-Z14V4T		InGaN	Red	189	70	200*1	12	-40 to +100	-40 to +100	2.0	50	100	12	625	630	635	50	140	280	50
SML-Z14U4T			Orange											615	620	625		280	560	
SML-Z14D4T			Yellow											602	605	608		355	710	
SML-Z14Y4T			Yellowish Green	189	70	200*1	12	-40 to +100	-40 to +100	2.1	50	100	12	587	590	593	50	112	224	50
SML-Z14M4T			Green											569	572	575		71	120	
SML-Z14F4T			Green											562	565	568		22.4	56	
SML-Z14P4T			Green	558	561	564	22.4	56												
SMLZ14EGT(A)	InGaN		Bluish Green	120	30	100*2	5	-40 to +100	-40 to +100	3.3	20	10	5	519	528	536	20	710	1100	20
SMLZ14BGT(A)			Blue							3.2				464	470	476		140	280	
SMLZ14WBG CW(A)			White	114	30	100*2	5	-40 to +100	-40 to +100	3.3	20	100	5	(x, y) (0.30, 0.28)		20	1800	2200	20	
SMLZ14WBG DW(A)														(x, y) (0.34, 0.34)			2200	3200		

*1:Duty1/10, 1kHz *2:Duty1/5, 200Hz *3:Reference

●Electrical Characteristics Curves

Fig.1 Forward Current - Forward Voltages

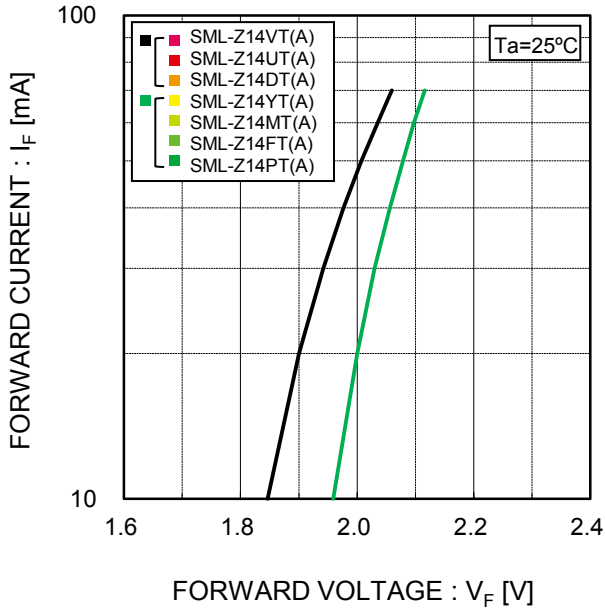

Fig.2 Luminous Intensity - Atmosphere Temperature

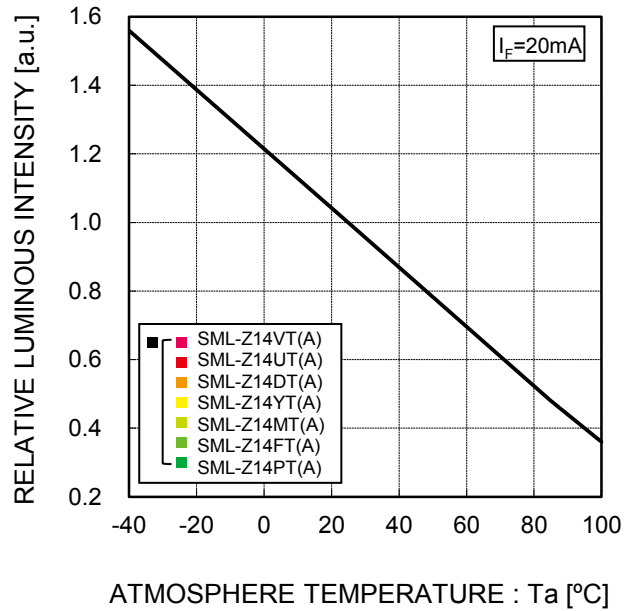

Fig.3 Luminous Intensity - Forward Current

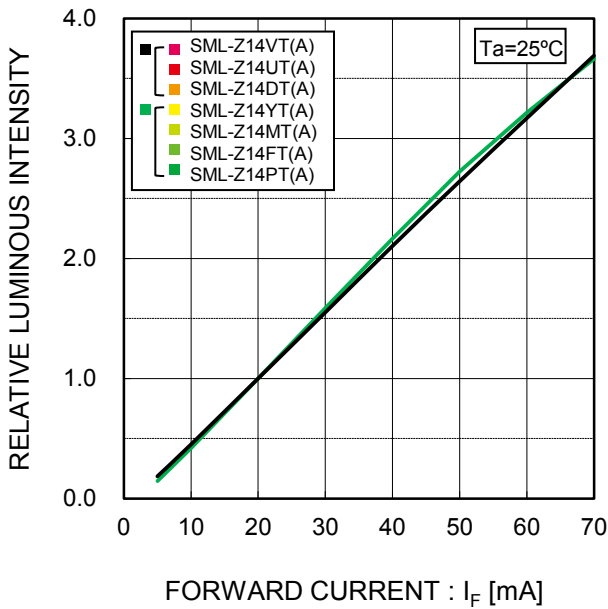
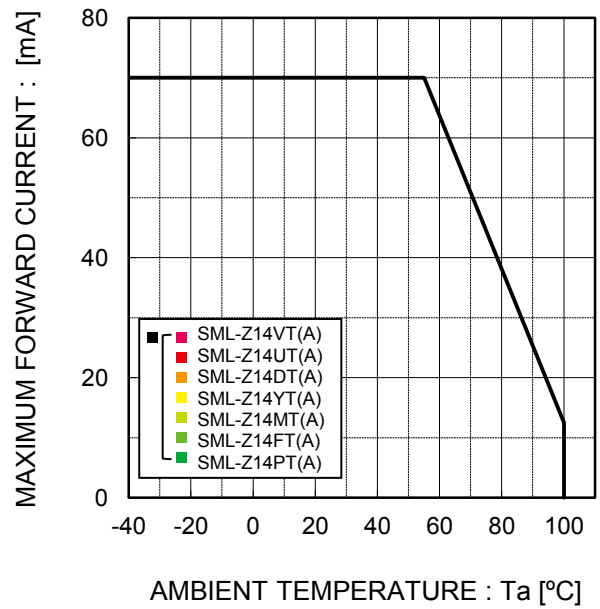

Fig.4 Derating



●Electrical Characteristics Curves

Fig.1 Forward Current - Forward Voltages

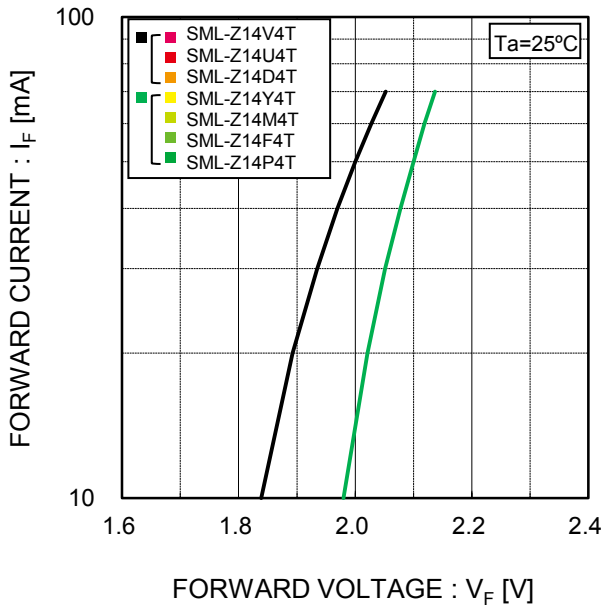

Fig.2 Luminous Intensity - Atmosphere Temperature

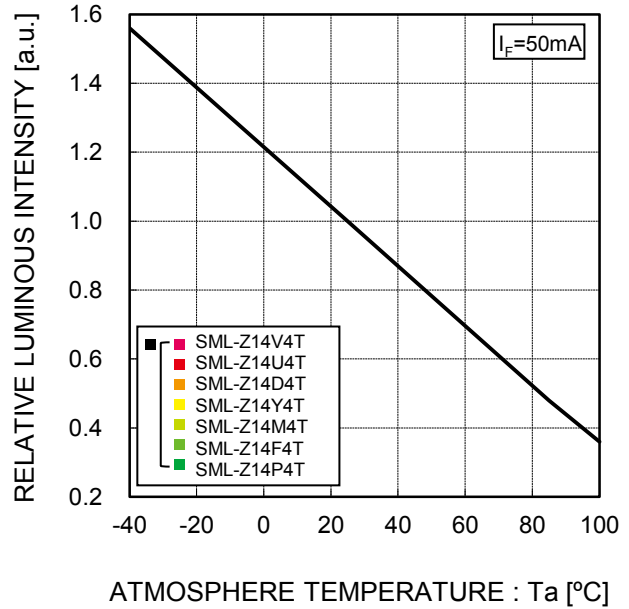

Fig.3 Luminous Intensity - Forward Current

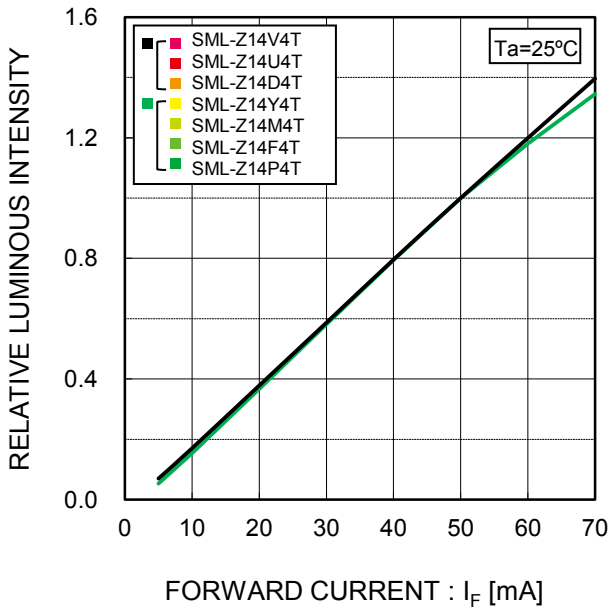
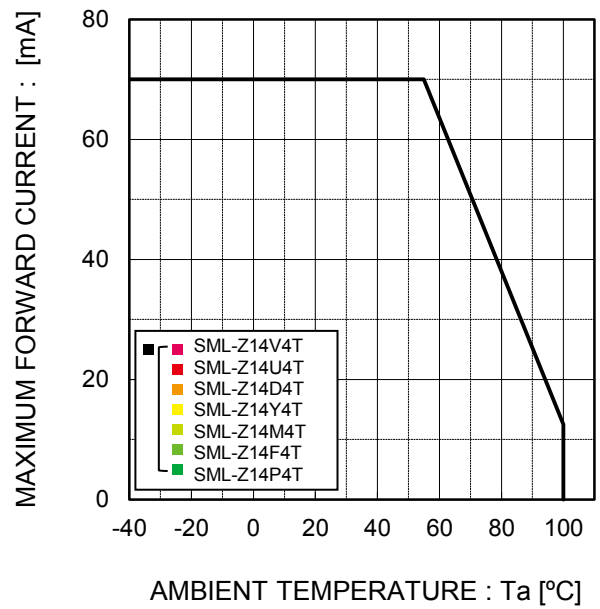

Fig.4 Derating



●Electrical Characteristics Curves

Fig.1 Forward Current - Forward Voltages

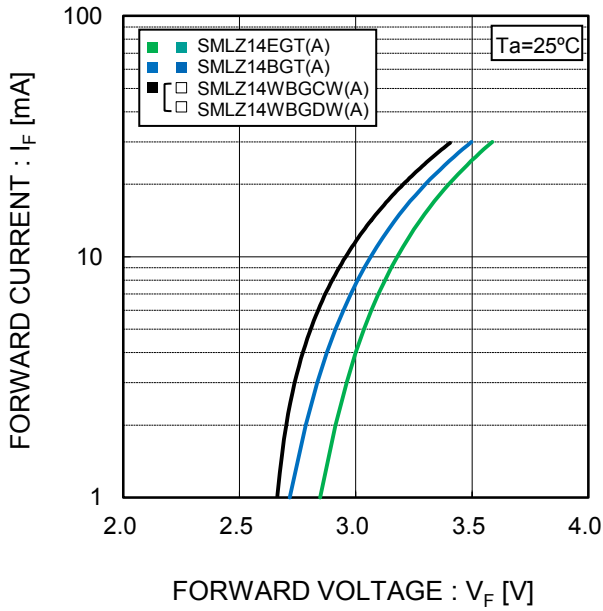

Fig.2 Luminous Intensity - Atmosphere Temperature

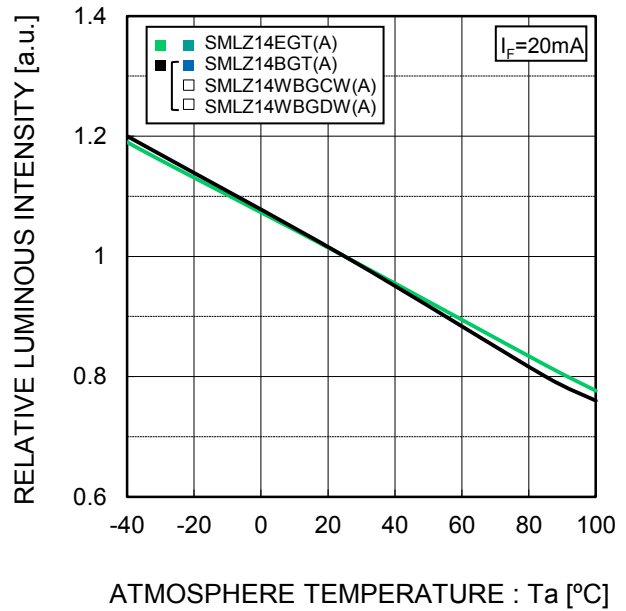

Fig.3 Luminous Intensity - Forward Current

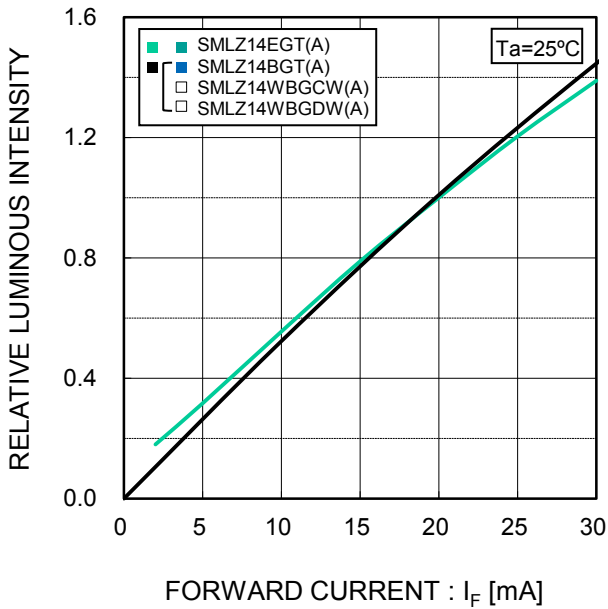
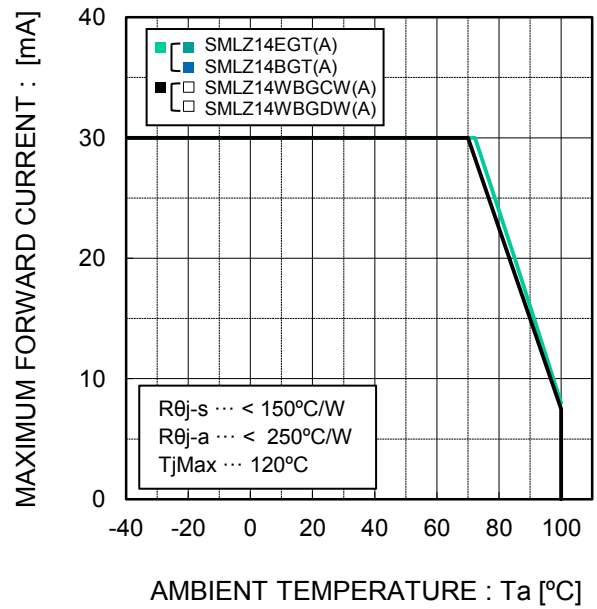
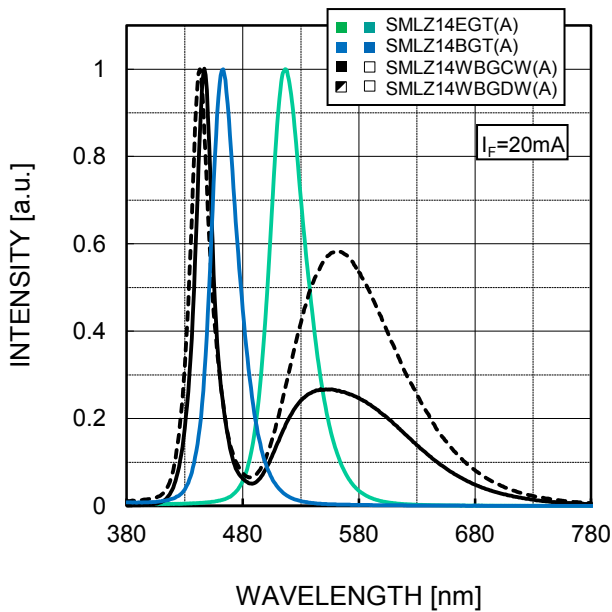
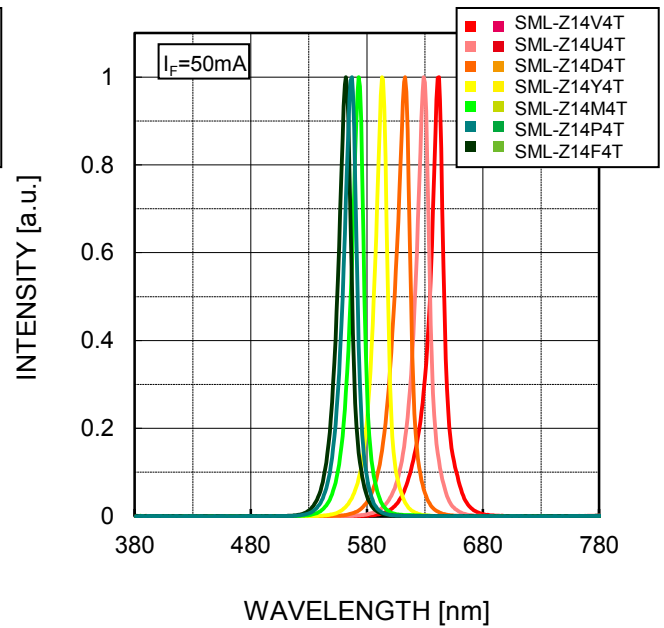
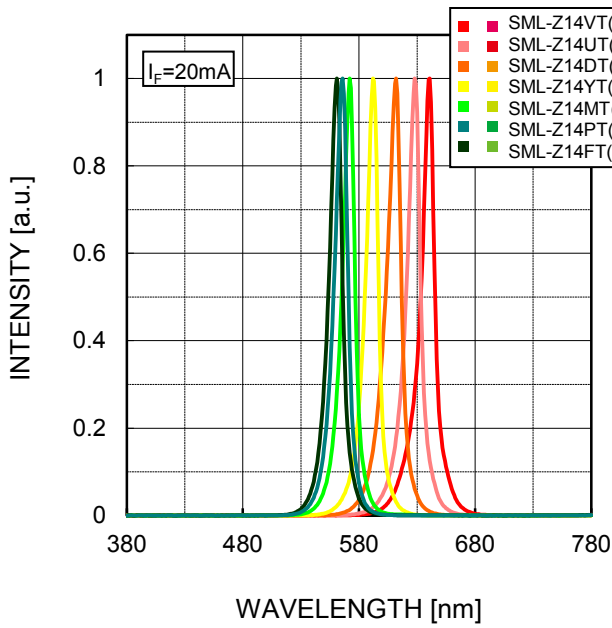

Fig.4 Derating



● Spectrum Data



* Please take this data as a reference data for the samples are measured randomly.
 * The data is relativized for each color. It is NOT to show the spectrum peaks are equal.

● Viewing Angle

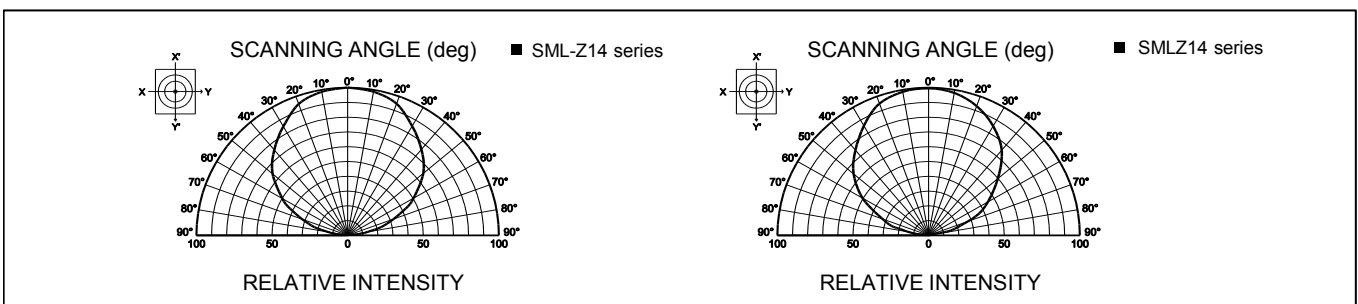

●Rank Reference of Brightness

Red(V,U)

(Ta=25°C, If=20mA)

Rank	AM	AN	AP	AQ	AR	AS	AT	AU	AV	AW	AX	AY	AZ	BA	BB	BC	BD	BE
Iv (mcd)	28 to 35.5	35.5 to 45	45 to 56	56 to 71	71 to 90	90 to 112	112 to 140	140 to 180	180 to 224	224 to 280	280 to 355	355 to 450	450 to 560	560 to 710	710 to 900	900 to 1120	1120 to 1400	1400 to 1800
SML-Z14VT(A)																		
SML-Z14UT(A)																		

(Ta=25°C, If=50mA)

Rank	AM	AN	AP	AQ	AR	AS	AT	AU	AV	AW	AX	AY	AZ	BA	BB	BC	BD	BE
Iv (mcd)	28 to 35.5	35.5 to 45	45 to 56	56 to 71	71 to 90	90 to 112	112 to 140	140 to 180	180 to 224	224 to 280	280 to 355	355 to 450	450 to 560	560 to 710	710 to 900	900 to 1120	1120 to 1400	1400 to 1800
SML-Z14V4T																		
SML-Z14U4T																		

Orange(D)

(Ta=25°C, If=20mA)

Rank	AM	AN	AP	AQ	AR	AS	AT	AU	AV	AW	AX	AY	AZ	BA	BB	BC	BD	BE
Iv (mcd)	28 to 35.5	35.5 to 45	45 to 56	56 to 71	71 to 90	90 to 112	112 to 140	140 to 180	180 to 224	224 to 280	280 to 355	355 to 450	450 to 560	560 to 710	710 to 900	900 to 1120	1120 to 1400	1400 to 1800
SML-Z14DT(A)																		

(Ta=25°C, If=50mA)

Rank	AM	AN	AP	AQ	AR	AS	AT	AU	AV	AW	AX	AY	AZ	BA	BB	BC	BD	BE
Iv (mcd)	28 to 35.5	35.5 to 45	45 to 56	56 to 71	71 to 90	90 to 112	112 to 140	140 to 180	180 to 224	224 to 280	280 to 355	355 to 450	450 to 560	560 to 710	710 to 900	900 to 1120	1120 to 1400	1400 to 1800
SML-Z14D4T																		

Yellow(Y)

(Ta=25°C, If=20mA)

Rank	AM	AN	AP	AQ	AR	AS	AT	AU	AV	AW	AX	AY	AZ	BA	BB	BC	BD	BE
Iv (mcd)	28 to 35.5	35.5 to 45	45 to 56	56 to 71	71 to 90	90 to 112	112 to 140	140 to 180	180 to 224	224 to 280	280 to 355	355 to 450	450 to 560	560 to 710	710 to 900	900 to 1120	1120 to 1400	1400 to 1800
SML-Z14YT(A)																		

(Ta=25°C, If=50mA)

Rank	AM	AN	AP	AQ	AR	AS	AT	AU	AV	AW	AX	AY	AZ	BA	BB	BC	BD	BE
Iv (mcd)	28 to 35.5	35.5 to 45	45 to 56	56 to 71	71 to 90	90 to 112	112 to 140	140 to 180	180 to 224	224 to 280	280 to 355	355 to 450	450 to 560	560 to 710	710 to 900	900 to 1120	1120 to 1400	1400 to 1800
SML-Z14Y4T																		

Green(M,P)

(Ta=25°C, If=20mA)

Rank	AG	AH	AJ	AK	AL	AM	AN	AP	AQ	AR	AS	AT	AU	AV	AW	AX	AY	AZ
Iv (mcd)	9 to 11.2	11.2 to 14	14 to 18	18 to 22.4	22.4 to 28	28 to 35.5	35.5 to 45	45 to 56	56 to 71	71 to 90	90 to 112	112 to 140	140 to 180	180 to 224	224 to 280	280 to 355	355 to 450	450 to 560
SML-Z14MT(A)																		
SML-Z14PT(A)																		
SML-Z14FT(A)																		

(Ta=25°C, If=50mA)

Rank	AG	AH	AJ	AK	AL	AM	AN	AP	AQ	AR	AS	AT	AU	AV	AW	AX	AY	AZ
Iv (mcd)	9 to 11.2	11.2 to 14	14 to 18	18 to 22.4	22.4 to 28	28 to 35.5	35.5 to 45	45 to 56	56 to 71	71 to 90	90 to 112	112 to 140	140 to 180	180 to 224	224 to 280	280 to 355	355 to 450	450 to 560
SML-Z14M4T																		
SML-Z14P4T																		
SML-Z14F4T																		

Bluish Green(E)

(Ta=25°C, If=20mA)

Rank	S1	S2	T1	T2	U1	U2	V1	V2	W1	W2	X1	X2	Y1	Y2	Z1	Z2
Iv (mcd)	90 to 110	110 to 140	140 to 180	180 to 220	220 to 280	280 to 360	360 to 450	450 to 560	560 to 710	710 to 900	900 to 1100	1100 to 1400	1400 to 1800	1800 to 2200	2200 to 2800	2800 to 3600
SMLZ14EGT(A)																

Blue(B)

(Ta=25°C, If=20mA)

Rank	S1	S2	T1	T2	U1	U2	V1	V2	W1	W2	X1	X2	Y1	Y2	Z1	Z2
Iv (mcd)	90 to 110	110 to 140	140 to 180	180 to 220	220 to 280	280 to 360	360 to 450	450 to 560	560 to 710	710 to 900	900 to 1100	1100 to 1400	1400 to 1800	1800 to 2200	2200 to 2800	2800 to 3600
SMLZ14BGT(A)																

White(WB)

(Ta=25°C, If=20mA)

Rank	S1	S2	T1	T2	U1	U2	V1	V2	W1	W2	X1	X2	Y1	Y2	Z1	Z2
Iv (mcd)	90 to 110	110 to 140	140 to 180	180 to 220	220 to 280	280 to 360	360 to 450	450 to 560	560 to 710	710 to 900	900 to 1100	1100 to 1400	1400 to 1800	1800 to 2200	2200 to 2800	2800 to 3600
SMLZ14WBCW(A)																
SMLZ14WBGDW(A)																

*Please note that the brightness of some products may fall between ranks (half rank).

●Chromaticity Diagram

SMLZ14WBGW1(A)

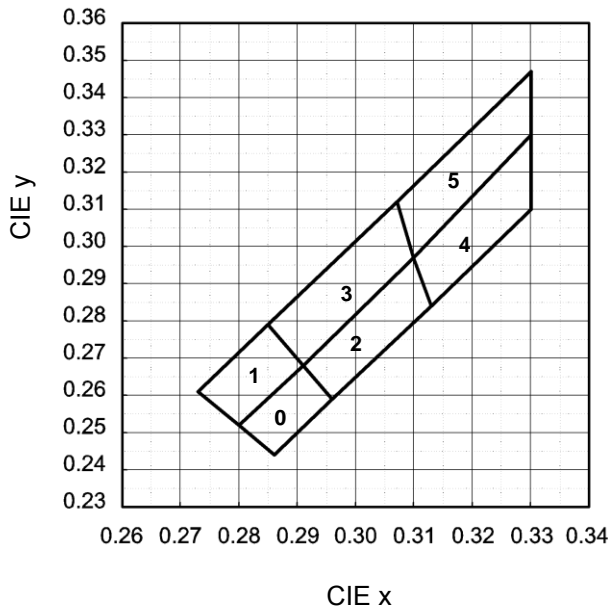

[Chromaticity Coordinates] (Ta=25°C, If=20mA)

0		1		2	
x	y	x	y	x	y
0.286	0.244	0.280	0.252	0.296	0.259
0.280	0.252	0.273	0.261	0.291	0.268
0.291	0.268	0.285	0.279	0.310	0.297
0.296	0.259	0.291	0.268	0.313	0.284

3		4		5	
x	y	x	y	x	y
0.291	0.268	0.313	0.284	0.310	0.297
0.285	0.279	0.310	0.297	0.307	0.312
0.307	0.312	0.330	0.330	0.330	0.347
0.310	0.297	0.330	0.310	0.330	0.330

Measurement tolerance : ±0.02

SMLZ14WBGDW1(A)

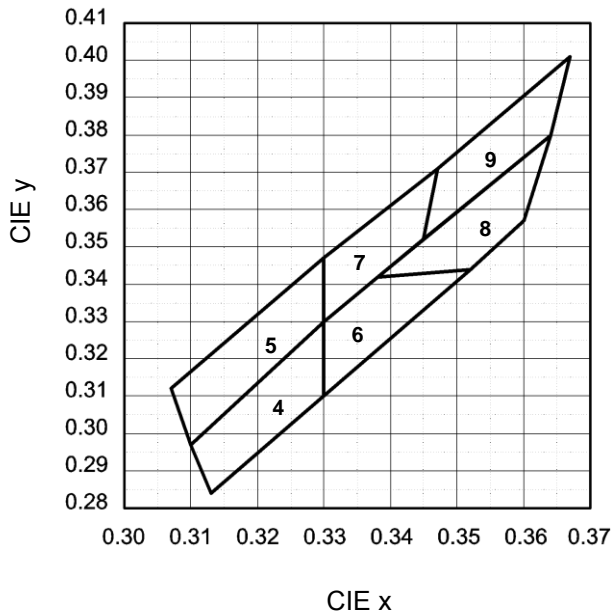

[Chromaticity Coordinates] (Ta=25°C, If=20mA)

4		5		6	
x	x	x	y	x	y
0.313	0.284	0.310	0.297	0.330	0.310
0.310	0.297	0.307	0.312	0.330	0.330
0.330	0.330	0.330	0.347	0.338	0.342
0.330	0.310	0.330	0.330	0.352	0.344

7		8		9	
x	y	x	y	x	y
0.330	0.330	0.352	0.344	0.345	0.352
0.330	0.347	0.338	0.342	0.347	0.371
0.347	0.371	0.364	0.380	0.367	0.401
0.345	0.352	0.360	0.357	0.364	0.380

Measurement tolerance : ±0.02

●Taping

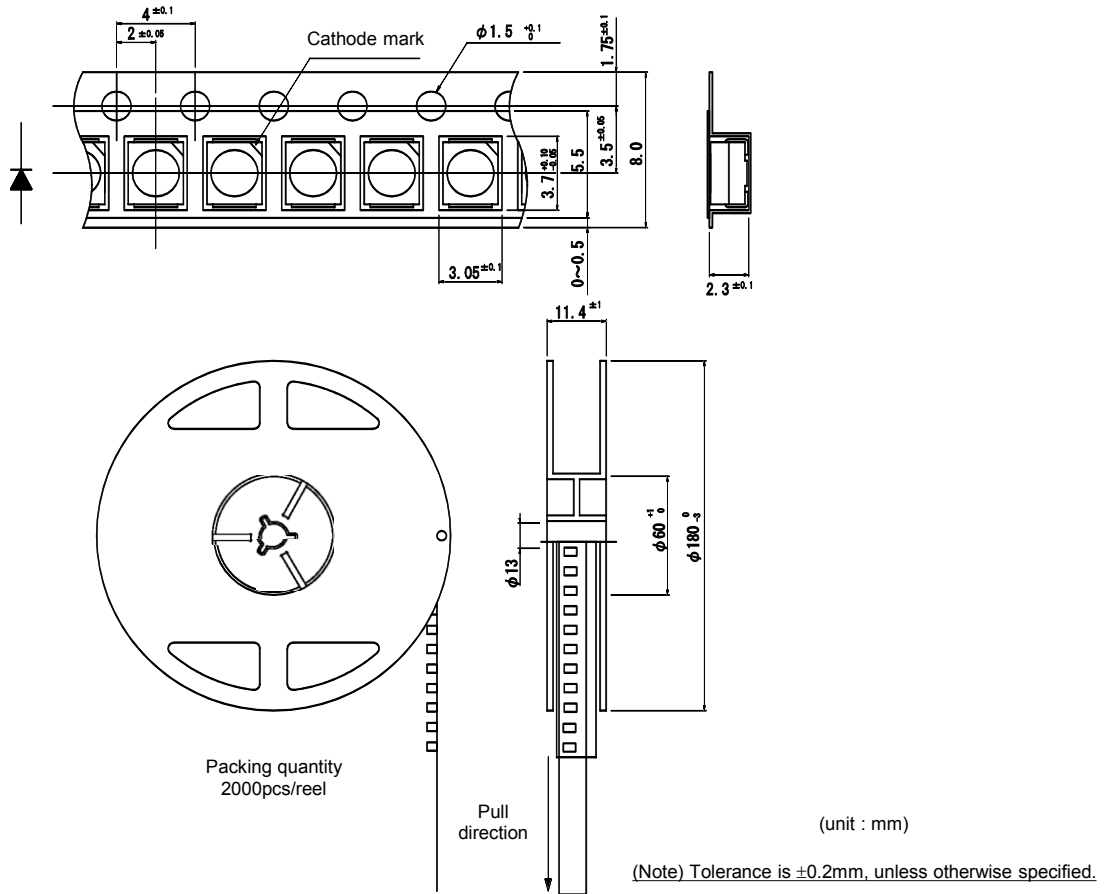

●Part No. Construction

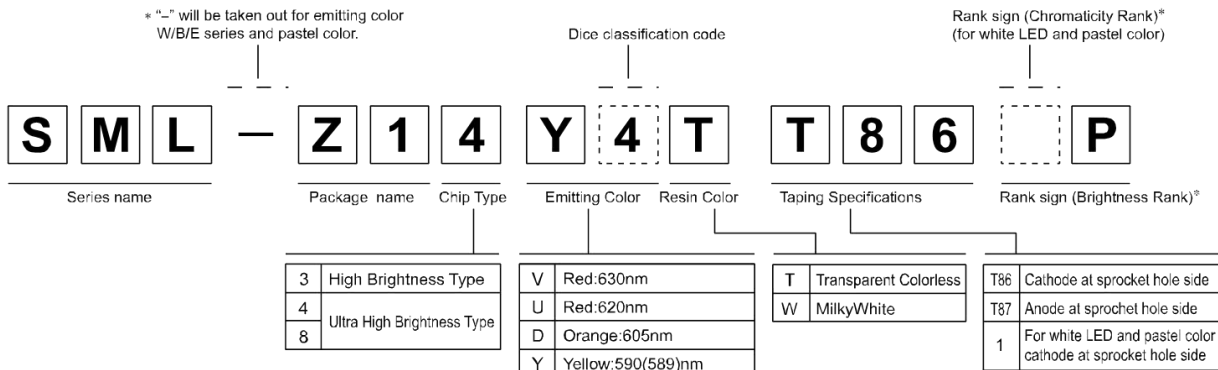

※ Concerning the rank sign.
 • Please refer to the rank chart above for luminous intensity classification.
 • Please refer to specification sheet for color classification.
 • Part name is individual for each rank.
 • When shipped as sample, the part name will be a representative part name.
 General products are free of ranks. Please contact sales if rank appointment is needed.

●Packing Specification

ROHM LED products are being shipped with desiccant (silica gel) concluded in moisture-proof bags.

Pasting the moisture sensitive label on the outer surface of the moisture-proof bags or enclosing the humidity indication card inside the bag is available upon request.

Please contact the nearest sales office or distributor if necessary.

●Attention Points In Handling

This product was developed as a surface mount LED especially suitable for reflow soldering. Please take care of following points when using this device.

1.DESIGNING OF PCB

As for a recommendable solder pattern, Please refer to Fig-1.
 The size and direction of the pad pattern depends on the condition of the PCB,
 So, please investigate about the adjustment thoroughly before designing.

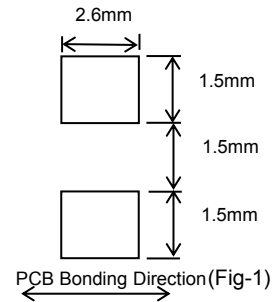

2.SOLDERING (Sn-Cu, Sn-Ag-Cu, Sn-Ag-Bi-Cu)

LED products do not contain reinforcement materials such as glass fillers. Therefore, thermal stress by soldering greatly influence its reliability. The temperature conditions for reflow soldering should therefore be set up according to the characteristic of this product. (See Fig-2)
 Number of reflow process shall be max 2 times and these processes shall be performed in a row. Cooling process to normal temperature shall be required between first and second soldering process.

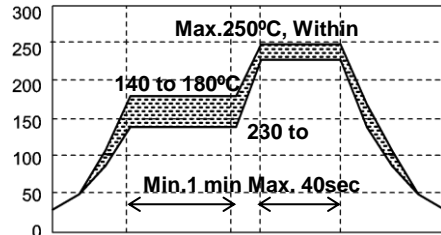

(Fig-2)

3.USE OF AUTOMATIC MOUNTING MACHINE

As for this product, the silicone resin is used as encapsulate material and the sealing part on top of LED is soft. Therefore, please make sure not to apply the pressure upon it, as it might influence reliability. Moreover, please use the adsorption nozzle when you use the automatic mounting machine so as not to apply the force directly to this top sealing part.

4.HANDLING AFTER MOUNTING

As shown right drawing, in case outside force is given to the device, stress is concentrated to the jointed part between mold resin and substrate. Therefore there is a possibility to breath the device or PCB. Careful handling is needed as ROHM cannot guarantee the falling of the device by outside force after mounting.

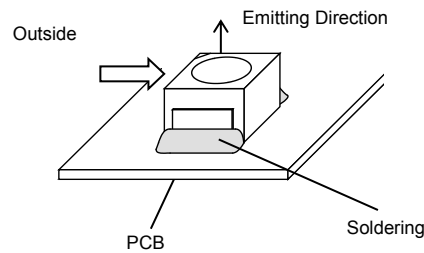

5.WASHING

Please note the following points when washing is required after soldering.

5-1) WASHING SOLVENT

Isopropyl alcohol or other alcohol solvent is recommendable.

5-2) TEMPERATURE

Below 30°C, immersion time ; within 3 minutes.

5-3) ULTRA SONIC WASHING

Below 15/1 litter of solvent tub.

5-4) COOLING

Below 100°C within 3 minutes.

6.EROSION GAS

Utilization in erosion gas atmosphere may degenerate the plating surface which might cause deterioration of solder strength, optical characteristics, or functions.

Please take precautions against occurrence of gas from the surrounding parts on the occasion of custody, and also after mounted on circuit board.

7.STORAGE

At reflow soldering, the reliability of this product is often influenced by moisture absorption so we apply the packaging with moisture proof for better condition is use, please also note that

7-1) Not to be opened before using.

7-2) To be kept in our moisture proof packaging with some desiccant (SILICA GEL) after opening it.

To be baked in case the SILICA GEL indicator changed its color from either blue to clear or green to pink.

7-3) Please use within 72 hours after the package was opened. (Condition at 30°C, max.70%Rh.)

In case it is not used within 72 hours, please put it back into our packaging.

7-4) BAKING

Please bake under reel condition at 60°C, 40~48 hours (max.20%Rh) after un-sealing.

While baking is done, the reel and emboss tape may be easily deformed.

Please be careful not to give any stress.

7.LIFE TIME

This product will cause reduction of luminous intensity depending on the using conditions and environmental.

Please inquire our sales contact if long life time is required on your application.

Notes

- 1) The information contained herein is subject to change without notice.
- 2) Before you use our Products, please contact our sales representative and verify the latest specifications :
- 3) Although ROHM is continuously working to improve product reliability and quality, semiconductors can break down and malfunction due to various factors.
Therefore, in order to prevent personal injury or fire arising from failure, please take safety measures such as complying with the derating characteristics, implementing redundant and fire prevention designs, and utilizing backups and fail-safe procedures. ROHM shall have no responsibility for any damages arising out of the use of our Products beyond the rating specified by ROHM.
- 4) Examples of application circuits, circuit constants and any other information contained herein are provided only to illustrate the standard usage and operations of the Products. The peripheral conditions must be taken into account when designing circuits for mass production.
- 5) The technical information specified herein is intended only to show the typical functions of and examples of application circuits for the Products. ROHM does not grant you, explicitly or implicitly, any license to use or exercise intellectual property or other rights held by ROHM or any other parties. ROHM shall have no responsibility whatsoever for any dispute arising out of the use of such technical information.
- 6) The Products are intended for use in general electronic equipment (i.e. AV/OA devices, communication, consumer systems, gaming/entertainment sets) as well as the applications indicated in this document.
- 7) The Products specified in this document are not designed to be radiation tolerant.
- 8) For use of our Products in applications requiring a high degree of reliability (as exemplified below), please contact and consult with a ROHM representative : transportation equipment (i.e. cars, ships, trains), primary communication equipment, traffic lights, fire/crime prevention, safety equipment, medical systems, servers, solar cells, and power transmission systems.
- 9) Do not use our Products in applications requiring extremely high reliability, such as aerospace equipment, nuclear power control systems, and submarine repeaters.
- 10) ROHM shall have no responsibility for any damages or injury arising from non-compliance with the recommended usage conditions and specifications contained herein.
- 11) ROHM has used reasonable care to ensure the accuracy of the information contained in this document. However, ROHM does not warrant that such information is error-free, and ROHM shall have no responsibility for any damages arising from any inaccuracy or misprint of such information.
- 12) Please use the Products in accordance with any applicable environmental laws and regulations, such as the RoHS Directive. For more details, including RoHS compatibility, please contact a ROHM sales office. ROHM shall have no responsibility for any damages or losses resulting from non-compliance with any applicable laws or regulations.
- 13) When providing our Products and technologies contained in this document to other countries, you must abide by the procedures and provisions stipulated in all applicable export laws and regulations, including without limitation the US Export Administration Regulations and the Foreign Exchange and Foreign Trade Act.
- 14) This document, in part or in whole, may not be reprinted or reproduced without prior consent of ROHM.



Thank you for your accessing to ROHM product informations.
More detail product informations and catalogs are available, please contact us.

ROHM Customer Support System

<http://www.rohm.com/contact/>