

Sulfur Tolerant Chip Resistors

TRR Series

●Features

- 1) Special construction prevents sulfur gas penetration, significantly increasing reliability.
- 2) Highly recommended for automotive, industrial and Power supply applications under sulfur environment.
- 3) ROHM resistors have obtained ISO9001 / ISO / TS16949 certification.
- 4) Corresponds to AEC-Q200. (TRR03 / 10 / 18)

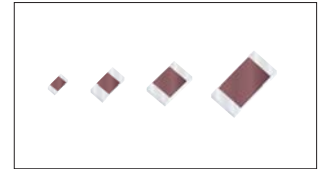

●Products List

Part No.	Size		Rated Power (70°C) (W)	Limiting Element Voltage (V)	Maximum Overload Voltage (V)	Temperature Coefficient (ppm / °C)	Resistance Tolerance (%)	Resistance Range	Series	Operating Temperature Range (°C)
	(mm)	(inch)								
TRR01	1005	0402	0.063	50	100	+500 / -250	J(±5%)	1Ω to 9.1Ω	E24	-55 to +155
						±200		10Ω to 10MΩ		
						±100	10Ω to 2.2MΩ			
Jumper type : Rmax = 50mΩ / Imax. = 1A										
TRR03	1608	0603	0.1	50	100	±400	J(±5%)	1Ω to 9.1Ω	E24	-55 to +155
						±200		10Ω to 10MΩ		
						±100	10Ω to 10MΩ			
Jumper type : Rmax = 50mΩ / Imax. = 1A										
TRR10	2012	0805	0.125	150	200	±400	J(±5%)	1Ω to 9.1Ω	E24	-55 to +155
						±200		10Ω to 10MΩ		
						±100	10Ω to 2.2MΩ			
Jumper type : Rmax = 50mΩ / Imax. = 2A										
TRR18	3216	1206	0.25	200	400	±400	J(±5%)	1Ω to 9.1Ω	E24	-55 to +155
						±200		10Ω to 10MΩ		
						±100	10Ω to 2.2MΩ			
Jumper type : Rmax = 50mΩ / Imax. = 2A										

*Design and specifications are subject to change without notice.
Carefully check the specification sheet supplied with the product before using or ordering it.

●Part Number Description

T R R	0 1	M Z P	J	1 0 5																										
Part No. TRR (Sulfur Tolerant Chip Resistors)	Size (mm [inch]) 01 (1005 [0402]) 03 (1608 [0603]) 10 (2012 [0805]) 18 (3216 [1206])	Packaging Specifications Code	Resistance Tolerance F (±1%) J (±5%)	Nominal Resistance Resistance code, 3 or 4 digits. 000 denotes jumper type.																										
		<table border="1"> <thead> <tr> <th>Part No.</th> <th>Code</th> <th>Packaging specifications</th> <th>Quantity / Reel</th> </tr> </thead> <tbody> <tr> <td>TRR01</td> <td>MZP</td> <td>Paper tape (2mm Pitch)</td> <td>10,000</td> </tr> <tr> <td>TRR03</td> <td>EZP</td> <td>Paper tape (4mm Pitch)</td> <td>5,000</td> </tr> <tr> <td>TRR10</td> <td>EZP</td> <td>Paper tape (4mm Pitch)</td> <td>5,000</td> </tr> <tr> <td>TRR18</td> <td>EZP</td> <td>Paper tape (4mm Pitch)</td> <td>5,000</td> </tr> </tbody> </table>	Part No.	Code	Packaging specifications	Quantity / Reel	TRR01	MZP	Paper tape (2mm Pitch)	10,000	TRR03	EZP	Paper tape (4mm Pitch)	5,000	TRR10	EZP	Paper tape (4mm Pitch)	5,000	TRR18	EZP	Paper tape (4mm Pitch)	5,000		<table border="1"> <thead> <tr> <th>Resistance tolerance</th> <th>Resistance code</th> </tr> </thead> <tbody> <tr> <td>F</td> <td>: 4 digits</td> </tr> <tr> <td>J</td> <td>: 3 digits</td> </tr> </tbody> </table>	Resistance tolerance	Resistance code	F	: 4 digits	J	: 3 digits
Part No.	Code	Packaging specifications	Quantity / Reel																											
TRR01	MZP	Paper tape (2mm Pitch)	10,000																											
TRR03	EZP	Paper tape (4mm Pitch)	5,000																											
TRR10	EZP	Paper tape (4mm Pitch)	5,000																											
TRR18	EZP	Paper tape (4mm Pitch)	5,000																											
Resistance tolerance	Resistance code																													
F	: 4 digits																													
J	: 3 digits																													
				<p>Ex.)</p> <p>1Ω = 1R0 (±5%) 9.1Ω = 9R1 (±5%) 10Ω = 10R0 (±1%) 100 (±5%) 1MΩ = 1004 (±1%) 105 (±5%)</p>																										

●Chip Resistor Dimensions and Markings

■ TRR01 / 03

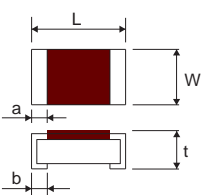

■ TRR10 / 18

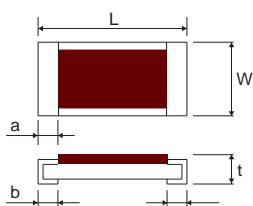

(Unit : mm)

Part No.	(mm)	(inch)	L	W	t	a	b	Marking existence *Including jumper type
TRR01	1005	0402	1.0±0.05	0.5±0.05	0.35±0.05	0.33±0.08	0.25 ^{+0.05} _{-0.1}	No
TRR03	1608	0603	1.6±0.1	0.8±0.1	0.45±0.1	0.4±0.1	0.3±0.2	No
TRR10	2012	0805	2.0±0.1	1.25±0.1	0.55±0.1	0.43 ^{+0.15} _{-0.1}	0.4±0.2	No
TRR18	3216	1206	3.2±0.15	1.6±0.15	0.55±0.1	0.69 ^{+0.2} _{-0.15}	0.5±0.25	No

●Land pattern Example

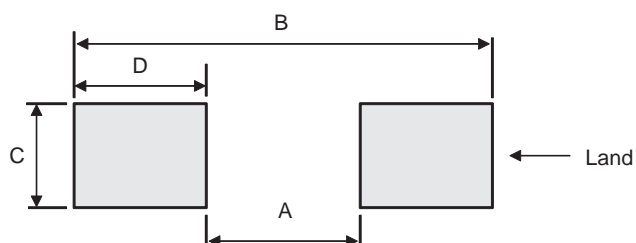

(Unit : mm)

Dimensions Part No.	A	B	C	D
TRR01	0.5	1.3	0.5	0.4
TRR03	1.0	2.0	0.8	0.5
TRR10	1.2	2.6	1.15	0.7
TRR18	2.2	4.0	1.5	0.9

●Derating Curve

When the ambient temperature exceeds 70°C, power dissipation must be adjusted according to the derating curves below.

■ TRR01 / 03 / 10 / 18

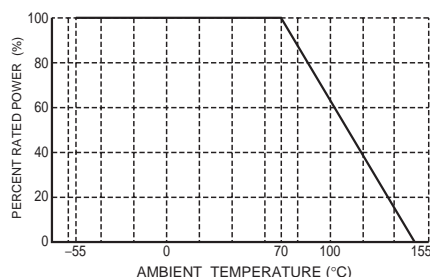

●Characteristics

Test Items	Guaranteed Value		Test Conditions
	Resistor Type	Jumper Type	
Resistance	See P.1		20°C
Variation of resistance with temperature	See P.1		Measurement : +20 / -55 / +20 / +125°C
Overload	± (2.0%+0.1Ω)	Max. 50mΩ	Rated voltage (current) ×2.5, 2s Maximum overload voltage
Solderability	A new uniform coating of minimum of 95% of the surface being immersed and no soldering damage.		Rosin-Ethanol : 25% (Weight) Soldering condition : 235±5°C Duration of immersion : 2.0±0.5s
Resistance to soldering heat	± (1.0%+0.05Ω) No remarkable abnormality on the appearance.	Max. 50mΩ	Soldering condition : 260±5°C Duration of immersion : 10±1s
Rapid change of temperature	± (1.0%+0.05Ω)	Max. 50mΩ	Test temp. : -55°C to +125°C 5cycle
Damp heat, steady state	± (3.0%+0.1Ω)	Max. 100mΩ	40°C, 93%RH (Relative Humidity) Test time : 1,000h to 1,048h
Endurance at 70°C	± (3.0%+0.1Ω)	Max. 100mΩ	70°C Rated voltage (current) 1.5h : ON – 0.5h : OFF Test time : 1,000h to 1,048h
Endurance	± (3.0%+0.1Ω)	Max. 100mΩ	155°C Test time : 1,000h to 1,048h
Resistance to solvent	± (1.0%+0.05Ω)	Max. 50mΩ	23±5°C, Immersion cleaning, 5±0.5min Solvent : 2-propanol
Bend strength of the end face plating	± (1.0%+0.05Ω) Without mechanical damage such as breaks.	Max. 50mΩ	—

Compliance Standard(s) : IEC60115-8
JISC 5201-8

●Chip weight (typical value)

Parameter	Unit	TRR01	TRR03	TRR10	TRR18
Weight	mg/pc	0.70	2.13	5.05	9.51

●Tape Dimensions

■ Paper Tape

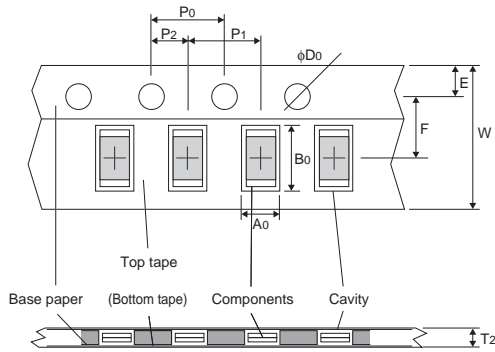

(Unit : mm)

Part No.	W	F	E	A0	B0
TRR01	8.0±0.3	3.5±0.05	1.75±0.1	0.7±0.1	1.2±0.1
TRR03	8.0±0.3	3.5±0.05	1.75±0.1	1.1±0.1	1.9±0.1
TRR10	8.0±0.3	3.5±0.05	1.75±0.1	1.65 ^{+0.2} _{-0.1}	2.4 ^{+0.2} _{-0.1}
TRR18	8.0±0.3	3.5±0.05	1.75±0.1	1.95 ^{+0.1} _{-0.05}	3.5 ^{+0.15} _{-0.05}

Part No.	D0	P0	P1	P2	T2
TRR01	φ1.5 ^{+0.1} ₀	4.0±0.1	2.0±0.05	2.0±0.05	Max 1.1
TRR03	φ1.5 ^{+0.1} ₀	4.0±0.1	4.0±0.1	2.0±0.05	Max 1.1
TRR10	φ1.5 ^{+0.1} ₀	4.0±0.1	4.0±0.1	2.0±0.05	Max 1.1
TRR18	φ1.5 ^{+0.1} ₀	4.0±0.1	4.0±0.1	2.0±0.05	Max 1.1

●Reel Dimensions

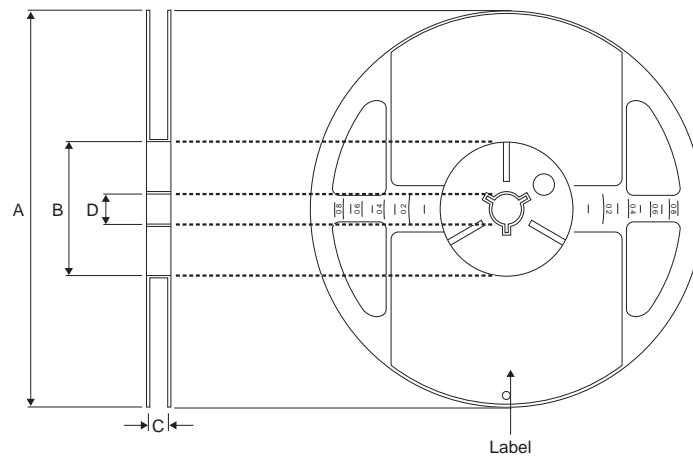

ACCORDING TO EIAJ ET-7200B

(Unit : mm)

Part No.	A	B	C	D
TRR01	φ180 ⁰ _{-1.5}	φ60 ^{+1.0} ₀	9 ^{+1.0} ₀	φ13±0.2
TRR03				
TRR10				
TRR18				

Notes

- 1) The information contained herein is subject to change without notice.
- 2) Before you use our Products, please contact our sales representative and verify the latest specifications :
- 3) Although ROHM is continuously working to improve product reliability and quality, semiconductors can break down and malfunction due to various factors.
Therefore, in order to prevent personal injury or fire arising from failure, please take safety measures such as complying with the derating characteristics, implementing redundant and fire prevention designs, and utilizing backups and fail-safe procedures. ROHM shall have no responsibility for any damages arising out of the use of our Products beyond the rating specified by ROHM.
- 4) Examples of application circuits, circuit constants and any other information contained herein are provided only to illustrate the standard usage and operations of the Products. The peripheral conditions must be taken into account when designing circuits for mass production.
- 5) The technical information specified herein is intended only to show the typical functions of and examples of application circuits for the Products. ROHM does not grant you, explicitly or implicitly, any license to use or exercise intellectual property or other rights held by ROHM or any other parties. ROHM shall have no responsibility whatsoever for any dispute arising out of the use of such technical information.
- 6) The Products are intended for use in general electronic equipment (i.e. AV/OA devices, communication, consumer systems, gaming/entertainment sets) as well as the applications indicated in this document.
- 7) The Products specified in this document are not designed to be radiation tolerant.
- 8) For use of our Products in applications requiring a high degree of reliability (as exemplified below), please contact and consult with a ROHM representative : transportation equipment (i.e. cars, ships, trains), primary communication equipment, traffic lights, fire/crime prevention, safety equipment, medical systems, servers, solar cells, and power transmission systems.
- 9) Do not use our Products in applications requiring extremely high reliability, such as aerospace equipment, nuclear power control systems, and submarine repeaters.
- 10) ROHM shall have no responsibility for any damages or injury arising from non-compliance with the recommended usage conditions and specifications contained herein.
- 11) ROHM has used reasonable care to ensure the accuracy of the information contained in this document. However, ROHM does not warrant that such information is error-free, and ROHM shall have no responsibility for any damages arising from any inaccuracy or misprint of such information.
- 12) Please use the Products in accordance with any applicable environmental laws and regulations, such as the RoHS Directive. For more details, including RoHS compatibility, please contact a ROHM sales office. ROHM shall have no responsibility for any damages or losses resulting from non-compliance with any applicable laws or regulations.
- 13) When providing our Products and technologies contained in this document to other countries, you must abide by the procedures and provisions stipulated in all applicable export laws and regulations, including without limitation the US Export Administration Regulations and the Foreign Exchange and Foreign Trade Act.
- 14) This document, in part or in whole, may not be reprinted or reproduced without prior consent of ROHM.



Thank you for your accessing to ROHM product informations.
More detail product informations and catalogs are available, please contact us.

ROHM Customer Support System

<http://www.rohm.com/contact/>