

VJ 3505 UHF Chip Antenna for Mobile Devices



The company's products are covered by one or more of the following:

WO2008250262 (A1), US2008303720 (A1),
US2008305750 (A1), WO2008154173 (A1).

Other patents pending.

DESCRIPTION

The VJ 3505 multi-layer ceramic chip antenna is a small form-factor, high-performance, chip-antenna designed for TV reception in mobile devices in the UHF band. It allows mobile TV device manufacturers to design high quality products that do not bear the penalty of a large external antenna. Utilizing Vishay's unique materials and manufacturing technologies, this product complies with the MBRAI standard while maintaining a small outline.

Focusing on consumer applications, the antenna is designed to be assembled onto a PC board in the standard reflow process.

Target customers of the VJ 3505 are mobile phone makers, portable multimedia device makers, notebook OEMs and ODMs, and accessory card OEMs and ODMs.

FEATURES

- Small outline (35 mm x 5 mm x 1.2 mm)
- Omni-directional, linear polarization
- Complies with MBRAI standard
- Complete UHF band coverage (470 MHz to 860 MHz) up to 1.1 GHz
- Requires a tuning circuit and ground plane for optimal performance
- Standard SMT assembly
- 50 Ω unbalanced interface
- Operating temperature range (- 40 °C to + 85 °C)
- Reference design and evaluation boards available upon request
- Compliant to RoHS directive 2002/95/EC

RoHS
COMPLIANT

APPLICATIONS

- Mobile UHF TV receivers including DVB-T, DVB-H, ISDB-T, CMMB, ATSC, and MediaFLO devices

ANTENNA PERFORMANCE

Peak gain and efficiency

The antenna radiation characteristics are influenced by several factors including ground plane dimensions and impedance matching network.

The antenna parameters presented hereafter were simulated according to the ground plane configuration suggested by the VJ 3505 evaluation board.

Figure 1. shows simulated peak gain and radiation efficiency over frequency throughout the UHF band, compared with the MBRAI requirements.

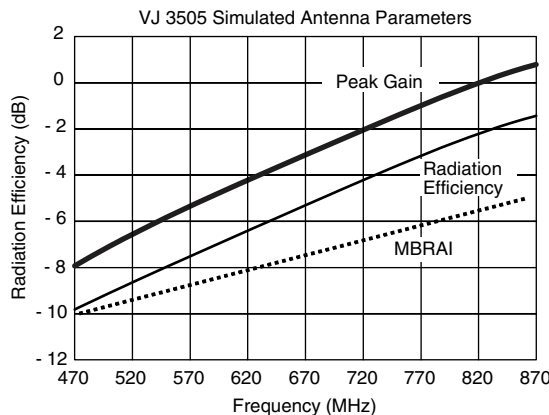

Fig. 1 - Peak Gain and Efficiency vs. Frequency

RADIATION PATTERN

The 3D planes of VJ 3505 are defined in figure 2.

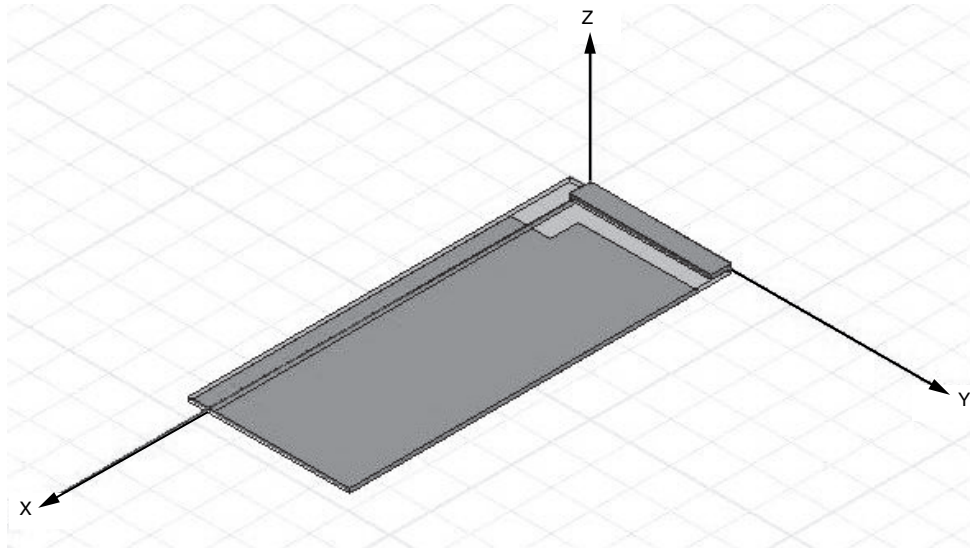

Fig. 2 - VJ 3505 3D Plane Definition

Figure 3. displays the simulated 3D radiation pattern at 550 MHz. The general pattern shape does not change with frequency.

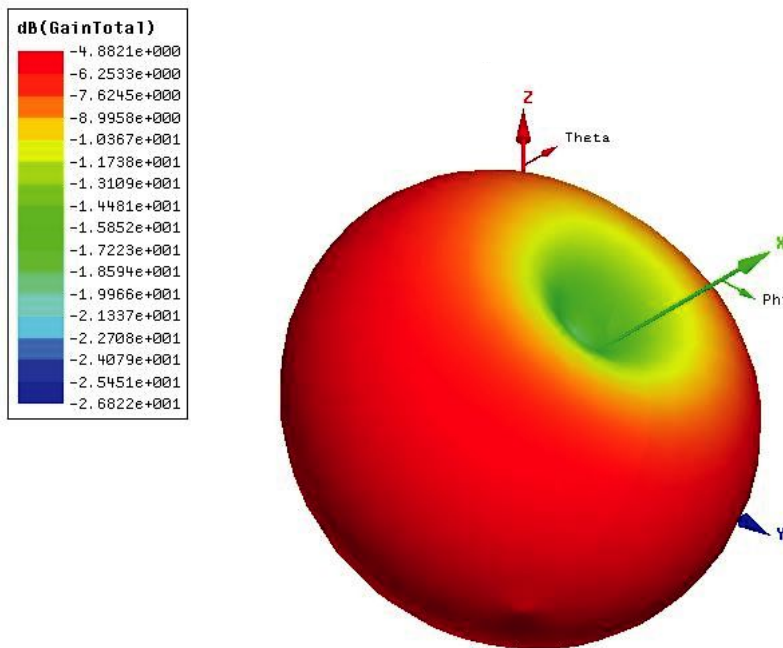

Fig. 3 - Simulated Radiation Pattern at 550 MHz

Fig. 4 displays the measured radiation patterns of VJ 3505 evaluation board in the YZ plane as defined in Fig. 2. Zero degrees is defined at the Z axis, stepping clockwise.

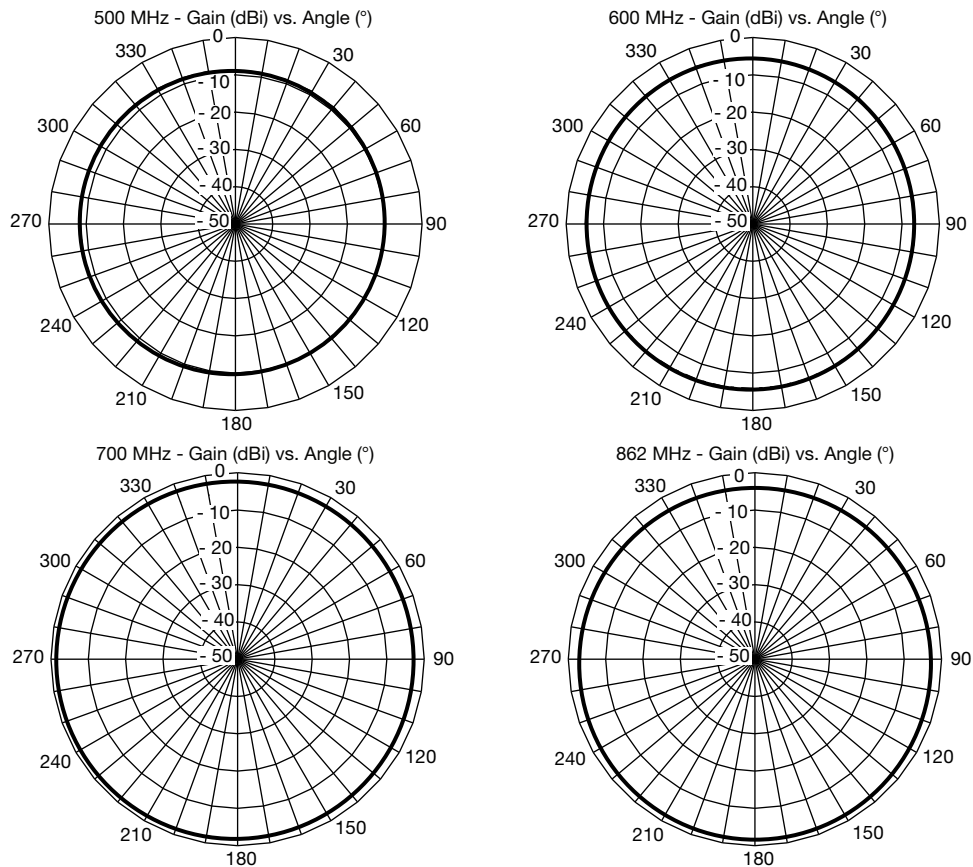

Fig. 4 - Measured Radiation Pattern

FOOTPRINT AND MECHANICAL DIMENSIONS

The antenna footprint and mechanical dimensions are presented in figure 5. For mechanical support, it is recommended to add one or two drops of heat curing epoxy glue. The glue dot should not overlap with any of the soldering pads. It is recommended to apply the glue dot at the center of the antenna, as shown by the diagonal pattern. For more details see “VJ 3505 assembly guidelines” section below.

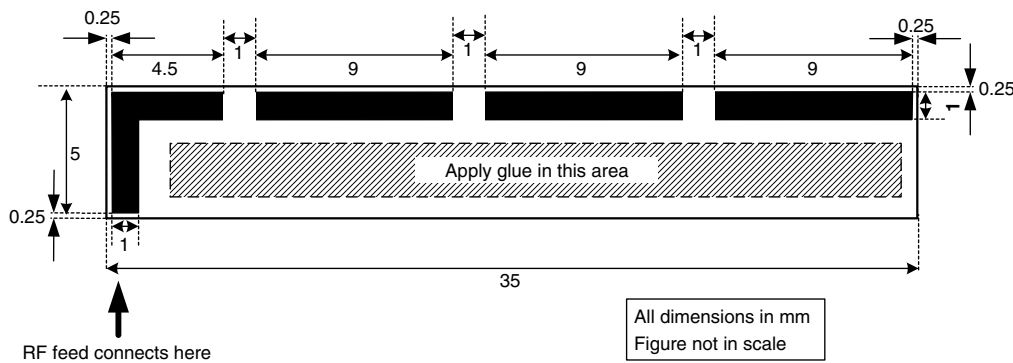

Fig. 5 - VJ 3505 Footprint

| DIMENSIONS | (mm) |
|------------|-------------|
| Length | 35 + 0.5/-0 |
| Width | 5 + 0.5/-0 |
| Height | 1.2 ± 0.1 |

VJ 3505 ASSEMBLY GUIDELINES

1. Mounting of antennas on a printed circuit board should be done by reflow soldering. The reflow soldering profiles are shown below.
2. In order to provide the adequate strength between the antenna and the PCB the application of a dot of heat cured epoxy glue in the center of the footprint of the antenna prior to the antenna's soldering to the board should be done. An example for such glue could be Heraeus PD 860002 SA. The weight of the dot should be 5 mg to 10 mg.

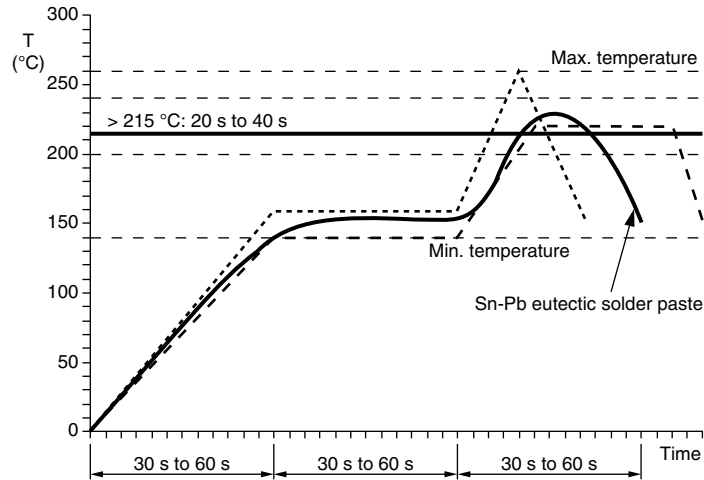

Fig. 6 - Soldering IR Reflow with SnPb Solder

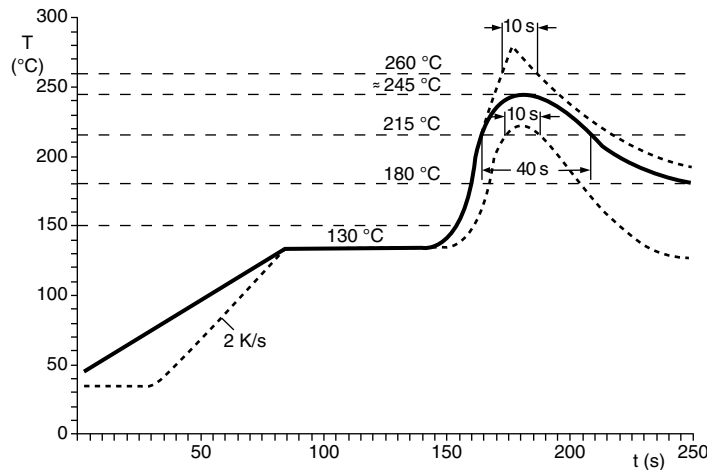

Fig. 7 - Soldering Reflow with Sn Solder

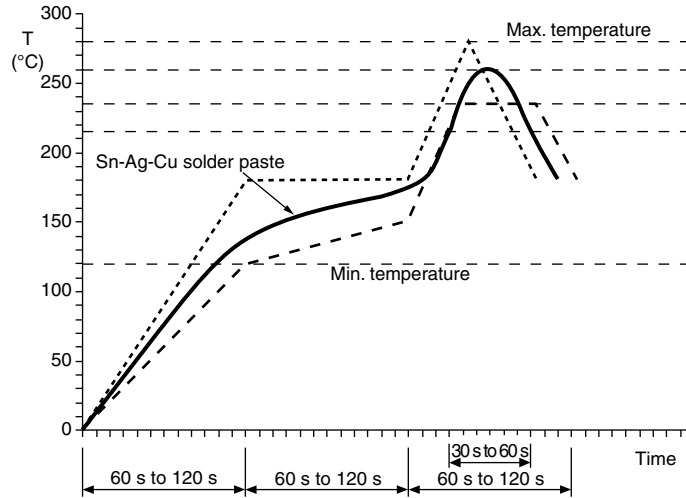

Fig. 8 - Soldering IR Reflow with SnAgCu Solder

| ORDERING INFORMATION | VISHAY MATERIAL | PACKAGING QUANTITY |
|----------------------|-------------------|--------------------|
| VJ 3505 | VJ3505M011SXMSRA0 | 1000 pieces |



Disclaimer

ALL PRODUCT, PRODUCT SPECIFICATIONS AND DATA ARE SUBJECT TO CHANGE WITHOUT NOTICE TO IMPROVE RELIABILITY, FUNCTION OR DESIGN OR OTHERWISE.

Vishay Intertechnology, Inc., its affiliates, agents, and employees, and all persons acting on its or their behalf (collectively, "Vishay"), disclaim any and all liability for any errors, inaccuracies or incompleteness contained in any datasheet or in any other disclosure relating to any product.

Vishay makes no warranty, representation or guarantee regarding the suitability of the products for any particular purpose or the continuing production of any product. To the maximum extent permitted by applicable law, Vishay disclaims (i) any and all liability arising out of the application or use of any product, (ii) any and all liability, including without limitation special, consequential or incidental damages, and (iii) any and all implied warranties, including warranties of fitness for particular purpose, non-infringement and merchantability.

Statements regarding the suitability of products for certain types of applications are based on Vishay's knowledge of typical requirements that are often placed on Vishay products in generic applications. Such statements are not binding statements about the suitability of products for a particular application. It is the customer's responsibility to validate that a particular product with the properties described in the product specification is suitable for use in a particular application. Parameters provided in datasheets and/or specifications may vary in different applications and performance may vary over time. All operating parameters, including typical parameters, must be validated for each customer application by the customer's technical experts. Product specifications do not expand or otherwise modify Vishay's terms and conditions of purchase, including but not limited to the warranty expressed therein.

Except as expressly indicated in writing, Vishay products are not designed for use in medical, life-saving, or life-sustaining applications or for any other application in which the failure of the Vishay product could result in personal injury or death. Customers using or selling Vishay products not expressly indicated for use in such applications do so at their own risk. Please contact authorized Vishay personnel to obtain written terms and conditions regarding products designed for such applications.

No license, express or implied, by estoppel or otherwise, to any intellectual property rights is granted by this document or by any conduct of Vishay. Product names and markings noted herein may be trademarks of their respective owners.

Material Category Policy

Vishay Intertechnology, Inc. hereby certifies that all its products that are identified as RoHS-Compliant fulfill the definitions and restrictions defined under Directive 2011/65/EU of The European Parliament and of the Council of June 8, 2011 on the restriction of the use of certain hazardous substances in electrical and electronic equipment (EEE) - recast, unless otherwise specified as non-compliant.

Please note that some Vishay documentation may still make reference to RoHS Directive 2002/95/EC. We confirm that all the products identified as being compliant to Directive 2002/95/EC conform to Directive 2011/65/EU.

Vishay Intertechnology, Inc. hereby certifies that all its products that are identified as Halogen-Free follow Halogen-Free requirements as per JEDEC JS709A standards. Please note that some Vishay documentation may still make reference to the IEC 61249-2-21 definition. We confirm that all the products identified as being compliant to IEC 61249-2-21 conform to JEDEC JS709A standards.